

# CS-119/P2202 Series

19" TFT-LCD SXGA 5:4 Sunlight Readable Modular / Expandable Panel PC with 12th Gen. Intel® Core™ i5 / i3 Processor & Projected Capacitive Touch



## HIGH-PERFORMANCE SUNLIGHT READABLE PANEL PC

| CS-100/P2000 Series |

### Overview

 CONTACT

The CS-100/P2202 series is a sunlight-readable high-performance panel PC that provides ultra-high brightness of up to 1,800 nits. It is equipped with an Intel® Core™ U-series (Alder Lake-P) processor that provides a complete selection of screen sizes, ratios, and brightnesses. Rich I/O, flexible expansion, rugged, easy on-site maintenance, and other features make the CS-100/P2202 series the best choice for outdoor kiosk or HMI applications.

### Key Features

- 19" TFT-LCD with Projected Capacitive Touch
- Onboard Intel® Alder Lake-P U-Series Core™ Processor
- 2x DDR5 SO-DIMM Socket, Supports up to 4800MHz 64GB Memory
- Ultra High Brightness up to 1,600 nits
- Quad Independent Display (CDS / HDMI / DP / VGA)
- 1x M.2 Key E Type 2230 Socket for Intel CNVi / Wireless Module
- Designed with Aluminum Die-cast Front Bezel
- Front Panel IP65 Compliant

### Certifications



### Excellent Computing Performance

The CS-100/P2202 series is equipped with the 12th Gen Intel® Core™ i5/i3 U-series (Alder Lake-P) processor based on the Intel® 7 process. The U-series has a low power consumption of only 15W, boasts excellent performance with up to 10 cores (2P+8E), and includes the built-in Intel® Iris Xe graphics to easily handle image classification inference performance in AI deep learning.

#### i5 Processor

12th Gen Alder Lake i5-1245UE

**+2.23X** ↗

8th Gen. Whiskey i5-8365UE

#### i3 Processor

12th Gen Alder Lake i3-1215UE

**+1.62X** ↗

8th Gen. Whiskey i3-8145UE



### CDS Patented Technology

Cincoze Convertible Display System (CDS) patented technology makes field-side maintenance and future upgrades easier. Replacing a display or improving system performance only requires replacing a single component, which significantly cuts upgrade costs.

Patent No. M482908

### Complete Range of Sizes

The CS-100/P2202 series offers a variety of display options, with screen sizes from 12 to 24 inches, support for up to full HD resolution, high brightness up to 1,800 nits, and multi-point P-Cap touchscreen, which can be selected according to application needs.



### Wide Temps, Safe, Reliable

In order to overcome the harsh outdoor environment and unpredictable climate, the CS-100/P2202 series has a series of industrial-grade protections, including a wide operating temperature range (-20°C to 70°C) that beats the industry standard and an IP65 dustproof/water resistant front panel to ensure a high degree of product safety.

## CS-119 Specifications

Model Name	CS-119
<b>Display</b>	
LCD Size	• 19" (5:4)
Max. Resolution	• 1280 x 1024 (SXGA)
Brightness (cd/m2)	• 1600
Contrast Ratio	• 1000 : 1
LCD Color	• 16.7M
Pixel Pitch (mm)	• 0.294 (H) x 0.294 (V)
Viewing Angle (H-V)	• 170 / 160
Backlight MTBF	• 50,000 hrs (LED Backlight)
<b>Touch Screen</b>	
Touch Type	• Projected Capacitive
<b>Physical</b>	
Dimension ( W x D x H )	• 510 x 389.3 x 63.2 mm
Weight Information	• 6.96 kg
Mechanical Construction	• Flat Rugged Aluminum Die-casting Bezel
<b>Environment</b>	
Front Panel Protection	• IP 65 Compliant
Operating Temperature	• -20°C to 70°C (With Industrial Grade Peripherals; Ambient with air flow)
Storage Temperature	• -30°C to 70°C
Relative Humidity	• 90% RH @ 40°C (Non-condensing)
EMC	• CE, UKCA, FCC, ICES-003 Class A
EMI	<ul style="list-style-type: none"> <li>• CISPR 32 Conducted &amp; Radiated: Class A</li> <li>• EN/BS EN 55032 Conducted &amp; Radiated: Class A</li> <li>• EN/BS EN IEC 61000-3-2 Harmonic current emissions: Class A</li> <li>• EN/BS EN61000-3-3 Voltage fluctuations &amp; flicker</li> <li>• FCC 47 CFR Part 15B, ICES-003 Conducted &amp; Radiated: Class A</li> </ul>
EMS	<ul style="list-style-type: none"> <li>• EN/IEC 61000-4-2 ESD: Contact: 4 kV; Air: 8 kV</li> <li>• EN/IEC 61000-4-3 RS: 80 MHz to 1000 MHz: 3 V/m</li> <li>• EN/IEC 61000-4-4 EFT: AC Power: 1 kV; DC Power: 0.5 kV; Signal: 0.5 kV</li> <li>• EN/IEC 61000-4-5 Surges: AC Power: 2 kV; Signal: 1 kV</li> <li>• EN/IEC 61000-4-6 CS: 3V</li> <li>• EN/IEC 61000-4-8 PFMF: 50 Hz, 1A/m</li> <li>• EN/IEC 61000-4-11 Voltage Dips &amp; Voltage Interruptions: 0.5 cycles at 50 Hz</li> </ul>
Safety	• UL, cUL, CB, IEC, EN 62368-1

## P2202 Specifications

Model Name	P2202	P2202E
<b>System</b>		
Processor	<ul style="list-style-type: none"> <li>Onboard 12th Generation Intel® Alder Lake-P U-Series CPU:                             <ul style="list-style-type: none"> <li>Intel® Core™ i5-1245UE 10 Cores Up to 4.40 GHz, TDP 15W</li> <li>Intel® Core™ i3-1215UE 6 Cores Up to 4.40 GHz, TDP 15W</li> </ul> </li> </ul>	
Memory	<ul style="list-style-type: none"> <li>2x DDR5 4800MHz SO-DIMM Socket</li> <li>Supports Un-buffered and non-ECC Type, Up to 64GB</li> </ul>	
BIOS	<ul style="list-style-type: none"> <li>AMI BIOS</li> </ul>	
<b>Graphics</b>		
Graphics Engine	<ul style="list-style-type: none"> <li>Integrated Intel® Iris® Xe Graphics: Core™ i5-1245UE</li> <li>Integrated Intel® UHD Graphics: Core™ i3-1215UE</li> </ul>	
Maximum Display Output	<ul style="list-style-type: none"> <li>Supports Quad Independent Display</li> </ul>	
CDS	<ul style="list-style-type: none"> <li>1x CDS Connector (1920 x 1080 @60Hz)</li> </ul>	
DP	<ul style="list-style-type: none"> <li>1x DisplayPort Connector (4096 x 2304 @60Hz)</li> <li>* Verified maximum resolution: 3840 x 2160 @ 60Hz</li> </ul>	
HDMI	<ul style="list-style-type: none"> <li>1x HDMI Connector (3840 x 2160 @30Hz)</li> </ul>	
VGA	<ul style="list-style-type: none"> <li>1x VGA Connector (1920 x 1200 @60Hz)</li> </ul>	
<b>Audio</b>		
Audio Codec	Realtek® ALC888, High Definition Audio	
Line-out	<ul style="list-style-type: none"> <li>1x Line-out, Phone Jack 3.5mm</li> </ul>	
Mic-in	<ul style="list-style-type: none"> <li>1x Mic-in, Phone Jack 3.5mm</li> </ul>	
<b>I/O</b>		
LAN	<ul style="list-style-type: none"> <li>2x 1GbE LAN, RJ45</li> <li>- GbE1: Intel® I219</li> <li>- GbE2: Intel® I210</li> </ul>	
COM	<ul style="list-style-type: none"> <li>4x RS-232/422/485 with Auto Flow Control (Supports 5V/12V), DB9</li> </ul>	
USB	<ul style="list-style-type: none"> <li>3 x USB 3.2 Gen2x1 (10Gbps), Type A</li> <li>1 x USB 2.0 (480Mbps), Type A</li> </ul>	
DIO	<ul style="list-style-type: none"> <li>16x Isolated Digital I/O (8in/8out), 20-Pin Terminal Block</li> </ul>	
<b>Storage</b>		
SSD/HDD	<ul style="list-style-type: none"> <li>2x 2.5" SATA HDD/SSD Bay (SATA3.0)</li> </ul>	
RAID	<ul style="list-style-type: none"> <li>Support RAID 0/1</li> </ul>	
<b>Expansion</b>		
Mini PCI Express	<ul style="list-style-type: none"> <li>2x Full-size Mini-PCIe Socket</li> </ul>	
PCI Express		<ul style="list-style-type: none"> <li>1x PCI or 1x PCIe x4 Expansion slot (with Optional Riser Card)</li> <li>* Supports maximum dimensions of add-on card (H x L) : 111 x 169mm</li> </ul>
SIM Socket	<ul style="list-style-type: none"> <li>1x SIM Socket</li> </ul>	
M.2	<ul style="list-style-type: none"> <li>1x M.2 Key E Type 2230 Socket, Support Intel CNVi/Wireless Module</li> </ul>	
CFM (Control Function Module) Interface	<ul style="list-style-type: none"> <li>1x CFM Interface for optional IGN Module Expansion</li> <li>1x CFM Interface for optional PoE Module Expansion</li> </ul>	

CDS (Convertible Display System) Interface	• 1x CDS Interface for Convertible Display Module	
<b>Other Function</b>		
Clear CMOS Switch	• 1x Clear CMOS Switch	
Reset Button	• 1x Reset Button	
Instant Reboot	• Support 0.2sec Instant Reboot Technology	
Watchdog Timer	• Software Programmable Supports 256 Levels System Reset	
OSD Button	• LCD On/Off, Brightness Up, Brightness Down	
Internal Speaker	• AMP 2W + 2W	
Status LED Indicator	• Power LED, HDD LED	
<b>Power</b>		
Power Button	• 1x ATX Power On/Off Button	
Power Mode Switch	• 1x AT/ATX Mode Switch	
Power Input	• 9 - 48VDC, 3-pin Terminal Block	
Remote Power On/Off	• 1x Remote Power On/Off, 2-pin Terminal Block	
<b>Operating System</b>		
Windows	• Windows®11, Windows®10	
Linux	• Ubuntu 22.04	
<b>Physical</b>		
Dimension( W x D x H )	• 254.5 x 190 x 41.5 mm	• 254.5 x 190 x 61 mm
Weight Information	• 2.22 kg	• 2.74 kg
Mechanical Construction	• Extruded Aluminum with Heavy Duty Metal	
Mounting	• Wall / VESA / CDS / DIN Rail	
Physical Design	• Fanless Design • Jumper-less Design	
<b>Reliability &amp; Protection</b>		
Reliability & Protection	• Yes	
Reverse Power Input Protection	• Protection Range: 51~58V • Protection Type: shut down operating voltage, re-power on at the preset level to recover	
Over Current Protection	• 15A	
CMOS Battery Backup	• SuperCap Integrated for CMOS Battery Maintenance-free Operation	
MTBF	• 216,747 Hours - Database: Telcordia SR-332 Issue3, Method 1, Case 3	
<b>Environment</b>		
Operating Temperature	• -40°C to 70°C * With extended temperature peripherals; Ambient with air flow * According to IEC60068-2-1, IEC60068-2-2, IEC60068-2-14	
Storage Temperature	• -40°C to 70°C	
Relative Humidity	• 95%RH @ 70°C (non-Condensing)	
Shock	• Operating, 50 Grms (w/ SSD, according to IEC60068-2-27)	
Vibration	• Operating, 1 Grms, 10-500 Hz, 3 Axes (w/ SSD, according to IEC60068-2-6) • Operating, 5 Grms, 5-500 Hz, 3 Axes (w/ SSD, according to IEC60068-2-64)	

EMC	<ul style="list-style-type: none"> <li>• CE, UKCA, FCC, ICES-003 Class A</li> <li>• EN IEC 61000-6-4, EN IEC 61000-6-2(24VDC Input Only)</li> </ul>
EMI	<ul style="list-style-type: none"> <li>• CISPR 32 Conducted &amp; Radiated: Class A</li> <li>• EN/BS EN 55032 Conducted &amp; Radiated: Class A</li> <li>• EN/BS EN IEC 61000-3-2 Harmonic current emissions: Class A</li> <li>• EN/BS EN61000-3-3 Voltage fluctuations &amp; flicker</li> <li>• FCC 47 CFR Part 15B, ICES-003 Conducted &amp; Radiated: Class A</li> </ul>
EMS	<ul style="list-style-type: none"> <li>• EN/IEC 61000-4-2 ESD: Contact: 4 kV; Air: 8 kV</li> <li>• EN/IEC 61000-4-3 RS: 80 MHz to 1000 MHz: 10 V/m</li> <li>• EN/IEC 61000-4-4 EFT: AC Power: 2 kV; DC Power: 1 kV; Signal: 1 kV</li> <li>• EN/IEC 61000-4-5 Surges: AC Power: 2 kV; Signal: 1 kV</li> <li>• EN/IEC 61000-4-6 CS: 10V</li> <li>• EN/IEC 61000-4-8 PFMF: 50 Hz, 30A/m</li> <li>• EN/IEC 61000-4-11 Voltage Dips &amp; Voltage Interruptions: 1 cycles at 60 Hz</li> </ul>
Safety	<ul style="list-style-type: none"> <li>• UL, cUL, CB, IEC/EN 62368-1</li> </ul>

**CS-119/P2202 External Layout**

Front I/O

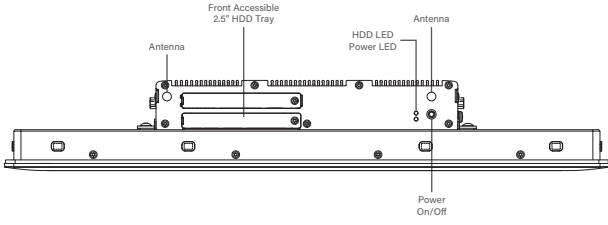

Rear I/O

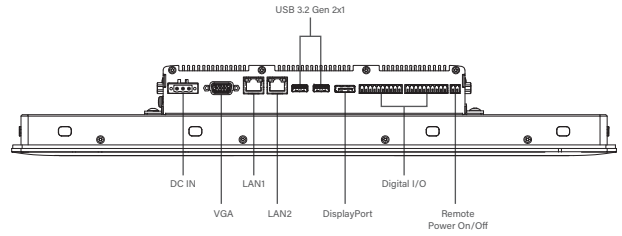

Left I/O

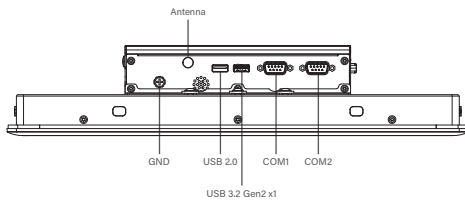

Right I/O

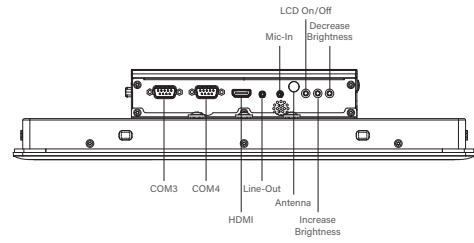

**CS-119/P2202E External Layout**

Front I/O

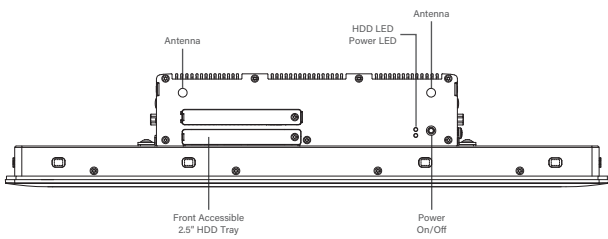

Rear I/O

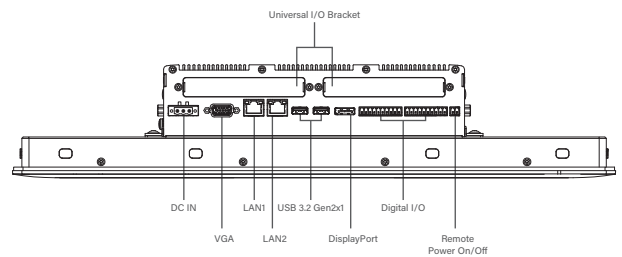

Left I/O

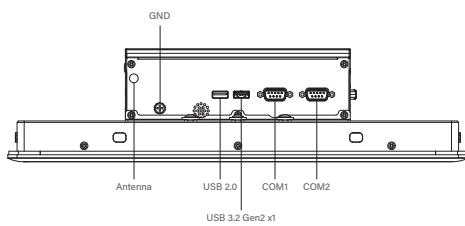

Right I/O

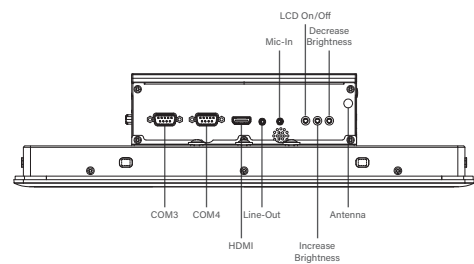

**CS-119/P2202 Dimensions**

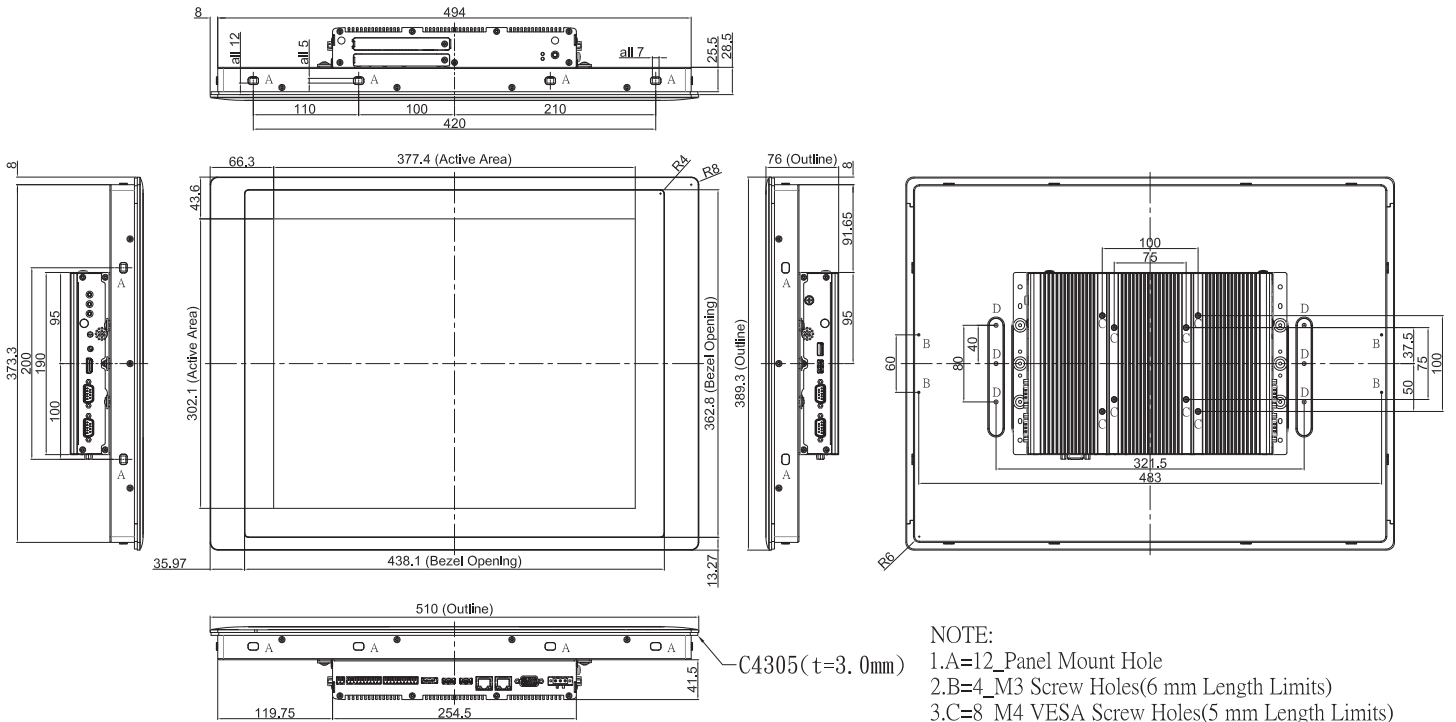

**CS-119/P2202E Dimensions**

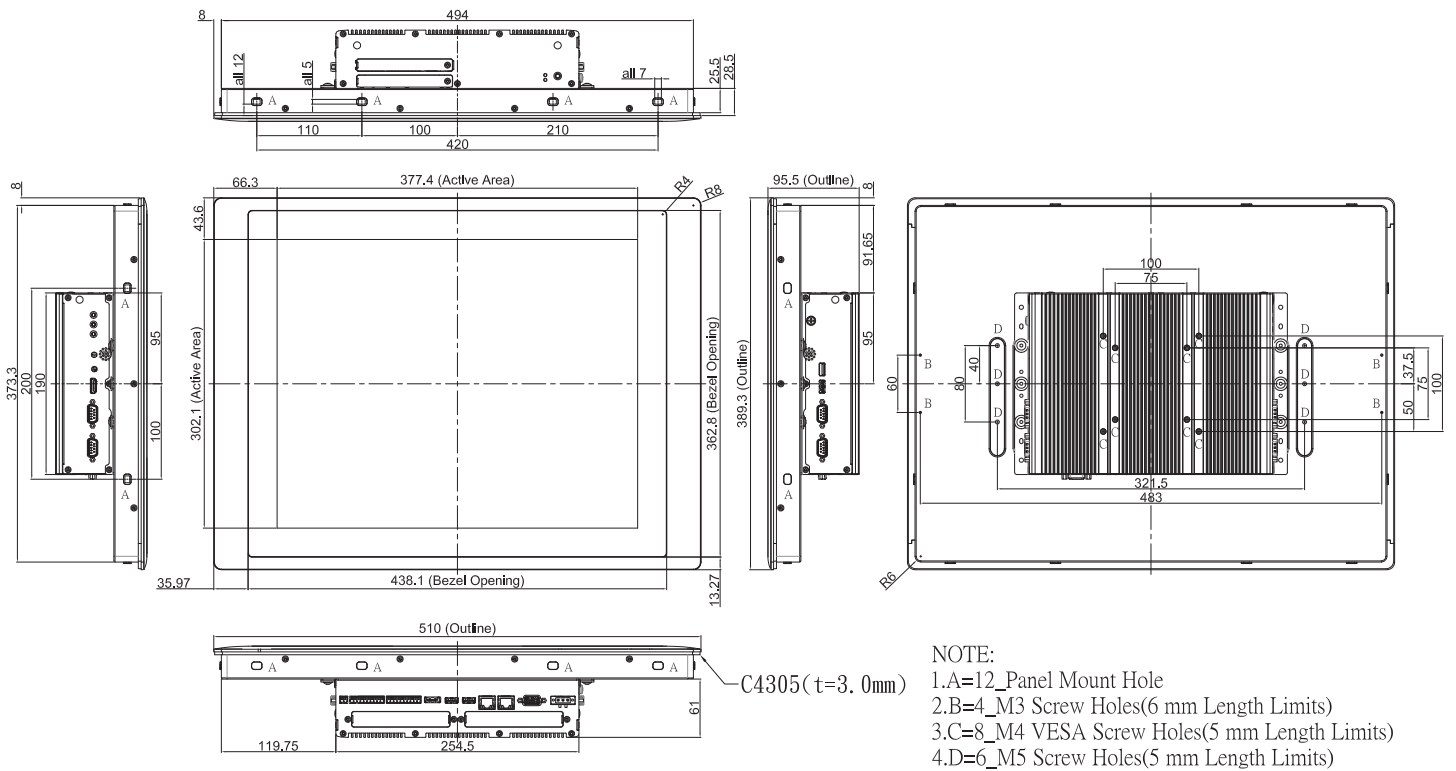



## Ordering Information

### Available Models

Model No.	Description
CS-119C-R11/P2202-i5-R10	19" TFT-LCD 1600 nits SXGA 5:4 Display Modular Panel PC with 12th Gen. Intel® Core™ i5-1245UE Processor and Projected Capacitive Touch
CS-119C-R11/P2202E-i5-R10	19" TFT-LCD 1600 nits SXGA 5:4 Display Modular and Expandable Panel PC with 12th Gen. Intel® Core™ i5-1245UE Processor and Projected Capacitive Touch
CS-119C-R11/P2202-i3-R10	19" TFT-LCD 1600 nits SXGA 5:4 Display Modular Panel PC with 12th Gen. Intel® Core™ i3-1215UE Processor and Projected Capacitive Touch
CS-119C-R11/P2202E-i3-R10	19" TFT-LCD 1600 nits SXGA 5:4 Display Modular and Expandable Panel PC with 12th Gen. Intel® Core™ i3-1215UE Processor and Projected Capacitive Touch

### Model Configuration

	CS-119C	P2202(i3/i5)	P2202E(i3/i5)
CS-119C/P2202	V	V	--
CS-119C/P2202E	V	--	V

V : Compatible

### Package Checklist





• CS-119/P2202 Series Panel PC x1	• Thermal Pad x1
• Power Terminal Block x1	• Screw Pack x5
• Remote Power On/Off Terminal Block Connector x1	• Panel Mounting Kit x1
• DIO Terminal Block Connector x2	• DIN Rail Mounting Kit x1
• PCI / PCIe Card Installation Kit x1 (For P2202E Only)	

**Optional Modules and Accessories**

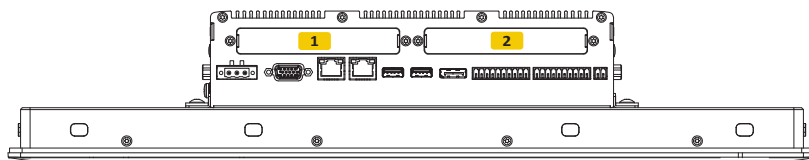
Model No.	Description
CFM-IGN101	CFM Module with Power Ignition Sensing Control Function, 12V/24V Voltage Detection Selectable
CFM-PoE04	CFM Module with PoE Control Function, Individual Port 25.5W (For P2202 Only)
CFM-PoE05	CFM Module with PoE Control Function, Individual Port 25.5W (For P2202E Only)
RC-E4-02	Riser Card with 1x PCIe x4 Slot (For P2202E Only)
RC-PI-02	Riser Card with 1x PCI Slot (For P2202E Only)
MEC-COM-M212-TDB9	Mini-PCIe Module with 2x RS-232 Ports, 1x Thin DB9 Cable (For P2202E Only)
MEC-COM-M334-TDB9	Mini-PCIe Module with 4x RS-232/422/485 Ports, 2x Thin DB9 Cable (For P2202E Only)
MEC-USB-M102-30	Mini-PCIe Module with 2x USB 3.0 Ports, 1x 30cm cable (For P2202E Only)
MEC-LAN-M102-30	Mini-PCIe Module with 2x LAN Ports, 2x 30cm cable (For P2202E Only)
UB1203	1x Universal Bracket with 2x DB9 Cutout (For P2202E Only)
UB1211	1x Universal Bracket with 2x RJ45 Cutout (For P2202E Only)
UB1214	1x Universal Bracket with 2x USB Cutout (For P2202E Only)
URM01	Universal 19" Rack Mount Kit for Industrial Panel PC & Industrial Monitor
GST60A12-CIN1	Adapter AC/DC 12V 5A 60W, GST60A12-CIN, wide temp (-30°C ~ +70°C), level VI
GST120A24-CIN	Adapter AC/DC 24V 5A 120W with 3pin Terminal Block Plug and Tubes, Level VI
GST220A24-CIN	Adapter AC/DC 24V 9.2A 220W with 3pin Terminal Block Plug 5.0mm Pitch, with TUBES, level VI (For P2202E Only)

**Optional Module Configuration (For P2202E only)**



Model No.	Description	1	2
 MEC-COM-M212-TDB9/UB1203	Mini-PCIe Module with 2x RS-232 Ports, 1x Thin DB9 Cable / 1x Universal Bracket with 2x DB9 Cutout	V	V
 MEC-COM-M334-TDB9/UB1203	Mini-PCIe Module with 4x RS-232/422/485 Serial Ports/ 2x Universal Bracket each with 2x DB9 Cutout	V	V
 MEC-LAN-M102-30/UB1211	Mini-PCIe Module with 2x LAN Ports, 2x 30cm cable / 1x Universal Bracket with 2x RJ45 Cutout	V	V
 MEC-USB-M102-30/UB1214	Mini-PCIe Module with 2x USB 3.2 Gen1 Ports, 1x 30cm cable / 1x Universal Bracket with 2x USB Cutout	V	V

V : Compatible

Updated: Mar. 29, 2024