

DA-1100

Intel® Pentium® N4200 / Celeron® N3350 Processor Affordable Fanless Embedded Computer



Overview

[CONTACT](#)

Cincoze' DA-1100 affordable fanless embedded computer is based on the Intel® Pentium® N4200 / Celeron® N3350 processor. This mainstream Intel® SoC (Apollo Lake) integrates the Intel® Gen 9 graphics architecture with triple display support in 4K/2K UHD resolution. DA-1100 supports both Combined Multiple I/O (CMI) and Control Function Module (CFM) which are specially designed for flexible I/O and function expandabilities, such as COM ports, optical isolated digital I/O, LPT/PS2, HDMI, DisplayPort, DVI-D, VGA, and Power over Ethernet (PoE).

Leveraging a reliable fanless and durable cable-free design in an ultra-compact aluminum housing, DA-1100 is ideally for deployment in space-constrained place and continuous operation under harsh environments.

Key Features

- Onboard Intel® Pentium® N4200 / Celeron® N3350 Processor
- Supports Triple Independent Display
- Supports PoE+ Function (with optional CFM module)
- Supports CMI Interface for I/O Expandability
- 1x 2.5" SATA Drive Bay, 1x mSATA Socket
- 2x Full Size Mini-PCIe Socket, 1x SIM Card Socket
- Ultra Compact Size (150 x 105 x 52.3 mm)
- Wide Operating Temperature -40°C to 70°C
- Safety: UL, cUL, CB, IEC/EN62368-1

Certifications



Ultra Compact & Powerful

DA-1100 is powered by Intel Apollo Lake SoC (up to 4 core, 2.5 GHz) and constructed with a palm-sized aluminum housing. It can be easily installed into a control cabinet or any other space-limited environments.



Triple Displays

DA-1100 offers enhanced graphics performance to enable three simultaneous displays and support 4K/2K UHD resolution. The third display output can be added via CMI module and is available with VGA, DisplayPort, HDMI, or DVI-D.

Power over Ethernet

By utilizing optional Cincoze Control Function Module (CFM), the system can add power over ethernet (PoE+) function with up to 25.5W per port. It is ideal for applications like machine vision or video surveillance.



Specifications

Model Name	DA-1100
System	
Processor	<ul style="list-style-type: none"> Onboard Intel® Pentium® N4200 Quad Core Processor, up to 2.50 GHz Onboard Intel® Celeron® N3350 Dual Core Processor, up to 2.40 GHz
BIOS	<ul style="list-style-type: none"> AMI BIOS, 8MB SPI Flash ROM built on board
Memory	<ul style="list-style-type: none"> 1x DDR3L 1333/1600/1866 MHz SO-DIMM Sockets Supports Un-buffered and Non-ECC Type Up to 8 GB
Graphics	
Graphics Engine	<ul style="list-style-type: none"> Integrated Intel® HD Graphics 505 (Pentium® N4200) Integrated Intel® HD Graphics 500 (Celeron® N3350) Supports Triple Independent Display (DVI-D + VGA from DVI-I, one output from optional CMI module)
Audio	
Audio Codec	<ul style="list-style-type: none"> Realtek ALC888-GR
I/O	
Connector	<ul style="list-style-type: none"> 1x DVI-I (1920 x 1080 @60Hz)
LAN	<ul style="list-style-type: none"> 2x GbE LAN (Supports WoL, Teaming, Jumbo Frame & PXE), RJ45 - GbE1: Intel® I210 - GbE2: Intel® I210
USB	<ul style="list-style-type: none"> 4x USB3.2 Gen1 (Type A) 1x USB 2.0 (Type A)
Auto Flow Control	<ul style="list-style-type: none"> 2x RS-232/422/485 with , DB9
Mic-in	<ul style="list-style-type: none"> 1x Line-out & 1x Mic-in, Phone Jack 3.5mm
Power On/Off Button	<ul style="list-style-type: none"> 1x ATX Power On/Off Button
Mode Switch	<ul style="list-style-type: none"> 1x AT/ATX Mode Switch
Clear CMOS Switch	<ul style="list-style-type: none"> 1x Clear CMOS Switch
Remote Power On/Off Connector	<ul style="list-style-type: none"> 1x Remote Power On/Off Connector, 2-pin Terminal Block
Storage	
SSD / HDD	<ul style="list-style-type: none"> 1x 2.5" HDD/SSD or 1x Half-Slim SSD (SATA 3.0) * The 2.5" HDD/SSD bracket has to be removed when installing Mini-PCIe MEC LAN Module or Half Slim SSD.
mSATA	<ul style="list-style-type: none"> 1x mSATA (SATA 3.0, Shared by Mini-PCIe Socket)
Expansion	
Mini PCIe	<ul style="list-style-type: none"> 2x Full-size Mini-PCIe Socket
SIM Socket	<ul style="list-style-type: none"> 1x SIM Card Socket
CMI (Combined Multiple I/O) Interface	<ul style="list-style-type: none"> 1x Combined Multiple I/O (CMI) Interface
CFM (Control Function Module) Interface	<ul style="list-style-type: none"> 1x Control Function Module (CFM) Interface
Universal I/O Bracket	<ul style="list-style-type: none"> 1x Universal I/O Bracket
Antenna Hole	<ul style="list-style-type: none"> 2x Antenna Holes
Other Function	
WatchDog Timer	<ul style="list-style-type: none"> Software Programmable Supports 256 Levels System Reset

Power Requirement	
Power Type	• AT / ATX
Power Supply Voltage	• 9~48VDC
Connector	• 1x 3-pin Terminal Block
Power Adaptor	• Power Adapter AC/DC 12V/5A 60W or 24V/5A 120W (Optional)
Physical	
Dimensions (W x D x H)	• 150 x 105 x 52.3 mm
Weight	• 0.87 kg
Construction	• Extruded Aluminum with Heavy Duty Metal
Mounting	• Wall / VESA (Optional DIN-Rail/Side Mounting)
Physical Design	<ul style="list-style-type: none"> • Unibody Chassis • Fanless Design • Jumper-less Design • Cable-less Design
Protection	
Reverse Power Input Protection	• Yes
Over Voltage Protection	<ul style="list-style-type: none"> • Protection Range: 51~58V • Protection Type: shut down operating voltage, re-power on at the preset level to recover
Over Current Protection	• 20A
Operating System	
Windows	• Windows® 10
Linux	• Supports by project
Environment	
Operating Temperature	<ul style="list-style-type: none"> • -40°C to 70°C * With extended temperature peripherals; Ambient with air flow * According to IEC60068-2-1, IEC60068-2-2, IEC60068-2-14
Storage Temperature	• -40°C to 85°C
Relative Humidity	• 95%RH @ 70°C (non-Condensing)
Shock	<ul style="list-style-type: none"> • Operating, 50 Grms, Half-sine 11 ms Duration * w/ SSD, according to IEC60068-2-27
Vibration	<ul style="list-style-type: none"> • Operating, 5 Grms, 5-500 Hz, 3 Axes * w/ SSD, according to IEC60068-2-64
MTBF	• 632,353 Hours
EMC	• CE, UKCA, FCC, ICES-003 Class A
EMI	<ul style="list-style-type: none"> • CISPR 32 Conducted & Radiated: Class A • EN/BS EN 55032 Conducted & Radiated: Class A • EN/BS EN IEC 61000-3-2 Harmonic current emissions: Class A • EN/BS EN61000-3-3 Voltage fluctuations & flicker • FCC 47 CFR Part 15B, ICES-003 Conducted & Radiated: Class A
EMS	<ul style="list-style-type: none"> • EN/IEC 61000-4-2 ESD: Contact: 4 kV; Air: 8 kV • EN/IEC 61000-4-3 RS: 80 MHz to 1000 MHz: 3 V/m • EN/IEC 61000-4-4 EFT: AC Power: 1 kV; DC Power: 0.5 kV; Signal: 0.5 kV • EN/IEC 61000-4-5 Surges: AC Power: 2 kV; Signal: 1 kV • EN/IEC 61000-4-6 CS: 3V • EN/IEC 61000-4-8 PFMF: 50 Hz, 1A/m • EN/IEC 61000-4-11 Voltage Dips & Voltage Interruptions: 0.5 cycles at 50 Hz
Safety	• Safety: UL, cUL, CB, IEC/EN62368-1

External Layout

Front I/O

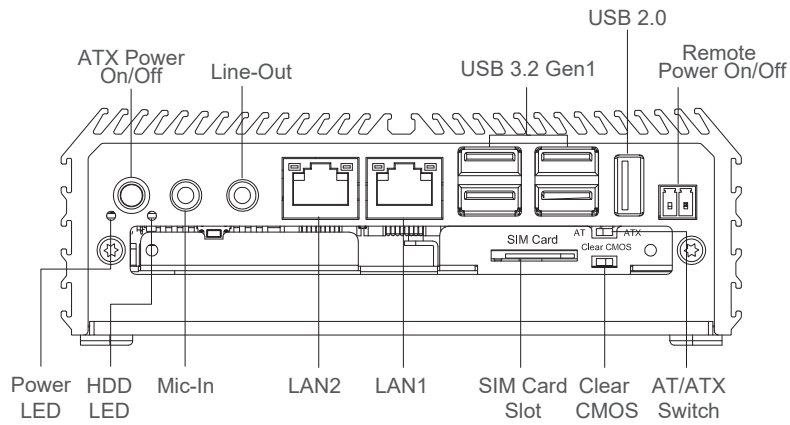

Rear I/O

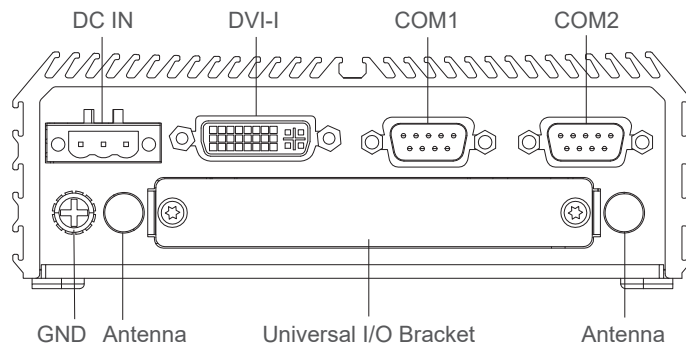

Dimensions

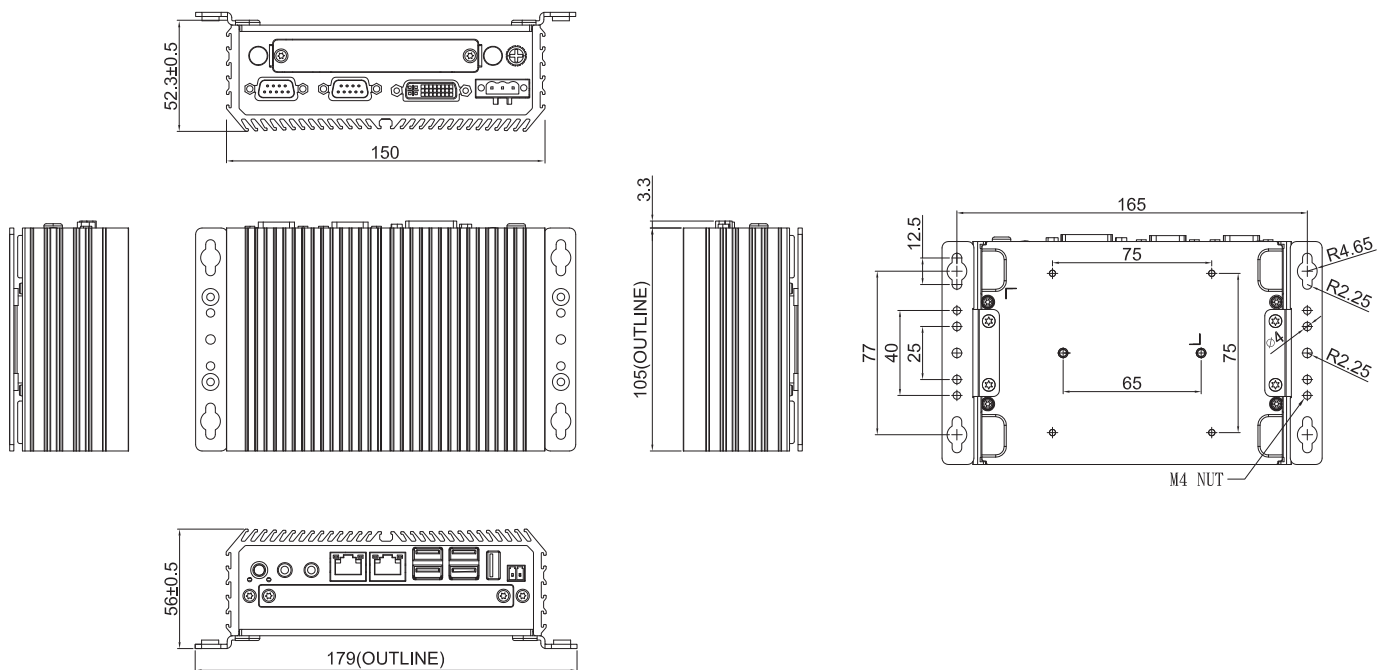

Unit: mm

Ordering Information

Available Models







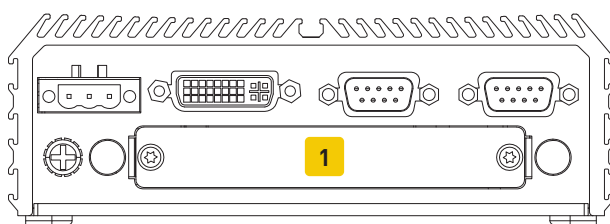

Model No.	Description
DA-1100-N42-R10	Intel® Pentium® Processor N4200 Affordable Fanless Embedded Computer
DA-1100-N33-R10	Intel® Celeron® Processor N3350 Affordable Fanless Embedded Computer

Package Checklist

• DA-1100 Affordable Fanless Embedded Computer	• DVI-I to VGA Adapter x 1
• Thermal Pad (for CPU Thermal Block) x 1	• Screw Pack x 1
• Power Terminal Block Connector x 1	• Wall Mounting Kit x 1
• Remote Power On/Off Terminal Block Connector x 1	

Optional I/O Modules



Model No.	Description	1
 CMI-COM102/UB0403	CMI Module with 2x RS232/422/485, 1x Universal Bracket (96 x 15 mm)	V
 CMI-DIO100/UB0415	CMI Module with 8x Optical Isolated DIO (4 in/4 out), 1x Universal Bracket (96 x 15 mm)	V
 CMI-DP101/UB0406	CMI Module with 1x Display Port, 1x Universal Bracket (96 x 15 mm)	V
 CMI-DVI101/UB0407	CMI Module with 1x DVI-D Connector, 1x Universal Bracket (96 x 15 mm)	V
 CMI-LPPS102/UB0409	CMI Module with 1x LPT Port, 1x PS/2, 1x Universal Bracket (96 x 15 mm)	V
 CMI-VGA101/UB0416	CMI Module with 1x VGA Port, 1x Universal Bracket (96 x 15 mm)	V
 CMI-HD01/UB0408	CMI Module with 1x HDMI Port for DA Series, 1x Universal Bracket with HDMI Cutout for DA Series	V
 MEC-LAN-M102-15/UB0411	Mini-PCie Module with 2x LAN Ports, 1x Universal Bracket (96 x 15 mm) * Only can be compatible with half slim SSD and mSATA when MEC-LAN is installed.	V

Optional Function Modules

Model No.	Description
CFM-PoE02	CFM Module with PoE Control Function, Individual Port 25.5W

Optional Function Modules

Model No.	Description
SIDE02	Side Mount Kit for DA Series, with KMRH-K175 for DIN-Rail option
DINRAIL-R10	Diamond series DIN-RAIL Mount Kit
GST60A12-CIN1	Adapter AC/DC 12V 5A 60W, with 3pin Terminal Block Plug 5.0mm Pitch with Tubes, Level VI
GST120A24-CIN	Adapter AC/DC 24V 5A 120W, GST120A24-CIN, wide temp (-30°C ~ +70°C), level VI