

cincoze

DE-1000 Series

User Manual



Power Efficient Fanless Computers
DE-1000



Power Efficient Fanless Computers
DE-1001



Power Efficient Fanless Computers
DE-1002

Contents

Preface

Revision.....	05
Copyright Notice.....	05
Acknowledgement.....	05
Disclaimer.....	05
Declaration of Conformity.....	06
Product Warranty Statement	06
Technical Support and Assistance.....	07
Conventions Used in this Manual	08
Safety Precaution	08
Package Contents	09
Ordering Information	10

Chapter 1 Product Introductions

1.1 Overview	12
1.2 Product Pictures.....	12
1.3 Key Features.....	13
1.4 Hardware Specification.....	14
1.5 System I/O.....	15
1.6 Mechanical Dimension.....	21

Chapter 2 Jumpers, Switches and Connectors

2.1 Jumpers Settings	25
2.2 Location of the Jumpers/Switches/Connectors.....	25
2.2.1 Top View	25
2.2.2 Bottom View	26
2.3 Definition of Jumpers/Switches/Connectors.....	27
2.4 Definition of Jumpers.....	28
2.5 Definition of Switches.....	29
2.6 Definition of Connectors	31

Chapter 3 System Setup

3.1 Remove the Chassis Bottom Cover.....	41
3.2 Removing the Chassis.....	42
3.3 Installing a Half Size Mini PCIe Card on Upper Side.....	43
3.4 Installing a Full Size Mini PCIe Card on Upper Side.....	45
3.5 Installing Antenna.....	47

3.6	Installing a SATA Hard Drive on Upper Side.....	49
3.7	Installing a SATA Hard Drive on Bottom Side.....	51
3.8	Installing SO-DIMM 1.....	52
3.9	Installing SO-DIMM 2.....	54
3.10	Installing Half Size Mini PCIe Card on Bottom Side.....	57
3.11	Installing Full Size Mini PCIe Cards on Bottom Side.....	59
3.12	Installing the PCI/PCIe Cards on Expansion Module (DE-1001 and DE-1002 Only).....	62
3.13	Installing the Chassis.....	65
3.14	Installing the Chassis Bottom Cover.....	66
3.15	Installing a SIM Card.....	67
3.16	Installing a CFast Card.....	68
3.17	Wall Mount Bracket.....	69

Chapter 4 BIOS Setup

4.1	BIOS Introduction	72
4.2	Main Setup	73
4.2.1	System Date	73
4.2.2	System Time	73
4.3	Advanced Setup	74
4.3.1	ACPI Setting	74
4.3.2	Super IO Configuration.....	75
4.3.3	Hardware Monitor.....	76
4.3.4	Serial Port Console Redirection.....	77
4.3.5	CPU Configuration.....	77
4.3.6	PPM Configuration.....	78
4.3.7	Thermal Configuration.....	79
4.3.8	IDE Configuration.....	80
4.3.9	OS Selection.....	80
4.3.10	CSM (Compatibility Support Module) Configuration.....	81
4.3.11	USB Configuration.....	82
4.4	Chipset Setup	83
4.4.1	North Bridge.....	83
4.4.2	South Bridge.....	85
4.5	Security Setup	87
4.5.1	Administrator Password	87
4.5.2	User Password	87
4.6	Boot Setup	88
4.6.1	Setup Prompt Timeout.....	88
4.6.2	Bootup NumLock State.....	88

4.6.3 Full Screen Logo Show.....	88
4.6.4 Fast Boot	88
4.7 Save & Exit	89
4.7.1 Save Changes and Reset	89
4.7.2 Discard Changes and Reset	89
4.7.3 Restore Defaults	89
4.7.4 Save as User Defaults	89
4.7.5 Restore User Defaults	89

Chapter 5 Product Application

5.1 Digital I/O (DIO) application	91
5.1.1 Digital I/O Programming Guide	91
5.2 DE-1000 Digital I/O (DIO) Hardware Specification	97

Preface

Revision

Revision	Description	Date
1.00	First Release	2015/01/12
1.10	DIO PIN Define Revision	2015/05/08
1.20	Content corrected, product pictures updated, CH. 5 added	2016/06/20
1.30	Add 1.2 support dimension of add-on card	2017/06/21
1.40	Correction Made	2018/11/20
1.41	Correction Made	2020/04/09
1.42	New Format Updated	2020/10/22
1.43	LVD Number Updated	2021/02/08
1.44	Add DC_IN1 Warning	2021/04/20
1.45	Correction Made	2021/06/28
1.46	Correction Made	2022/05/31
1.47	Correction Made	2023/04/14

Copyright Notice

© 2014 by Cincoze Co., Ltd. All rights are reserved. No parts of this manual may be copied, modified, or reproduced in any form or by any means for commercial use without the prior written permission of Cincoze Co., Ltd. All information and specification provided in this manual are for reference only and remain subject to change without prior notice.

Acknowledgement

Cincoze is a registered trademark of Cincoze Co., Ltd. All registered trademarks and product names mentioned herein are used for identification purposes only and may be trademarks and/or registered trademarks of their respective owners.

Disclaimer

This manual is intended to be used as a practical and informative guide only and is subject to change without notice. It does not represent a commitment on the part of Cincoze. This product might include unintentional technical or typographical errors. Changes are periodically made to the information herein to correct such errors, and these changes are incorporated into new editions of the publication.

Declaration of Conformity



FCC

This equipment has been tested and found to comply with the limits for a Class A digital device, pursuant to Part 15 of the FCC Rules. These limits are designed to provide reasonable protection against harmful interference when the equipment is operated in a commercial environment. This equipment generates, uses, and can radiate radio frequency energy and, if not installed and used in accordance with the instruction manual, may cause harmful interference to radio communications. Operation of this equipment in a residential area is likely to cause harmful interference in which case the user will be required to correct the interference at his own expense.



CE

The product(s) described in this manual complies with all application European Union (CE) directives if it has a CE marking. For computer systems to remain CE compliant, only CE-compliant parts may be used. Maintaining CE compliance also requires proper cable and cabling techniques.

Product Warranty Statement

Warranty

Cincoze products are warranted by Cincoze Co., Ltd. to be free from defect in materials and workmanship for 2 years from the date of purchase by the original purchaser. During the warranty period, we shall, at our option, either repair or replace any product that proves to be defective under normal operation. Defects, malfunctions, or failures of the warranted product caused by damage resulting from natural disasters (such as by lightning, flood, earthquake, etc.), environmental and atmospheric disturbances, other external forces such as power line disturbances, plugging the board in under power, or incorrect cabling, and damage caused by misuse, abuse, and unauthorized alteration or repair, and the product in question is either software, or an expendable item (such as a fuse, battery, etc.), are not warranted.

RMA

Before sending your product in, you will need to fill in Cincoze RMA Request Form and obtain a RMA number from us. Our staff is available at any time to provide you with the most friendly and immediate service.

■ RMA Instruction

- Customers must fill in Cincoze Return Merchandise Authorization (RMA) Request Form and obtain an RMA number prior to returning a defective product to Cincoze for service.

- Customers must collect all the information about the problems encountered and note anything abnormal and describe the problems on the “Cincoze Service Form” for the RMA number apply process.
- Charges may be incurred for certain repairs. Cincoze will charge for repairs to products whose warranty period has expired. Cincoze will also charge for repairs to products if the damage resulted from acts of God, environmental or atmospheric disturbances, or other external forces through misuse, abuse, or unauthorized alteration or repair. If charges will be incurred for a repair, Cincoze lists all charges, and will wait for customer’s approval before performing the repair.
- Customers agree to ensure the product or assume the risk of loss or damage during transit, to prepay shipping charges, and to use the original shipping container or equivalent.
- Customers can be sent back the faulty products with or without accessories (manuals, cable, etc.) and any components from the system. If the components were suspected as part of the problems, please note clearly which components are included. Otherwise, Cincoze is not responsible for the devices/parts.
- Repaired items will be shipped along with a "Repair Report" detailing the findings and actions taken.

Limitation of Liability

Cincoze’ liability arising out of the manufacture, sale, or supplying of the product and its use, whether based on warranty, contract, negligence, product liability, or otherwise, shall not exceed the original selling price of the product. The remedies provided herein are the customer’s sole and exclusive remedies. In no event shall Cincoze be liable for direct, indirect, special or consequential damages whether based on contract of any other legal theory.

Technical Support and Assistance

1. Visit the Cincoze website at www.cincoze.com where you can find the latest information about the product.
2. Contact your distributor or our technical support team or sales representative for technical support if you need additional assistance. Please have following information ready before you call:
 - Product name and serial number
 - Description of your peripheral attachments
 - Description of your software (operating system, version, application software, etc.)
 - A complete description of the problem
 - The exact wording of any error messages

Conventions Used in this Manual



WARNING

This indication alerts operators to an operation that, if not strictly observed, may result in severe injury.



CAUTION

This indication alerts operators to an operation that, if not strictly observed, may result in safety hazards to personnel or damage to equipment.



NOTE

This indication provides additional information to complete a task easily.

Safety Precautions

Before installing and using this device, please note the following precautions.

1. Read these safety instructions carefully.
2. Keep this User's Manual for future reference.
3. Disconnect this equipment from any AC outlet before cleaning.
4. For plug-in equipment, the power outlet socket must be located near the equipment and must be easily accessible.
5. Keep this equipment away from humidity.
6. Put this equipment on a reliable surface during installation. Dropping it or letting it fall may cause damage.
7. Make sure the voltage of the power source is correct before connecting the equipment to the power outlet.
8. Use a power cord that has been approved for using with the product and that it matches the voltage and current marked on the product's electrical range label. The voltage and current rating of the cord must be greater than the voltage and current rating marked on the product.
9. Position the power cord so that people cannot step on it. Do not place anything over the power cord.
10. All cautions and warnings on the equipment should be noted.
11. If the equipment is not used for a long time, disconnect it from the power source to avoid

damage by transient overvoltage.

12. Never pour any liquid into an opening. This may cause fire or electrical shock.
13. Never open the equipment. For safety reasons, the equipment should be opened only by qualified service personnel.

If one of the following situations arises, get the equipment checked by service personnel:

- The power cord or plug is damaged.
 - Liquid has penetrated into the equipment.
 - The equipment has been exposed to moisture.
 - The equipment does not work well, or you cannot get it work according to the user's manual.
 - The equipment has been dropped and damaged.
 - The equipment has obvious signs of breakage.
14. CAUTION: Danger of explosion if battery is incorrectly replaced. Replace only with the same or equivalent type recommended by the manufacturer.
 15. Equipment intended only for use in a RESTRICTED ACCESS AREA.

Package Contents



Before installation, please ensure all the items listed in the following table are included in the package.

Item	Description	Q'ty
1	DE-1000 / DE-1001 / DE-1002 Embedded System	1
2	DIO Terminal Block Connector	2
3	Power Terminal Block Connector	1
4	Remote Power Terminal Block Connector	2
5	DVI-I to VGA Adaptor	1
6	Screws Pack	1
7	Wall Mount Kit	1

Note: Notify your sales representative if any of the above items are missing or damaged.

Ordering Information

Model No.	Product Description
DE-1000	Intel Atom E3845 Quad Core Power Efficient Fanless Computer
DE-1001-E	Intel Atom E3845 Quad Core Power Efficient Fanless Computer with 1x PCIe1 Expansion
DE-1001-P	Intel Atom E3845 Quad Core Power Efficient Fanless Computer with 1x PCI Expansion
DE-1002-EE	Intel Atom E3845 Quad Core Power Efficient Fanless Computer with 2x PCIe1 Expansions
DE-1002-PP	Intel Atom E3845 Quad Core Power Efficient Fanless Computer with 2x PCI Expansions



Chapter 1

Product Introductions

1.1 Overview



DE-1000 Series Fanless Embedded PC supports Intel® Bay Trail platform, integrated with Intel® Atom™ E3845 Quad Core 1.91 GHz processor. Delivering the excellent quad-core processing power at only 10 watts power consumption, DE-1000 series is definitely an ideal solution for ultimate computing performance, energy efficiency, and superior reliability.

Designed with rich I/O, high flexibility and easy expansion capabilities, DE-1000 series is ideal for diverse industrial applications. It offers multiple I/O extension modules, including up to 2x PCI or 2x PCIe x1 slot for flexible integration of a variety of add-on cards; 2x mini-PCIe slot for GSM and WLAN wireless communication; it also supports three storage expansions: 2.5" SATA HDD, CFast and SIM card.

Supporting up to 6x LAN or 4x PoE versions, and power ignition function, DE-1000 series can meet various applications, such as: surveillance, in-vehicle, and industrial automation applications, etc.

DE-1000 series supports wide temperature range from -25°C to +70°C, wide range 9-48VDC power input, power protection, cable-less and one-piece housing design, as well as compliant with EN50155 certification for rail transportation applications; it is designed to ensure stable operation in robust and harsh environments.

1.2 Product pictures

DE-1000	DE-1001	DE-1002
		
Front		
		
Rear		

1.3 Key Features

- Onboard Intel® Atom™ E3845 Processor Quad Core, 1.91GHz
- 2x DDR3L SO-DIMM Max. up to 8GB
- Dual Independent Display from 1x DVI-I and 1x DisplayPort
- 2x Intel® GbE Port, Support Wake-on-LAN and PXE (DE-1000, DE-1001, DE-1002 Only)
- 1x USB 3.0, 4x USB 2.0
- 6x RS232/422/485 Port with 5V/12V Power
- 4x Isolated DI, 4x Isolated DO
- 2x 2.5" SATA SSD/HDD Bay, 1x mSATA (Shared by Mini-PCIe Socket) , 1x CFast Card and 1x SIM Card Socket
- 9-48VDC Power Input, support AT/ATX Mode
- 2x Mini-PCIe Slot for Wi-Fi, GSM, or I/O Expansion
- 1x PCI or 1x PCIe x1 Expansion (DE-1001)
- 2x PCI or 2x PCIe x1 Expansion (DE-1002)
- Power Ignition
- EN50155 (EN50121-3-2) / EN62368-1 Certified

1.4 Hardware Specification

Processor

- Onboard Intel® Atom™ Processor E3845 Quad Core, 1.91 GHz with AMI 64Mbit SPI BIOS

Memory

- 2x 204-Pin DDR3L-1066 / 1333MHz SO-DIMM (un-buffered and non-ECC), Max. up to 8GB

Display

Dual Display

- 1x DVI and 1x DisplayPort
- 1x DVI-D and 1x VGA (w/ Optional Split Cable)
- 1x DisplayPort and 1x VGA (w/ DVI-I to VGA Adapter)

Ethernet

- 2x Intel® I210 GbE LAN Port, Support Wake-on-LAN and PXE

Audio Codec

- Codec: Realtek ALC888S
- 1x Mic-in and 1x Line-out

Watchdog Timer

- Software Programmable Supports 256 Levels System Reset

Storage

- 2x 2.5" SATA HDD Bay
- 1x Internal mSATA Slot (Shared by Mini-PCIe Socket)
- 1x External CFast Socket
- 1x External SIM Card Socket

I/O Interface

- 1x USB 3.0 Port
- 4x USB 2.0 Port
- 8x Optical Isolated DIO (4xDI, 4xDO), 10 Pin Terminal Block Support 9-30V
- 6x DB9 for COM1~6, Support RS-232/422/485 with Auto Flow Control
- 1x PS/2 Port
- 2x Antenna Hole
- 1x Power Switch
- 1x AT/ATX Switch
- 1x Remote Power and Reset Connector

Power Requirement

- Support AT, ATX Mode
- 1x 3-pin Terminal Block Connector with Power Input 9-48VDC
- 1x Optional AC/DC 12V/5A, 60W Power Adapter
- 1x Optional AC/DC 24V/5A, 120W Power Adapter

Expansion

- **DE-1001-E:**
 - ✓ 1x PCIe x1
 - Support maximum dimension of add-on card (H x L): 111.15mm x 174.63mm
- **DE-1001-P:**
 - ✓ 1x PCI
 - Support maximum dimension of add-on card (H x L): 111.15mm x 174.63mm

- **DE-1002-EE:**

- ✓ 2x PCIe x1
- Support maximum dimension of add-on card (H x L): 111.15mm x 174.63mm

- **DE-1002-PP:**

- ✓ 2x PCI
- Support maximum dimension of add-on card (H x L): 111.15mm x 174.63mm
- 2x Full-size Mini PCIe Socket for Wi-Fi / GSM / Expansion Module
- 1x Universal I/O Bracket (DE-1001)
- 2x Universal I/O Bracket (DE-1002)

Physical

- **DE-1000**

- Dimension (WxDxH): 203 x 200 x 65 mm
- Weight: 2.84 kg

- **DE-1001**

- Dimension (WxDxH): 203 x 200 x 96.5 mm
- Weight: 3.42 kg

- **DE-1002**

- Dimension (WxDxH): 203 x 200 x 114.5 mm
- Weight: 3.76 kg
- Construction: Extruded Aluminum with Heavy Duty Metal
- Mounting: Wall Mounting (Side / VESA / DIN-Rail)

Protection

- Reverse Power Input Protection
- Over Voltage Protection
 - Protection Range: 51-58V
 - Protection Type: shut down operating voltage, re-power on at the present level to recover
- Over Current Protection: 15A
- ESD Protection: +/-8kV (air), +/-4kV (contact)
- Surge Protection: 2 kV

Operating System

- Windows® 10/ 8/ Embedded 8 Standard/ 7/ Embedded Standard 7
- Linux®: Supports by project

Environment

- Operating Temperature: Ambient with Air Flow: -25°C to 70°C (with Industrial Grade Peripherals)
- Storage Temperature: -30°C to 85°C
- Relative humidity: 10%~95% (non-condensing)
- Shock: 50 Grms (According to IEC 60068-2-27, Half Sine, 11ms Duration)
- Vibration: Random: 5 Grms (According to IEC 60068-2-64, 5~500Hz, 1hr/axis)

Certification

- CE
- FCC Class A
- EN 50155
- EN 50121-3-2
- LVD EN62368-1

1.5 System I/O

1.5.1 DE-1000

Front Panel

ATX Power On/Off

Used to power-on or power-off the system

Power LED

Indicates the power status of the system

HDD LED

Indicates the status of the hard drive

USB2.0

Used to connect to USB 2.0/1.1 compatible devices

AT/ATX Mode Select Switch

Used to select AT or ATX power mode

CFast and SIM Card Slot

Used to insert a CFast card and a SIM card

COM Port

Used to connect to RS-232/422/485 serial devices

Digital I/O Terminal Block

The Digital I/O terminal block supports 8 isolated DIO (4 digital input and 4 digital output)

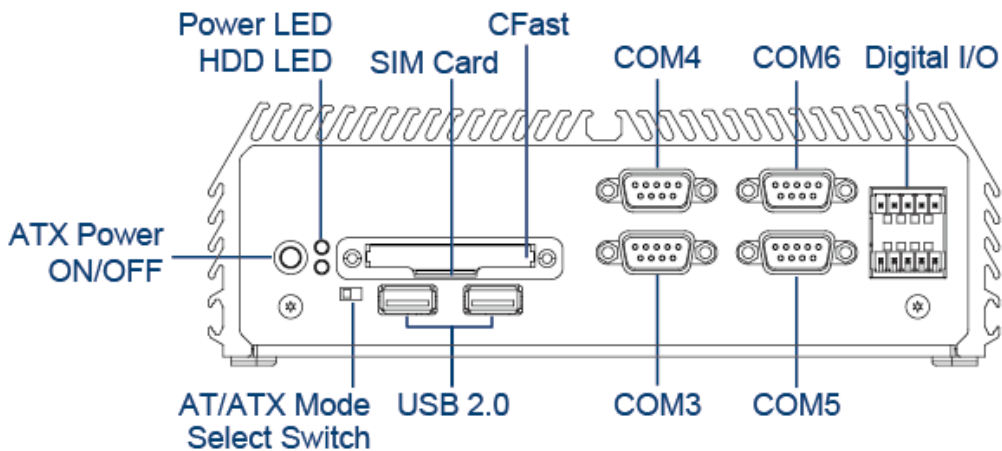

Rear Panel

DC IN

Used to plug a DC power input with terminal block

DVI-I Port

Used to connect a DVI monitor or connect optional split cable for dual display mode

PS/2 Port

Used to connect the PS/2 device

LAN Port (1~2)

Used to connect to local area network

USB3.0

Used to connect to USB 3.0/2.0/1.1 compatible devices

USB2.0

Used to connect to USB 2.0/1.1 compatible devices

Display Port

Used to connect a monitor with DisplayPort interface

Antenna Hole

Used to connect an antenna for optional wireless module

COM Port

Used to connect to RS-232/422/485 serial devices

Mic-In

Used to connect a microphone

Line-Out

Used to connect a speaker

Remote Power On/Off and Remote Power Reset Terminal Block

A terminal block used to connect to a remote power on/off switch and a remote power reset switch

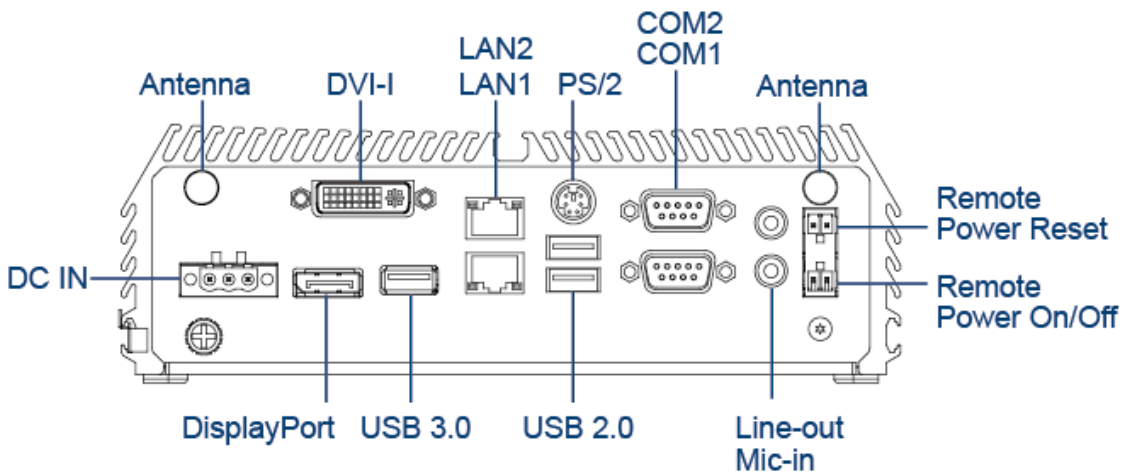

1.5.2 DE-1001

Front Panel

ATX Power On/Off

Used to power-on or power-off the system

Power LED

Indicates the power status of the system

HDD LED

Indicates the status of the hard drive

USB2.0

Used to connect to USB 2.0/1.1 compatible devices

AT/ATX Mode Select Switch

Used to select AT or ATX power mode

CFast and SIM Card Slot

Used to insert a CFast card and a SIM card

COM Port

Used to connect to RS-232/422/485 serial devices

Digital I/O Terminal Block

The Digital I/O terminal block supports 8 isolated DIO (4 digital input and 4 digital output)

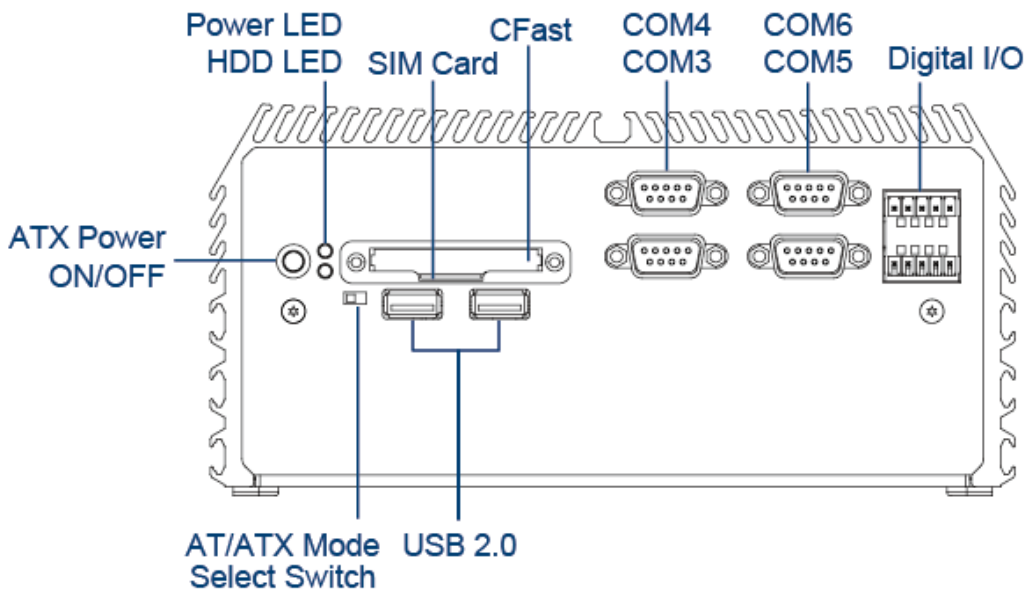

Rear Panel

DC IN

Used to plug a DC power input with terminal block

DVI-I Port

Used to connect a DVI monitor or connect optional split cable for dual display mode

PS/2 Port

Used to connect the PS/2 device

LAN Port (1~2)

Used to connect to local area network

USB3.0

Used to connect to USB 3.0/2.0/1.1 compatible devices

USB2.0

Used to connect to USB 2.0/1.1 compatible devices

Display Port

Used to connect a monitor with DisplayPort interface

Antenna Hole

Used to connect an antenna for optional wireless module

COM Port

Used to connect to RS-232/422/485 serial devices

Mic-In

Used to connect a microphone

Line-Out

Used to connect a speaker

Remote Power On/Off and Remote Power Reset Terminal Block

A terminal block used to connect to a remote power on/off switch and a remote power reset switch

Universal I/O Bracket

Used to customized I/O output with optional modules

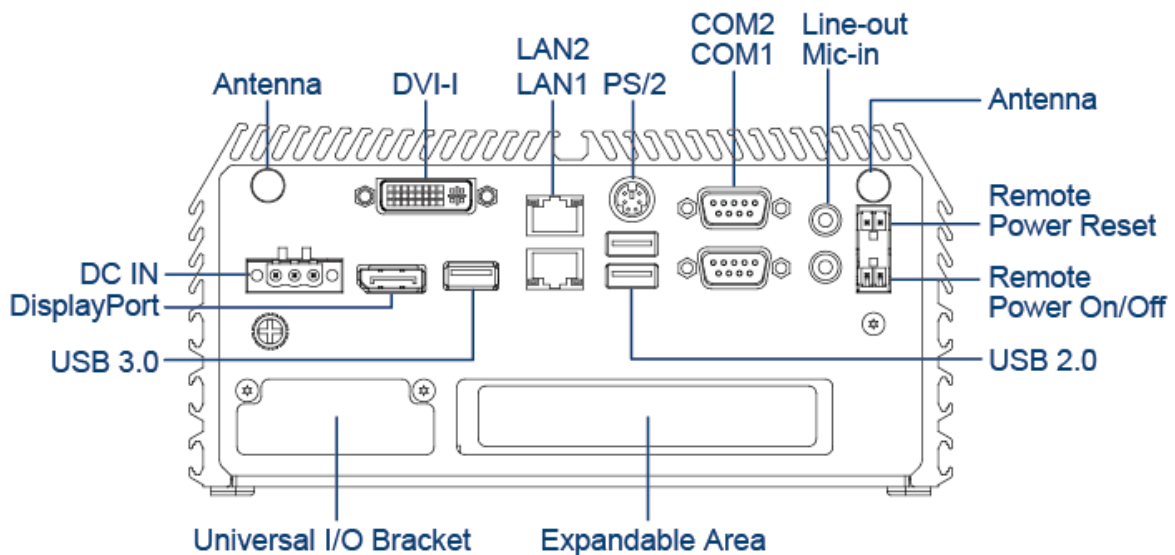

1.5.3 DE-1002

Front Panel

ATX Power On/Off

Used to power-on or power-off the system

Power LED

Indicates the power status of the system

HDD LED

Indicates the status of the hard drive

USB2.0

Used to connect to USB 2.0/1.1 compatible devices

AT/ATX Mode Select Switch

Used to select AT or ATX power mode

CFast and SIM Card Slot

Used to insert a CFast card and a SIM card

COM Port

Used to connect to RS-232/422/485 serial devices

Digital I/O Terminal Block

The Digital I/O terminal block supports 8 isolated DIO (4 digital input and 4 digital output)

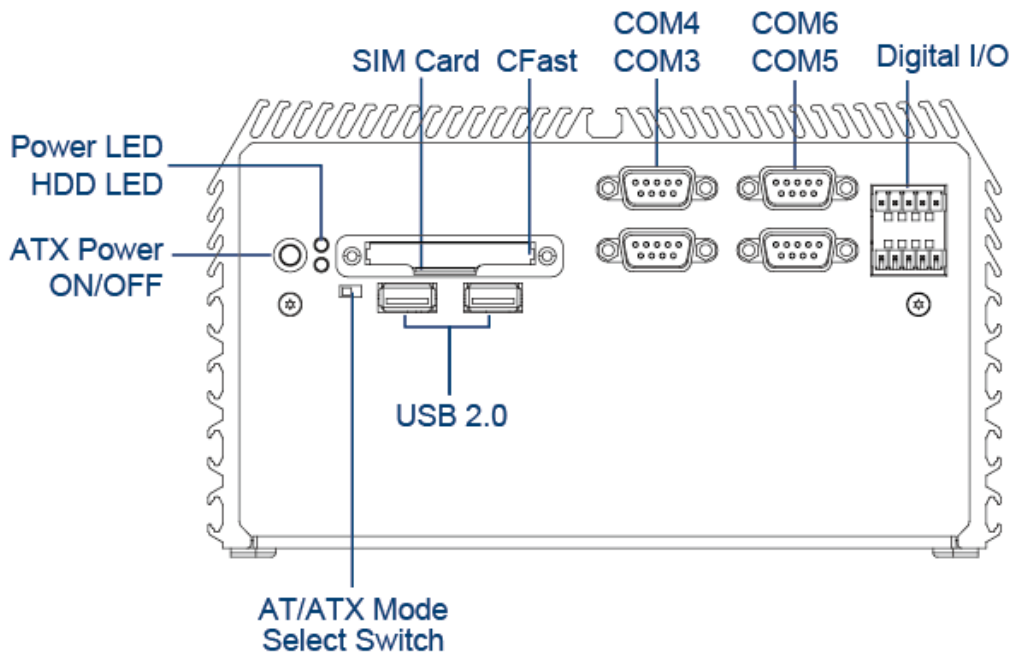

Rear Panel

DC IN

Used to plug a DC power input with terminal block

DVI-I Port

Used to connect a DVI monitor or connect optional split cable for dual display mode

PS/2 Port

Used to connect the PS/2 device

LAN Port (1~2)

Used to connect to local area network

USB3.0

Used to connect to USB 3.0/2.0/1.1 compatible devices

USB2.0

Used to connect to USB 2.0/1.1 compatible devices

Display Port

Used to connect a monitor with DisplayPort interface

Antenna Hole

Used to connect an antenna for optional wireless module

COM Port

Used to connect to RS-232/422/485 serial devices

Mic-In

Used to connect a microphone

Line-Out

Used to connect a speaker

Remote Power On/Off and Remote Power Reset Terminal Block

A terminal block used to connect to a remote power on/off switch and a remote power reset switch

Universal I/O Bracket

Used to customized I/O output with optional modules

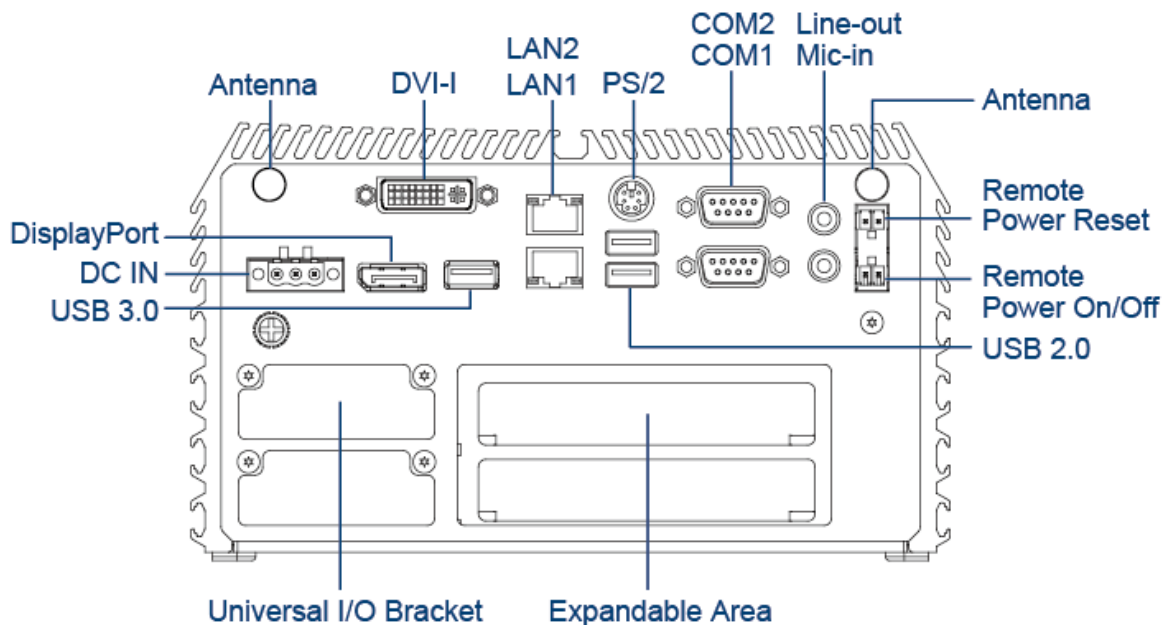

1.6 Mechanical Dimension

1.6.1 DE-1000

Unit: mm

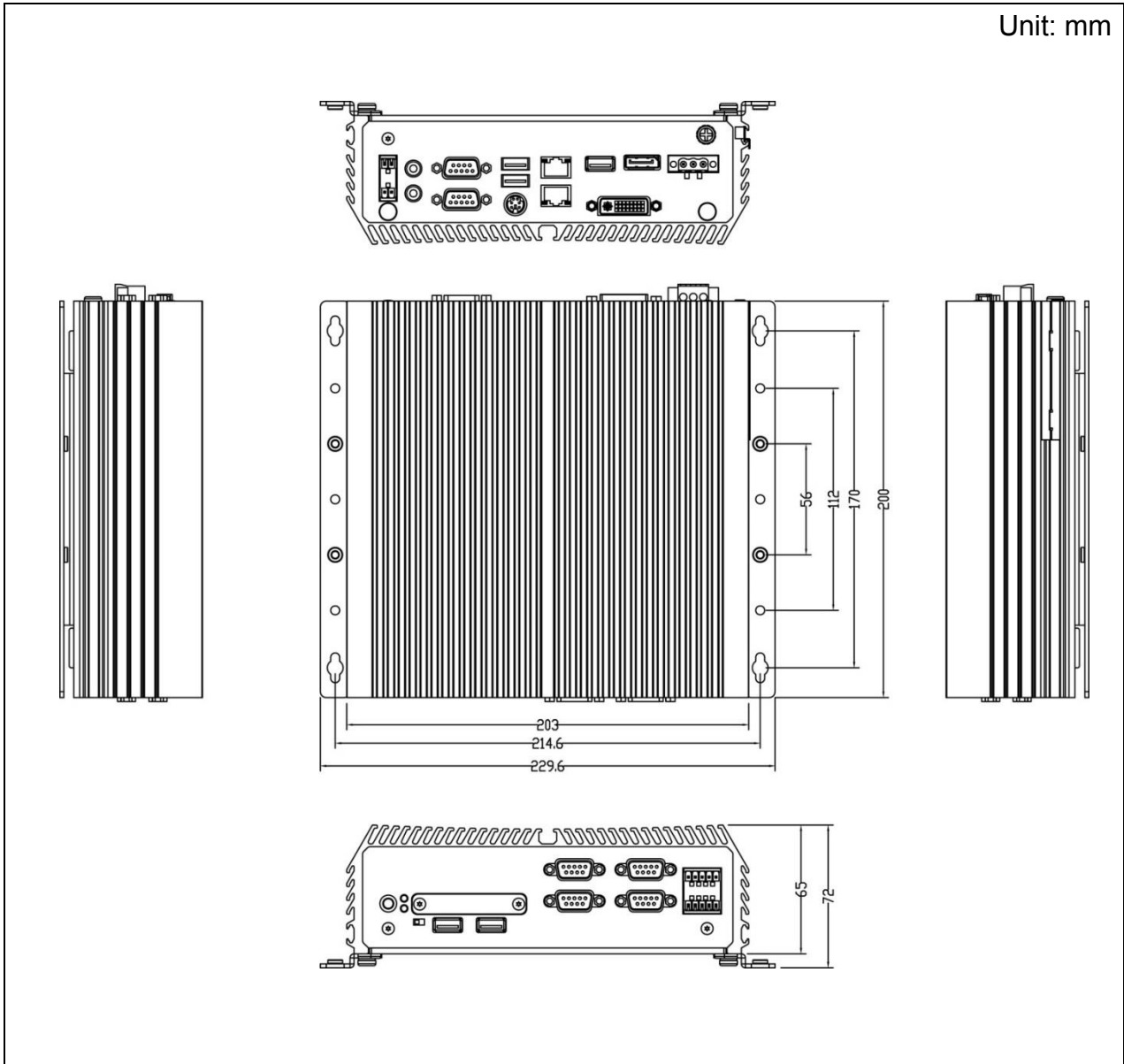

1.6.2 DE-1001

Unit: mm

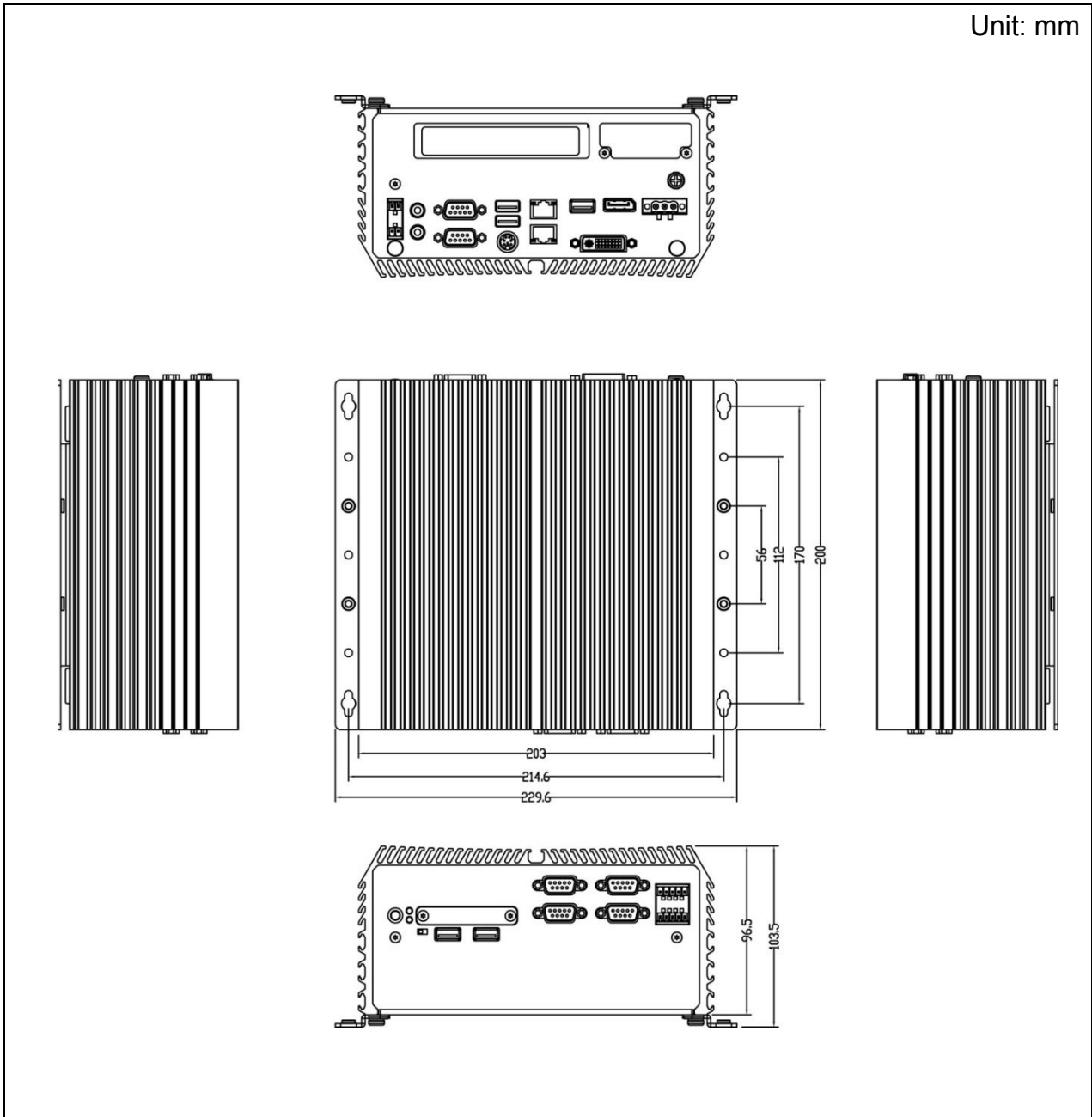

1.6.3 DE-1002

Unit: mm

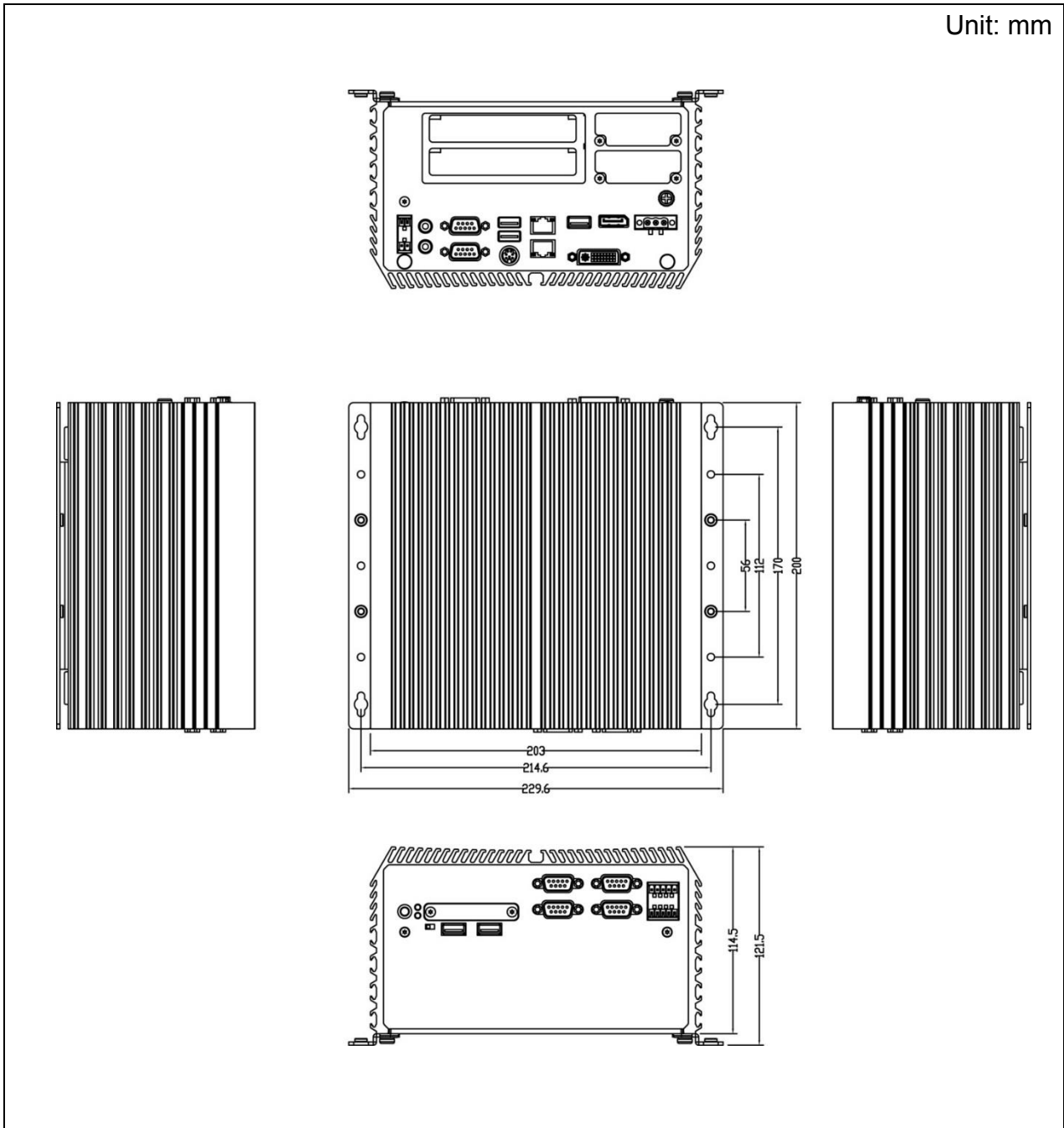



Chapter 2

Jumpers, Switches & Connectors

2.1 Jumpers Settings

When setting the jumpers, ensure that the jumper caps are placed on the correct pins. When the jumper cap is placed on both pins, the jumper is **short**. If you remove the jumper cap, or place the jumper cap on just one pin, the jumper is **open**. Refer to below for examples of the 2-pin and 3-pin jumpers when they are short (on) and open (off).

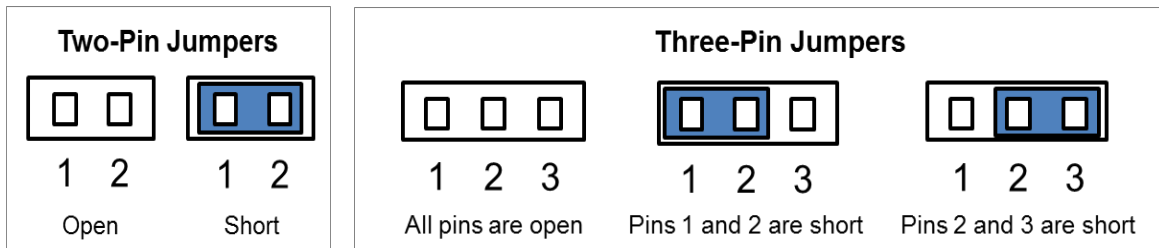

2.2 Location of the Jumpers/Switches/Connectors

2.2.1 Top View

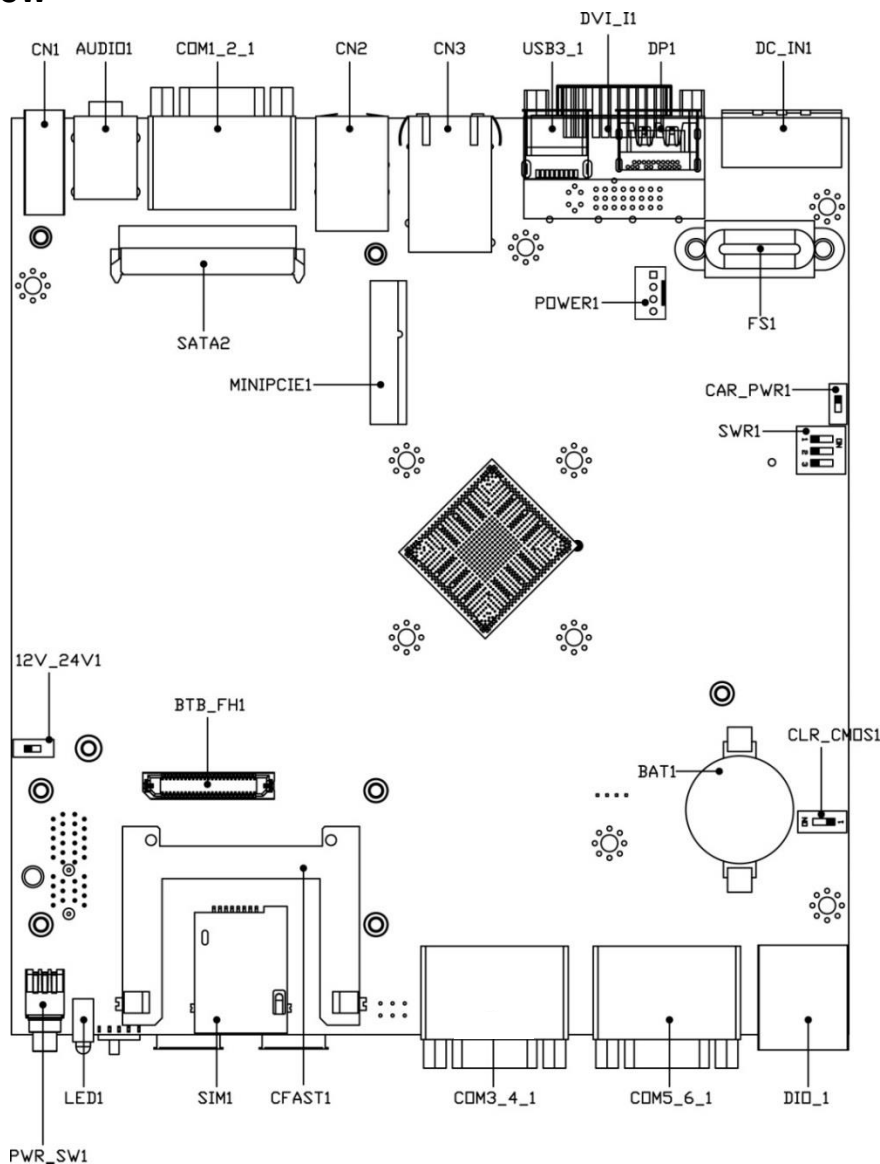

2.2.2 Bottom View

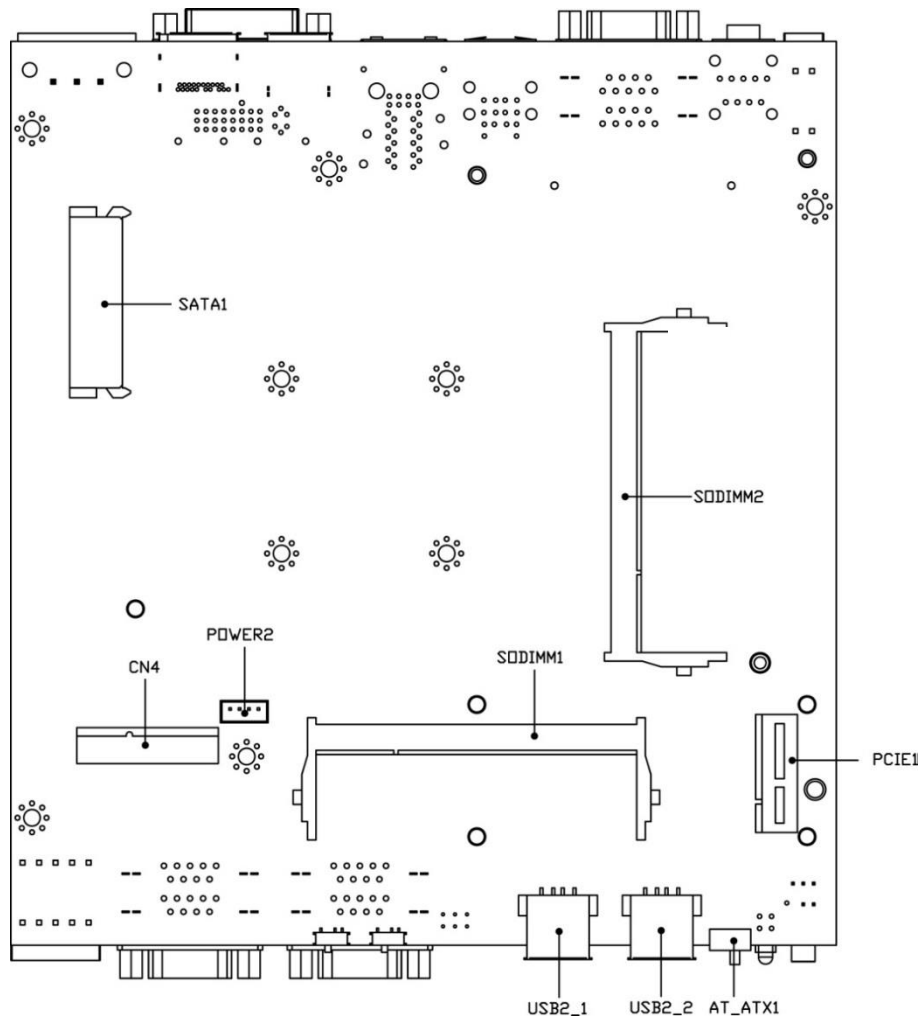

2.3 Definition of Jumpers/Switches/Connectors

List of Jumpers/Switches/Connectors

Location	Definition
12V_24V_1	12V / 24V Car Battery Switch
AT_ATX1	AT / ATX Power Mode Switch
AUDIO1	Audio Jack
CAR_PWR1	Car Power Enable / Disable Switch
CFAST1	CFast Connector
CLR_CMOS1	Clear CMOS Switch
CN1	Remote Power on / off and Remote Reset Switch
CN2	PS/2 and USB2.0 Ports
CN3	LAN1 and LAN2 Ports
CN4	Mini PCI-Express / mSATA Socket
COM1_2_1, COM3_4_1, COM5_6_1	RS232 / RS422 / RS485 Connector
COM12_SEL1, COM34_SEL1, COM56_SEL1	COM1 / COM2 / COM3 / COM4 / COM5 / COM6 with Power Select
DC_IN1	3-pin DC 9-48V Power Input with Power Ignition Connector
DIO1	4DI / 4DO Connector
DP1	DisplayPort Connector
DVI_I1	DVI-I Connector
LED1	System LED Connector
MINIPCIE1	Mini PCI-Express Socket
PCIE1	PCI-Express X1 Socket
POWER1	Power Connector
POWER2	Power Connector
PWR_SW1	Power Switch
SATA1, SATA2	SATA with Power Connector
SIM1	SIM Card Socket
SW1	System Power off Timing Setting
USB2_1, USB2_2	USB 2.0 Ports
USB3_1	USB 3.0 Port

2.4 Definition of Jumpers

COM12_SEL1: COM1 / COM2 with Power Select

Connector Type: 2X5 10-pin Header, 2.54mm pitch

COM1		COM2	
Pin	Definition	Pin	Definition
1-3 On	+5V	2-4 On	+5V
3-5 On	+12V	4-6 On	+12V
7-9 On (Default)	Reserved	8-10 On (Default)	Reserved

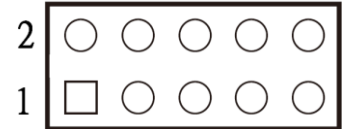

COM34_SEL1: COM3 / COM4 with Power Select

Connector Type: 2X5 10-pin Header, 2.54mm pitch

COM3		COM4	
Pin	Definition	Pin	Definition
1-3 On	+5V	2-4 On	+5V
3-5 On	+12V	4-6 On	+12V
7-9 On (Default)	Reserved	8-10 On (Default)	Reserved

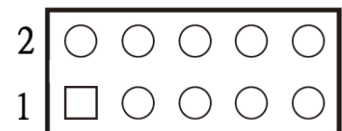

COM56_SEL1: COM5 / COM6 with Power Select

Connector Type: 2X5 10-pin Header, 2.54mm pitch

COM5		COM6	
Pin	Definition	Pin	Definition
1-3 On	+5V	2-4 On	+5V
3-5 On	+12V	4-6 On	+12V
7-9 On (Default)	Reserved	8-10 On (Default)	Reserved

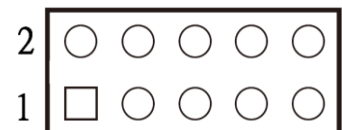

2.5 Definition of Switches

AT_ATX1: AT / ATX Power Mode Switch (based on bottom view)

Pin	Definition
1-2 (Left)	AT Power Mode
2-3 (Right)	ATX Power Mode (Default)



CLR_CMOS1: Clear CMOS Switch (based on top view)

Pin	Definition
1-2 (Right)	Normal Status (Default)
2-3 (Left)	Clear CMOS

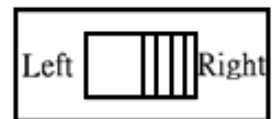

CN1: Remote Power on / off and Remote Reset Switch

Pin	Definition
1	PWR_SW
2	RESET_SW
3	GND
4	GND

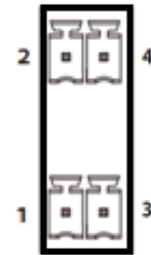

WARNING

**Do not apply power to this connector!
This port is used to connect a SWITCH!**

CAR_PWR1: Car Power Enable / Disable Switch

(based on top view of section 2.2.1)

Pin	Definition
1-2	Car Power Disable (Default)
2-3	Car Power Enable

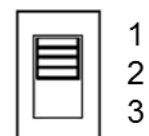

12V_24V_1: 12V / 24V Car Battery Switch (based on top view)

Pin	Definition
1-2	12V Car Battery Input (Default)
2-3	24V Car Battery Input

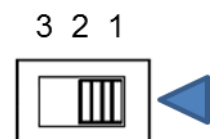

SW1: Set shutdown delay timer when ACC is turned off

Pin 1	Pin 2	Pin 3	Definition
OFF	OFF	OFF	0 second (Default)
ON	ON	OFF	1 minute
ON	OFF	ON	5 minutes
ON	OFF	OFF	10 minutes
OFF	ON	ON	30 minutes
OFF	ON	OFF	1 hour
OFF	OFF	ON	2 hours
ON	ON	ON	Reserved

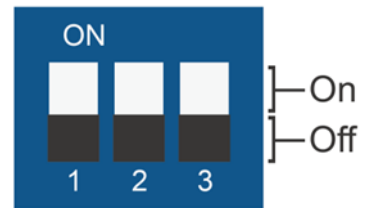

When ignition (IGN or ACC) is turned on, the system will power on in 10 seconds. When the system has shut down with IGN switched off and the shutdown delay timer, it needs at least 60 seconds to be able to start ignition again.

PWR_SW1: Power Switch

Pin	Definition
1	NC
2	Power Button
3	NC
4	GND
5	NC
6	GND



2.6 Definition of Connectors

CFAST1: CFast Connector

Pin	Definition	Pin	Definition	Pin	Definition
S1	GND	PC1	NC	PC10	NC
S2	TX+	PC2	GND	PC11	NC
S3	TX-	PC3	NC	PC12	NC
S4	GND	PC4	NC	PC13	+3.3V
S5	RX-	PC5	NC	PC14	+3.3V
S6	RX+	PC6	NC	PC15	GND
S7	GND	PC7	GND	PC16	GND
		PC8	NC	PC17	NC
		PC9	NC		

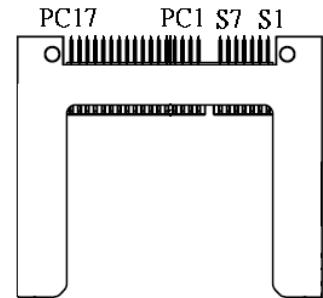

COM1~COM6: RS232 / RS422 / RS485 Connector

Connector Type: 9-pin D-Sub

Pin	RS232 Definition	RS422 / 485 Full Duplex Definition	RS485 Half Duplex Definition
1	DCD	TX-	DATA -
2	RXD	TX+	DATA +
3	TXD	RX+	
4	DTR	RX-	
5	GND		
6	DSR		
7	RTS		
8	CTS		
9	RI		

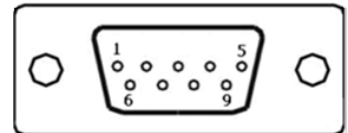

Power over Serial PIN Definitions			
Pin	RS232	RS422/485	RS485
5	GND	GND	GND
9	0/5/12V	0/5/12V	0/5/12V

DC_IN1: DC Power Input Connector (+9-48V)

Connector Type: Terminal Block 1X3 3-pin, 5.0mm pitch

Pin	Definition
1	+9-48VIN
2	Chassis GND
3	GND

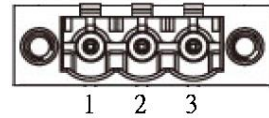

CAUTION

Please disconnect the power source before mounting the DC power cables or connecting the DC power connector to system.

DIO1: Digital Input / Output Connector

Connector Type: Terminal Block 2X5 10-pin, 3.5mm pitch

Pin	Definition	Pin	Definition
1	DI1	2	DO1
3	DI2	4	DO2
5	DI3	6	DO3
7	DI4	8	DO4
9	DC INPUT	10	GND

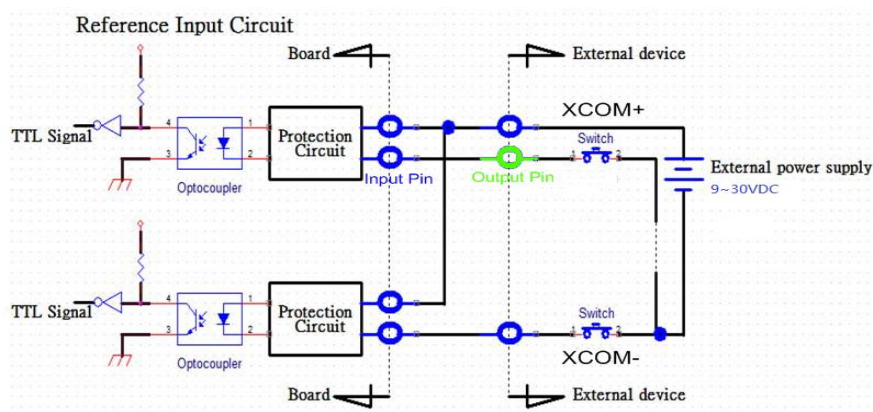
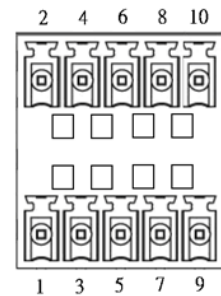

Digital Input Wiring

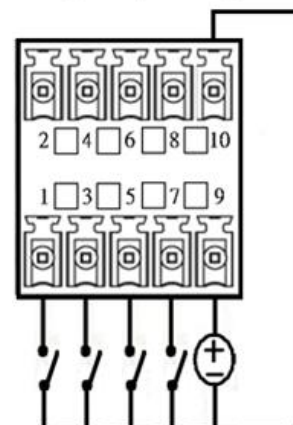

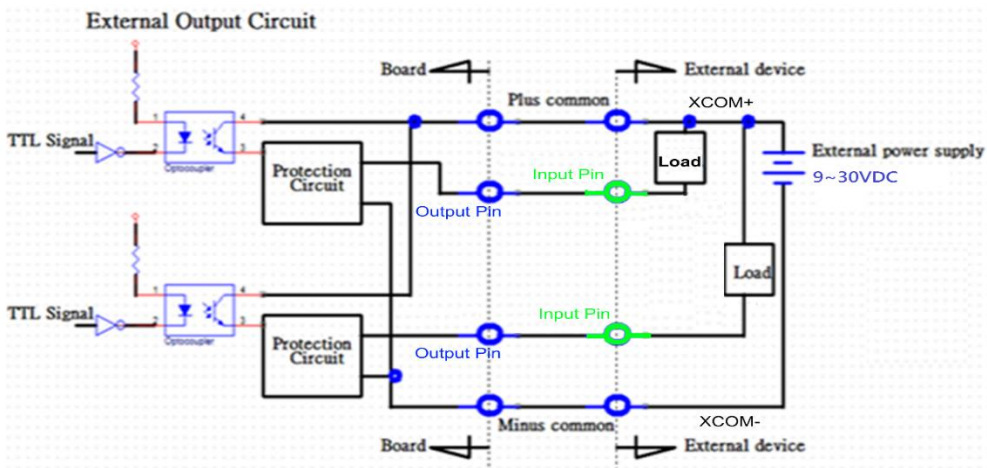

Digital Output Wiring

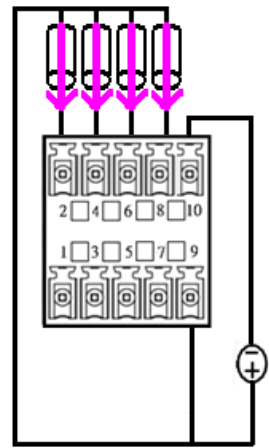

DP1: DisplayPort Connector

Pin	Definition	Pin	Definition
1	DPC_LANE0_P	11	GND
2	GND	12	DPC_LANE3_N
3	DPC_LANE0_N	13	GND
4	DPC_LANE1_P	14	GND
5	GND	15	DPC_AUX_P
6	DPC_LANE1_N	16	GND
7	DPC_LANE2_P	17	DPC_AUX_N
8	GND	18	DPC_HPD
9	DPC_LANE2_N	19	GND
10	DPC_LANE3_P	20	DPC_PWR

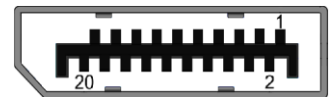

DVI_I1: DVI-I Connector

Pin	Definition	Pin	Definition
1	DVI_TX2-	16	DVI Hot Plug Detect
2	DVI_TX2+	17	DVI_TX0-
3	GND	18	DVI_TX0+
4	NC	19	GND
5	NC	20	NC
6	DDC_CLOCK	21	NC
7	DDC_DATA	22	GND
8	VGA_VSYNC	23	DVI_TXCLK+
9	DVI_TX1-	24	DVI_TXCLK-
10	DVI_TX1+	C1	VGA_RED
11	GND	C2	VGA_GREEN
12	NC	C3	VGA_BLUE
13	NC	C4	VGA_HSYNC
14	+5V	C5	GND
15	GND		

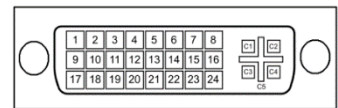

CN2: PS/2 and USB2.0 Ports

Connector Type: 6-pin Mini-DIN and dual USB 2.0 ports

Pin	Definition	Pin	Definition	Pin	Definition
1	+5V	5	+5V	9	+5V
2	USB_HUB_D1-	6	USB_HUB_D2-	10	MS_DATA
3	USB_HUB_D1+	7	USB2_HUB_D2+	11	KB_DATA
4	GND	8	GND	12	GND
				13	MS_CLK
				14	KB_CLK



CN3: LAN1 and LAN2 Ports

Connector Type: RJ45 with LEDs Port

Pin	Definition	Pin	Definition
A1	LAN1_MDI0P	A5	LAN1_MDI2N
A2	LAN1_MDI0N	A6	LAN1_MDI1N
A3	LAN1_MDI1P	A7	LAN1_MDI3P
A4	LAN1_MDI2P	A8	LAN1_MDI3N
B1	LAN2_MDI0P	B5	LAN2_MDI2N
B2	LAN2_MDI0N	B6	LAN2_MDI1N
B3	LAN2_MDI1P	B7	LAN2_MDI3P
B4	LAN2_MDI2P	B8	LAN2_MDI3N

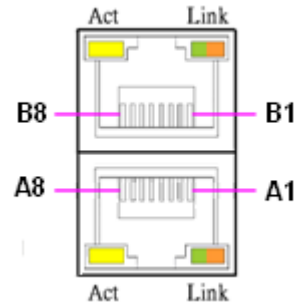

Act LED Status	Definition	Link LED Status	Definition
Blinking Yellow	Data Activity	Steady Green	1Gbps Network Link
Off	No Activity	Steady Orange	100Mbps Network Link
		Off	10Mbps Network Link

AUDIO1: Line-out Jack (Green) and Microphone Jack (Pink)

Connector Type: 5-pin Phone Jack

Pin	Definition	Pin	Definition
1	GND	22	OUT_L
2	MIC_L	23	GND
3	GND	24	OUT_JD
4	MIC_JD	25	OUT_R
5	MIC_R		

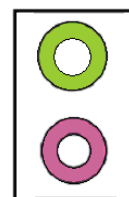

CN4: Mini PCI-Express / mSATA Socket

Pin	Definition	Pin	Definition	Pin	Definition
1	WAKE#	19	NC	37	GND
2	+3.3V	20	+3.3V	38	USB2_D+
3	NC	21	GND	39	+3.3V
4	GND	22	MINIPCIE_RST#	40	GND
5	NC	23	MINIPCIE_RXN / SATA_RXP	41	+3.3V
6	+1.5V	24	+3.3V	42	NC
7	CLKREQ#	25	MINIPCIE_RXP / SATA_RXN	43	GND
8	NC	26	GND	44	NC
9	GND	27	GND	45	NC
10	NC	28	+1.5V	46	NC
11	MINIPCIE_CLKN	29	GND	47	NC
12	NC	30	SMB_CLK	48	+1.5V
13	MINIPCIE_CLKP	31	MINIPCIE_TXN / SATA_TXN	49	NC
14	NC	32	SMB_DATA	50	GND
15	GND	33	MINIPCIE_TXP / SATA_TXP	51	NC
16	NC	34	GND	52	+3.3V
17	NC	35	GND		
18	GND	36	USB2_D-		

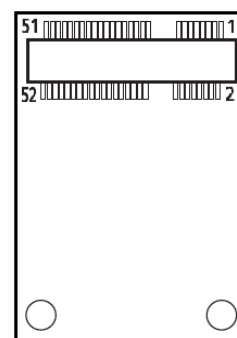

MINIPCIE1: Mini PCI-Express Socket

Pin	Definition	Pin	Definition	Pin	Definition
1	WAKE#	19	NC	37	GND
2	+3.3V	20	+3.3V	38	USB2_D+
3	NC	21	GND	39	+3.3V
4	GND	22	MINIPCIE_RST#	40	GND
5	NC	23	MINIPCIE_RXN7	41	+3.3V
6	+1.5V	24	+3.3V	42	NC
7	CLKREQ#	25	MINIPCIE_RXP7	43	GND
8	UIM_PWR	26	GND	44	NC
9	GND	27	GND	45	NC
10	UIM_DATA	28	+1.5V	46	NC
11	MINIPCIE_CLKN	29	GND	47	NC
12	UIM_CLK	30	SMB_CLK	48	+1.5V
13	MINIPCIE_CLKP	31	MINIPCIE_TXN	49	NC
14	UIM_RESET	32	SMB_DATA	50	GND
15	GND	33	MINIPCIE_TXP	51	NC
16	UIM_VPP	34	GND	52	+3.3V
17	NC	35	GND		
18	GND	36	USB2_D-		

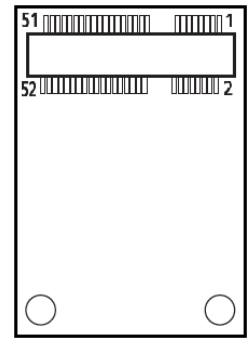

PCIE2: PCI-Express X1 Socket

Connector Type: PCI-Express X1 Slot

Pin	Definition	Pin	Definition
A1	CPUFAN_CONTROL	B1	+12V
A2	+12V	B2	+12V
A3	+12V	B3	+12V
A4	GND	B4	GND
A5	NC	B5	SMB_CLK
A6	NC	B6	SMB_DATA
A7	NC	B7	GND
A8	NC	B8	+3.3V
A9	+3.3V	B9	NC
A10	+3.3V	B10	+3.3VSB
A11	PCIE_RESET#	B11	PCIE_WAKE#
A12	GND	B12	+12V
A13	PCIE_CLKP	B13	GND
A14	PCIE_CLKN	B14	PCIE_TXP
A15	GND	B15	PCIE_TXN
A16	PCIE_RXP	B16	GND
A17	PCIE_RXN	B17	CPUFAN_SENSE
A18	GND	B18	GND

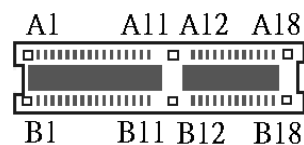

POWER1: Power Connector

Connector Type: 1X4-pin Wafer, 2.54mm pitch

Pin	Definition
1	+5V
2	GND
3	GND
4	+12V

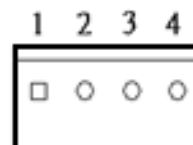

POWER2: Power Connector

Connector Type: 1X4-pin Wafer, 2.0mm pitch

Pin	Definition
1	+5V
2	GND
3	GND
4	+12V

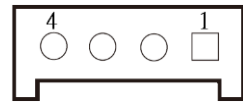

USB2_1, USB2_2: USB2.0 Connector, Type A

Pin	USB2_1 Definition	USB2_2 Definition
1	+5V	+5V
2	USB_HUB_D3-	USB_HUB_D4-
3	USB_HUB_D3+	USB_HUB_D4+
4	GND	GND

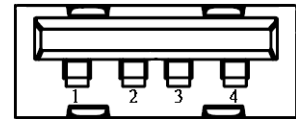

USB3_1: USB 3.0 Port, Type A

Pin	Definition	Pin	Definition
1	+5V	6	USB3_RX+
2	USB_HUB_D5-	7	GND
3	USB_HUB_D5+	8	USB3_TX-
4	GND	9	USB3_TX+
5	USB3_RX-		

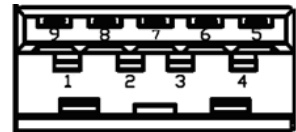



Chapter 3

System Setup

This chapter takes DE-1000 as an example to demonstrate the installation of hardware components, except for chapter 3.12.

3.1 Remove the Chassis Bottom Cover



WARNING

In order to prevent electric shock or system damage, before removing the chassis cover, must turn off power and disconnect the unit from power source.

1. Flip over the unit to have the bottom side up. Loosen the 6 screws from bottom cover and place them aside for later use.



2. Remove the bottom cover from the chassis.



3.2 Removing the Chassis

1. Loosen 4 screws as they are marked on photo, remove the base holders, and place them aside for later use.

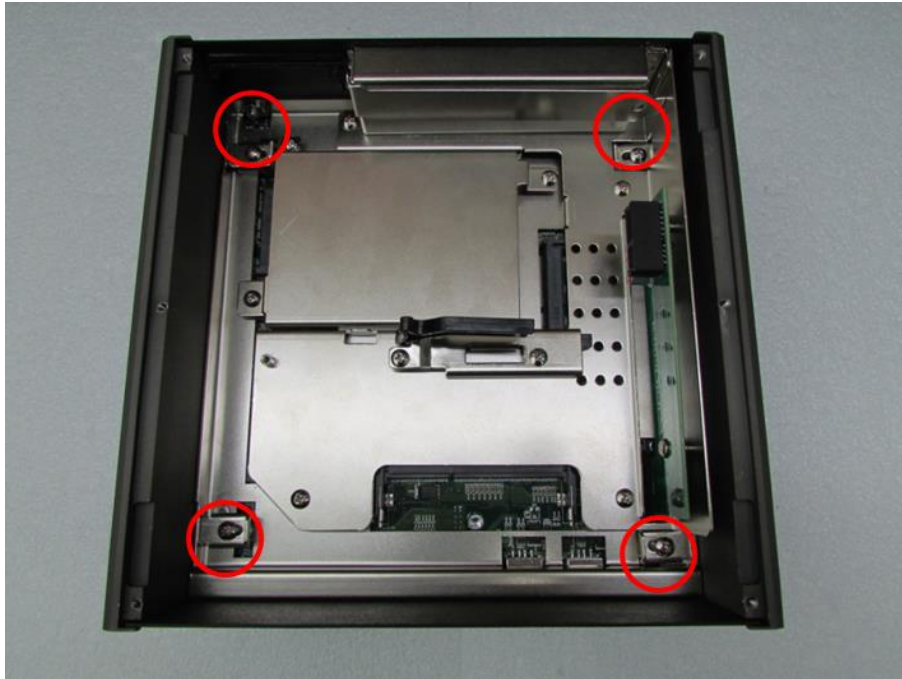

2. Lift up the body unit vertically by holding the front and rear panel.

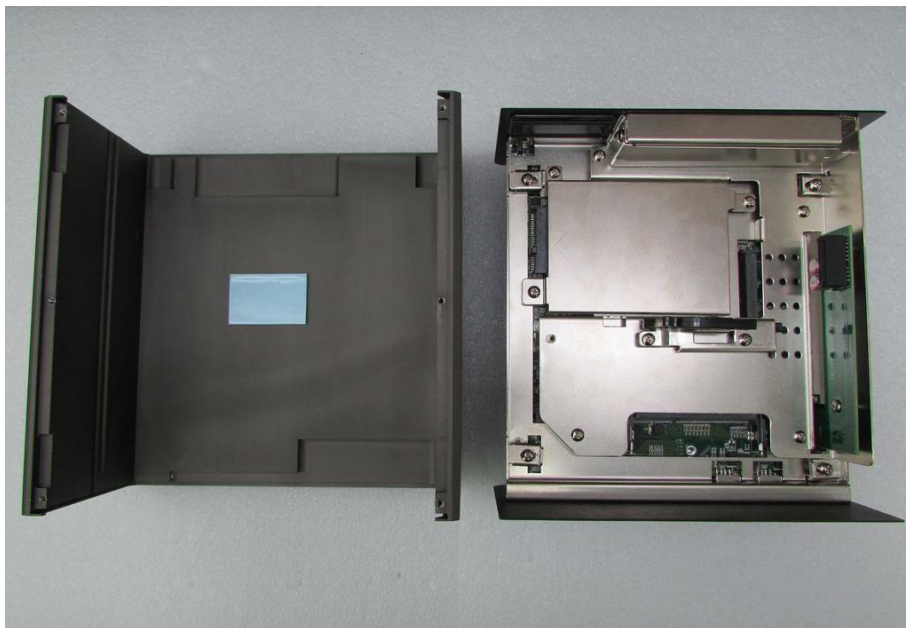

3.3 Installing a Half Size Mini PCIe Card on Upper Side

1. Flip over the body unit and place it on the table gently.

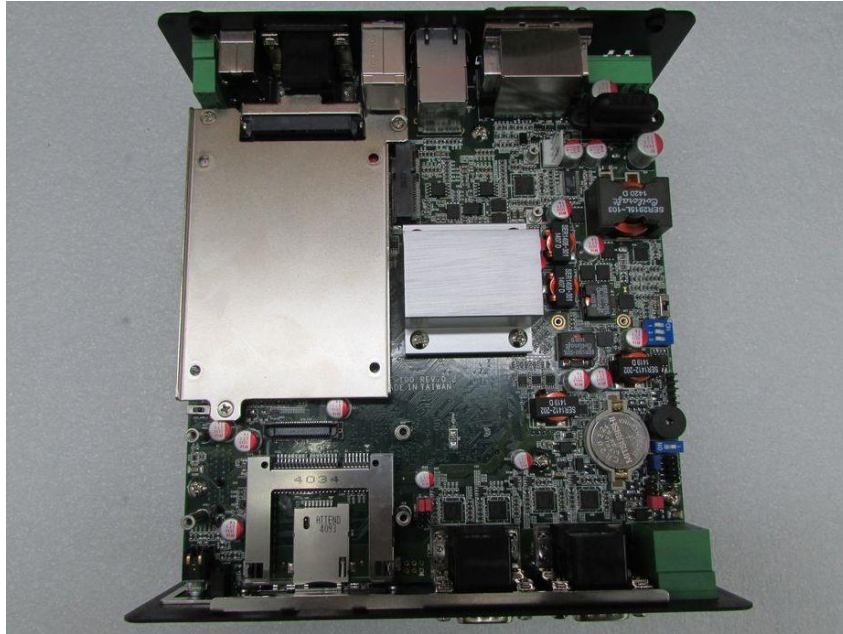

2. Locate the Mini PCIe slot.

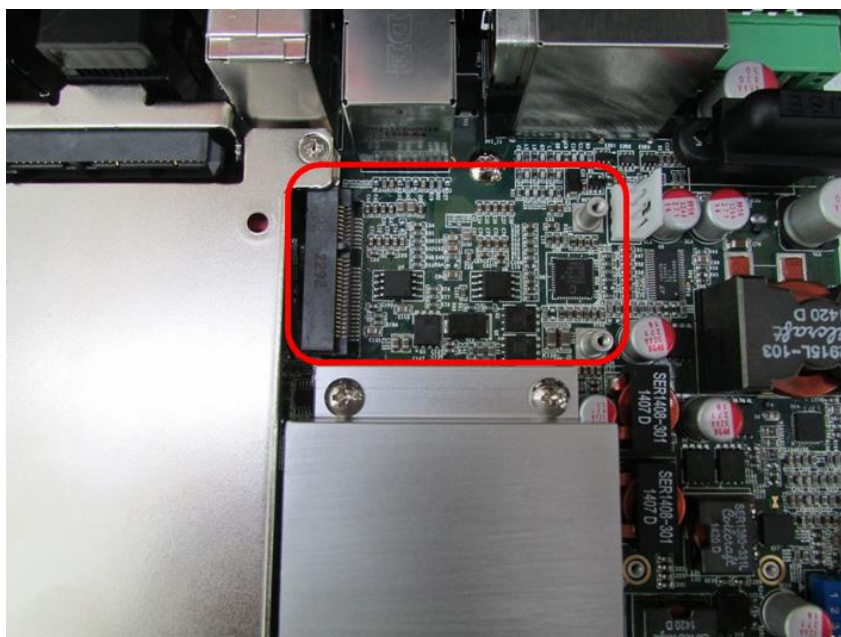

3. Fasten the module and bracket together with 2 screws.



4. Tilt the Mini PCIe module at 45-degree angle and insert it to the Mini PCIe slot. Be sure the gold-plated connects to the Mini PCIe slot firmly.

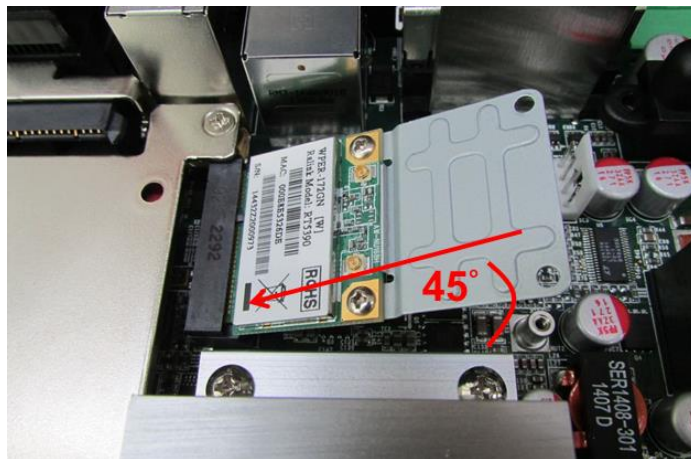

5. Press down the module and fasten the module with 2 screws.

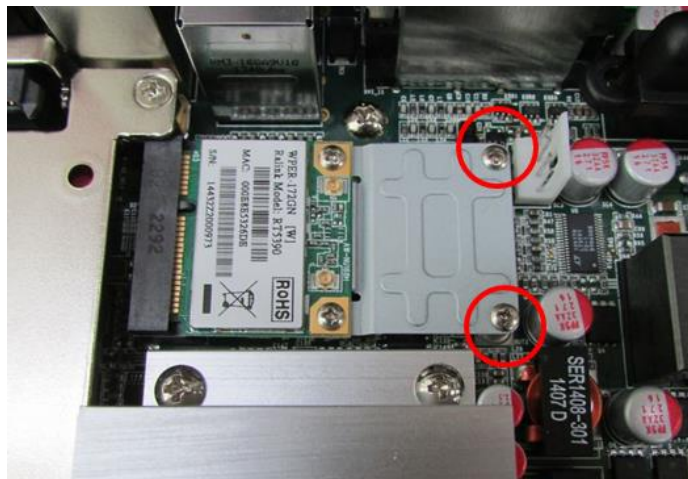

3.4 Installing a Full Size Mini PCIe Card on Upper Side

1. Flip over the body unit and place it on the table gently.



2. Locate the Mini PCIe slot.

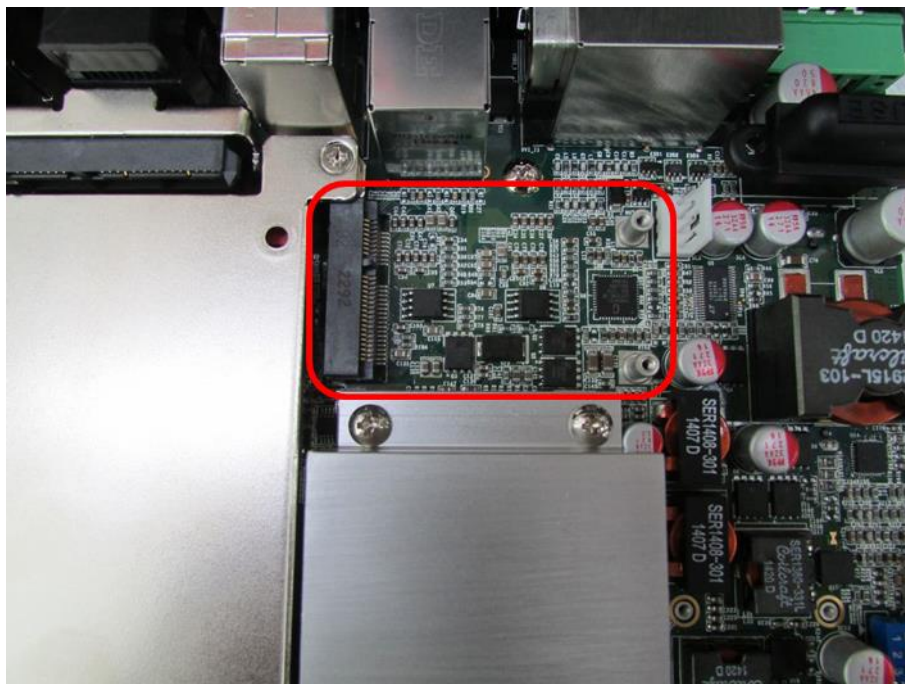

3. Tilt the Mini PCIe module at 45-degree angle and insert it to the Mini PCIe slot. Be sure the gold-plated connects to the Mini PCIe slot firmly.

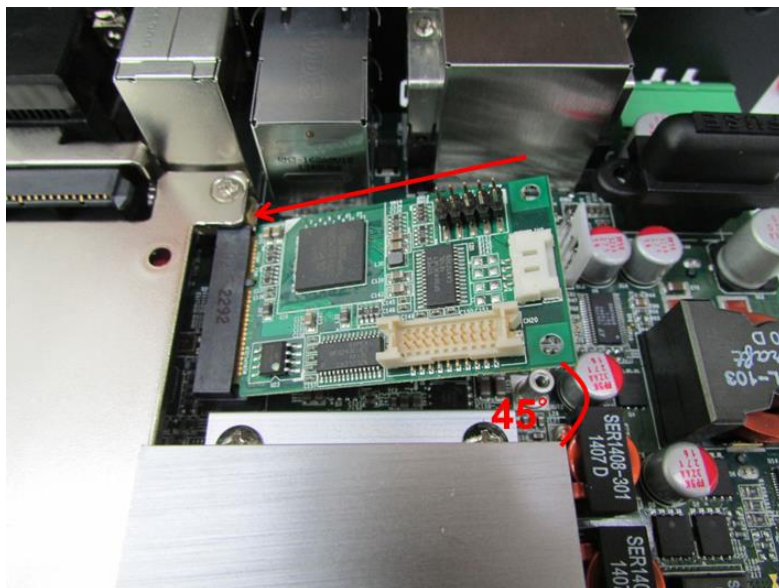

4. Press down the module and fasten the module with 2 screws.

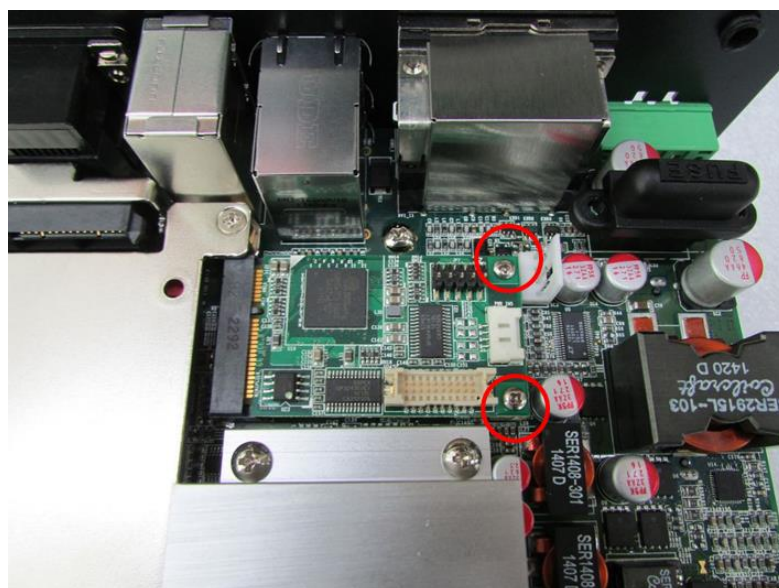

3.5 Installing Antenna

1. Remove the antenna covers on rear panel.



2. Have antenna jack penetrate through the hole.



3. Place on washer and fasten the nut with antenna jack.



4. Assemble the antenna and antenna jack together.



5. Attach the RF connector at the other end of cable onto the module.

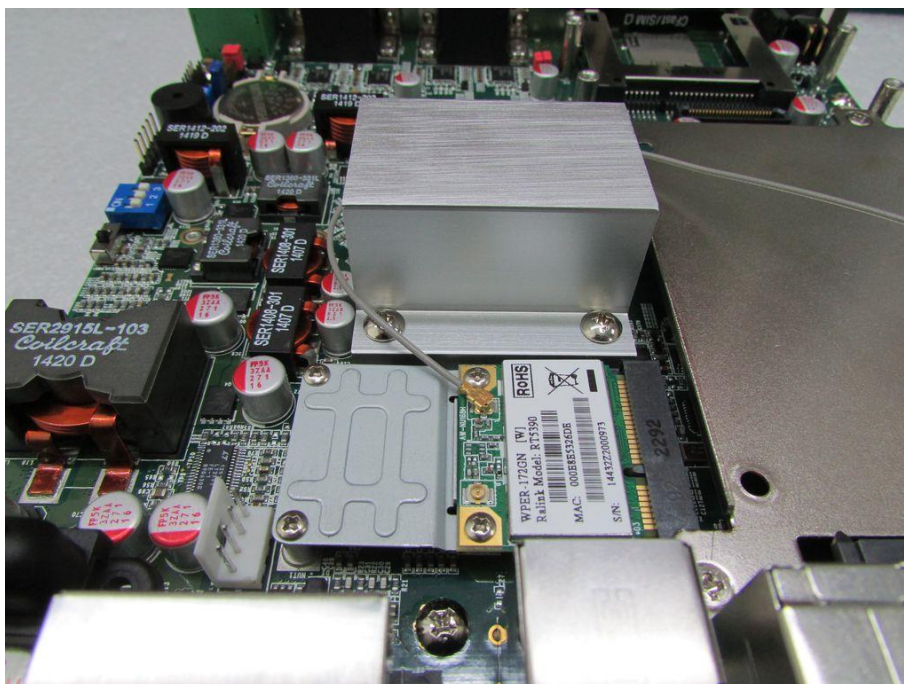

3.6 Installing a SATA Hard Drive on Upper Side

1. Flip over the body unit and place it on the table gently.

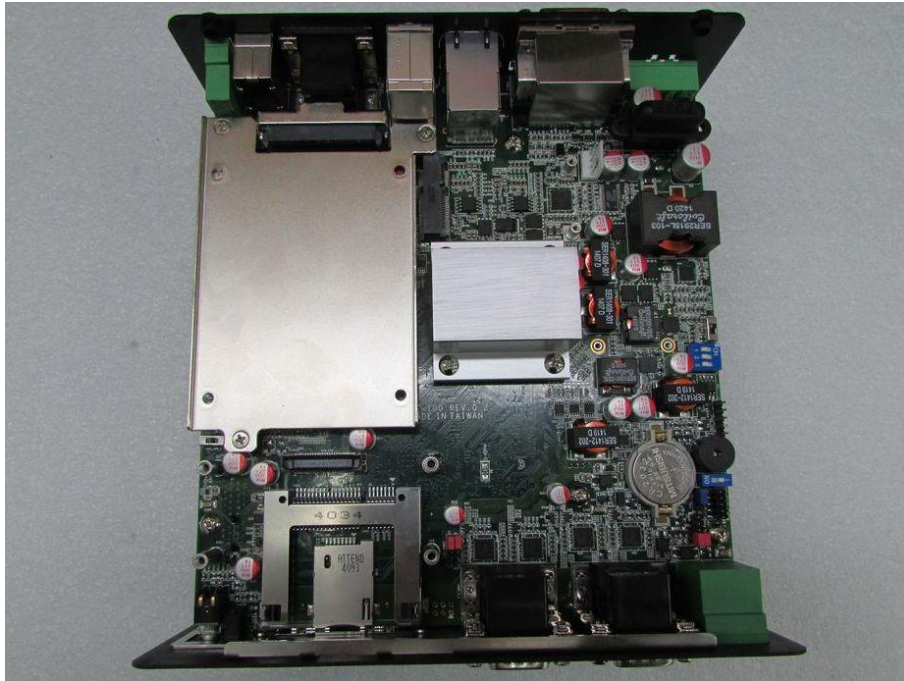

2. Loosen the 3 screws on HDD bracket and remove the bracket.

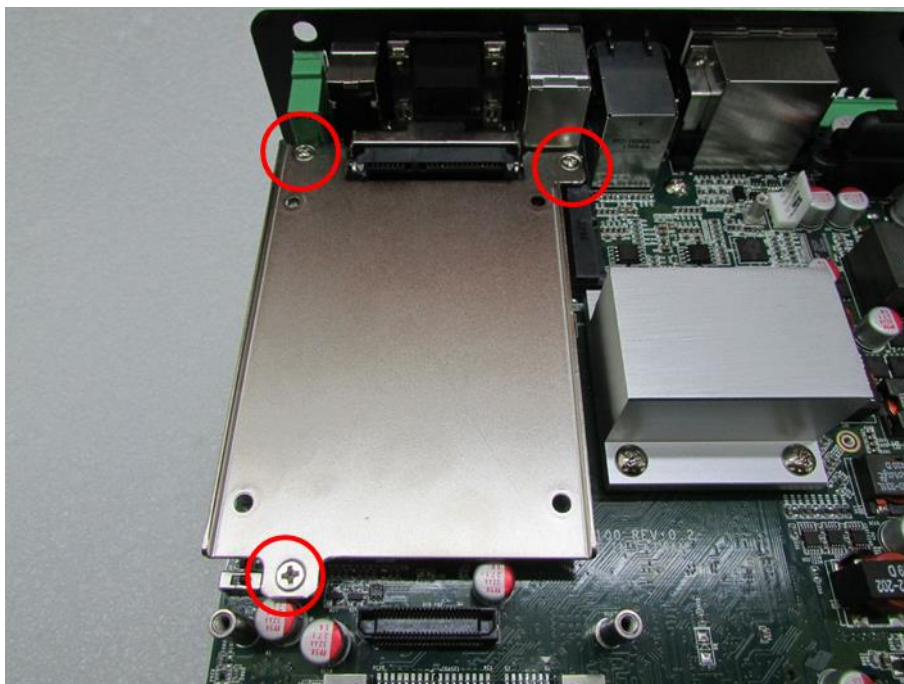

3. To have PCB side up, place the HDD bracket on it. Ensure the direction of bracket is correct and use 4 provided screws to fasten HDD and HDD bracket together.



4. Flip over the HDD bracket. Connect the HDD bracket to the SATA connector and fasten it with 3 screws.

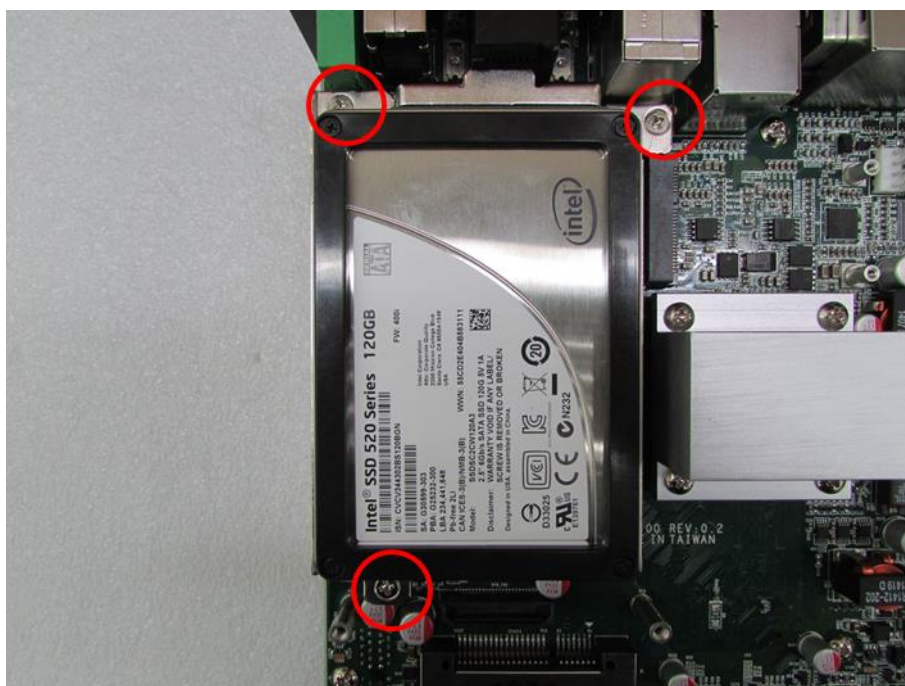

3.7 Installing a SATA Hard Drive on Bottom Side

1. Flip over the body unit and locate SATA socket on the bottom side. Loosen the 3 screws on HDD bracket and remove the bracket.

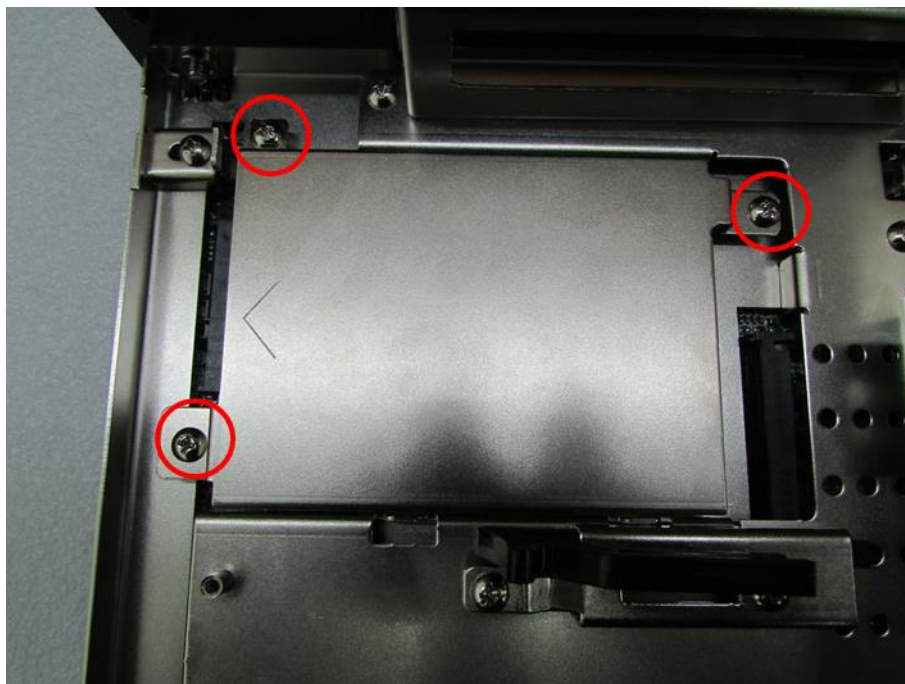

2. To have the PCB side up, and place the HDD on HDD bracket. Ensure the direction of bracket is correct and use 4 provided screws to fasten HDD and HDD bracket together.

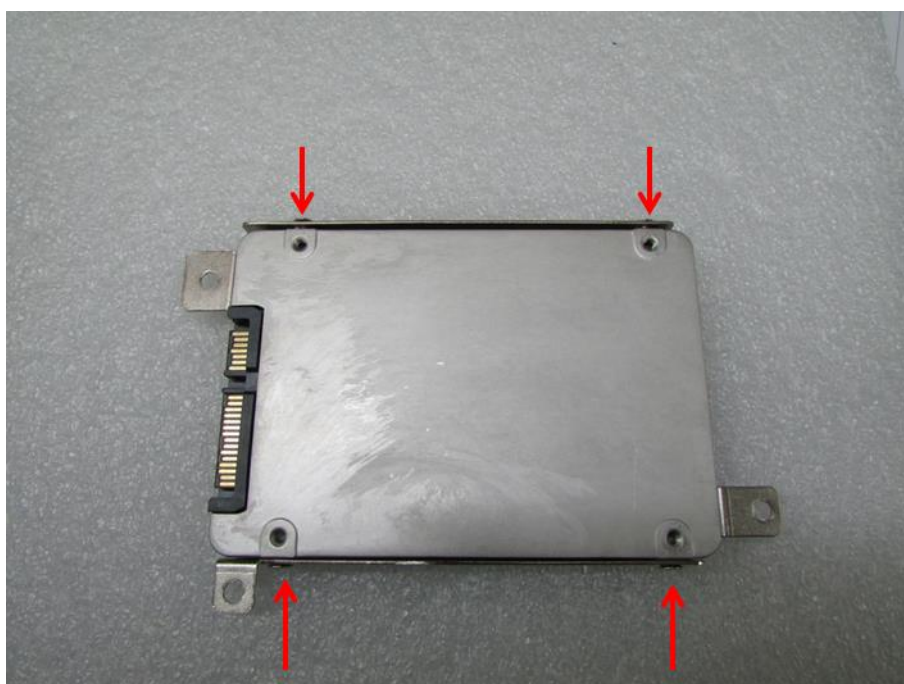

3. Flip over the HDD bracket. Connect the HDD bracket to SATA connector and fasten it with 3 screws.

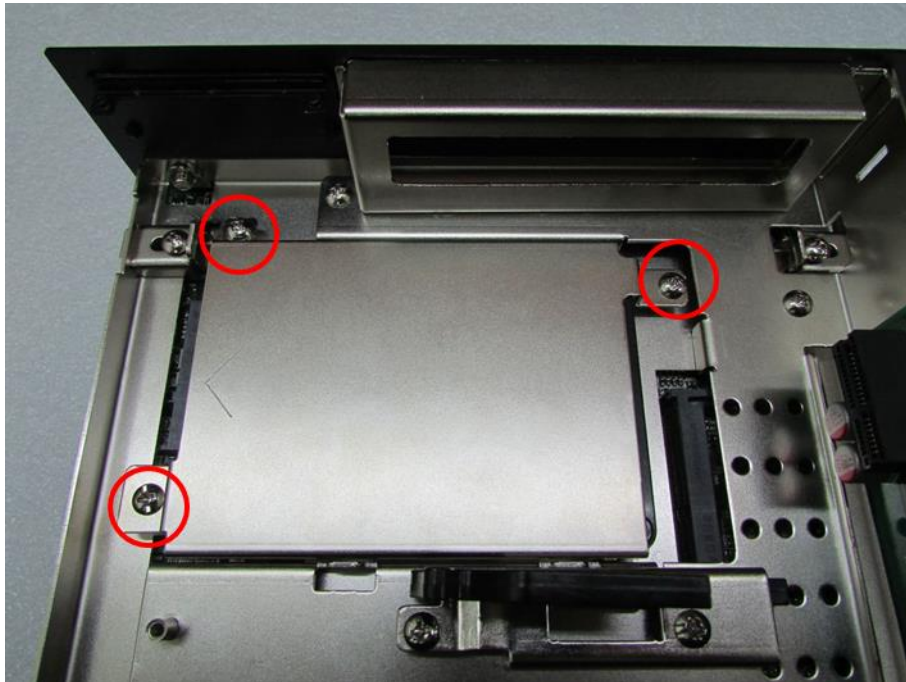

3.8 Installing SO-DIMM 1

1. Flip over the body unit and locate SO-DIMM socket on the bottom.

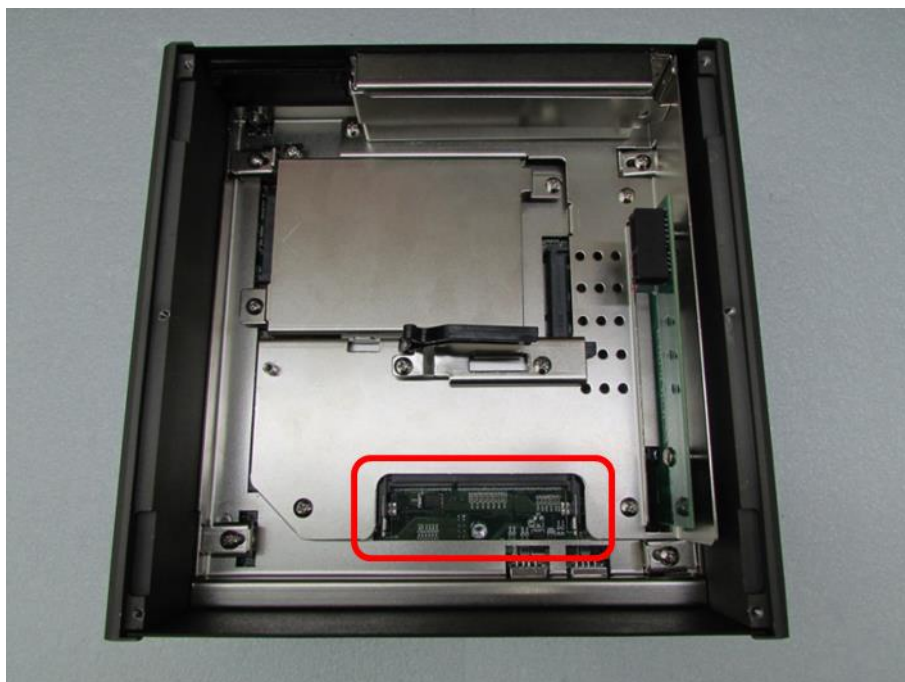

2. Tilt the SO-DIMM module at 45-degree angle and insert it to SO-DIMM socket. Be sure the gold-plated connects to SO-DIMM slot firmly.

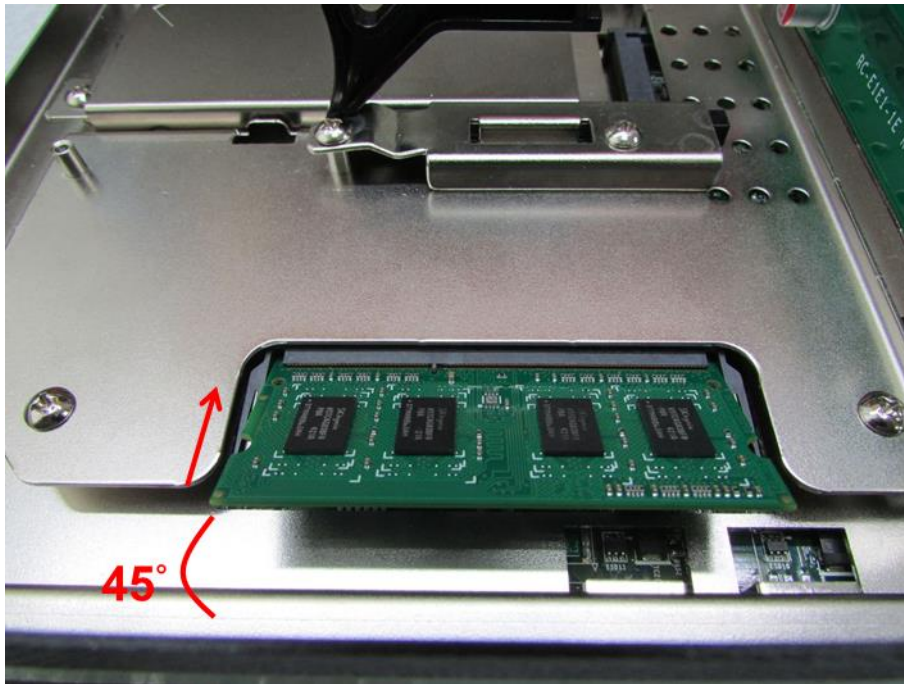

3. Press the module down until its fixed firmly by the two locking latches on each side.

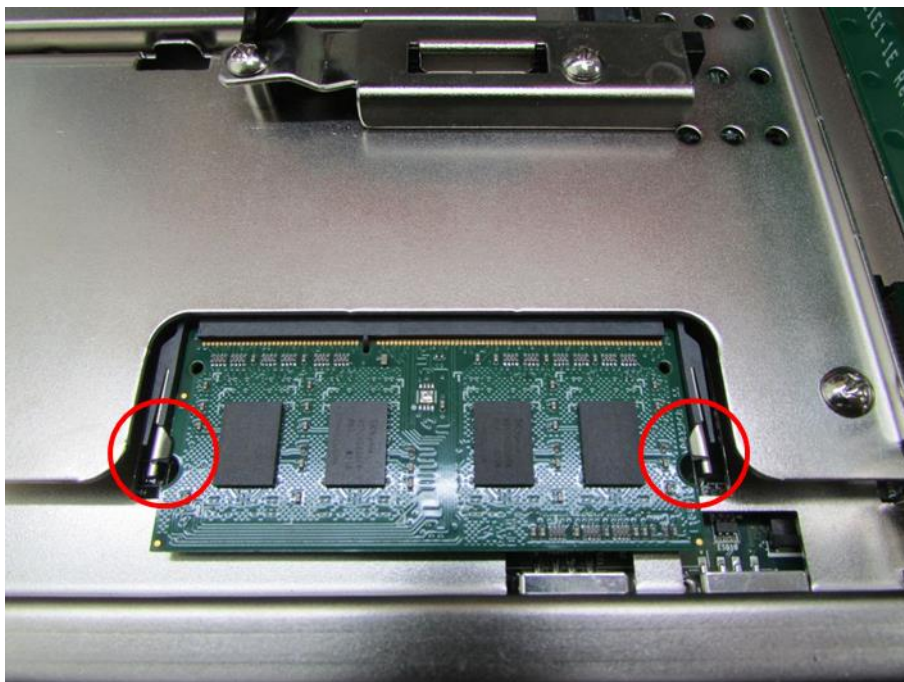

3.9 Installing SO-DIMM 2

1. Flip over the body unit and locate SO-DIMM socket on the bottom. Loosen screws and take expansion module out of system.

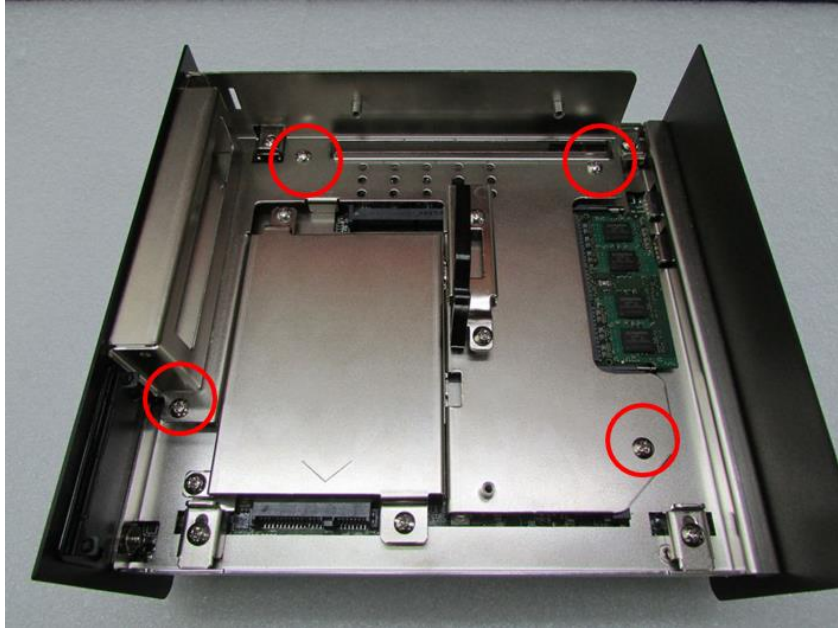

2. Locate SO-DIMM socket on the bottom.

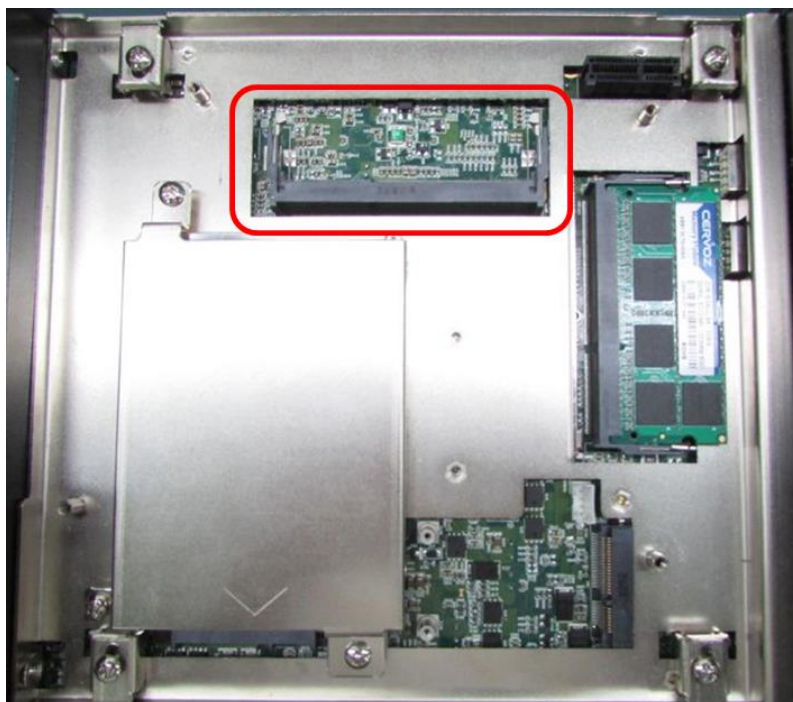

3. Tilt the SO-DIMM module at 45-degree angle and insert it to SO-DIMM socket. Be sure the gold-plated connects to SO-DIMM socket firmly.



4. Press the module down and it's fixed firmly by the two locking latches on each side.



5. Place the expansion module back to chassis and fasten it with screws afterwards.

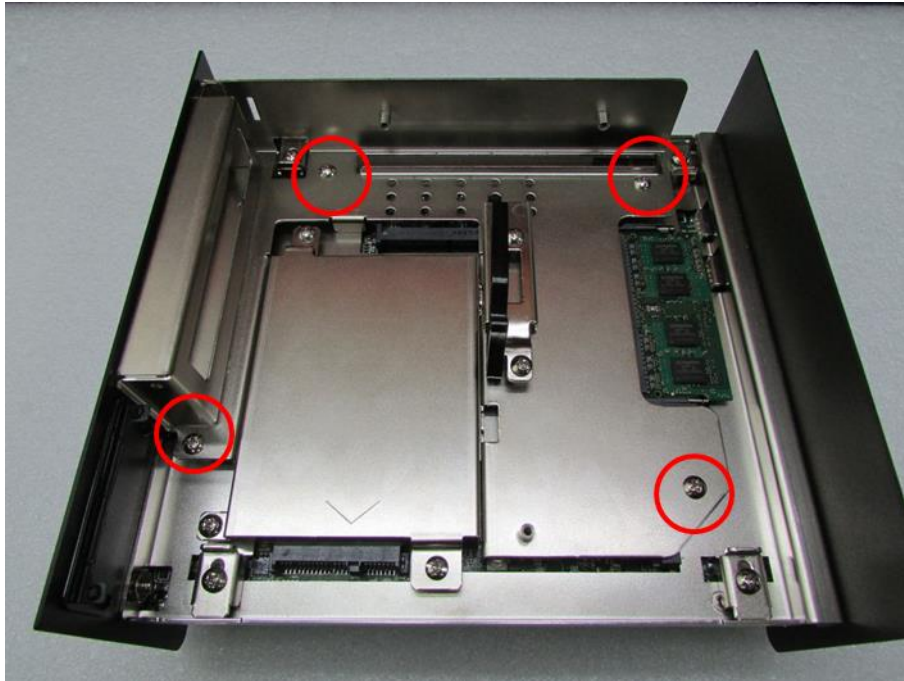

3.10 Installing Half Size Mini PCIe Card on Bottom Side

1. Flip over the body unit and locate Mini PCIe or mSATA slot on the bottom side. Loosen screws and take expansion module out of system gently.

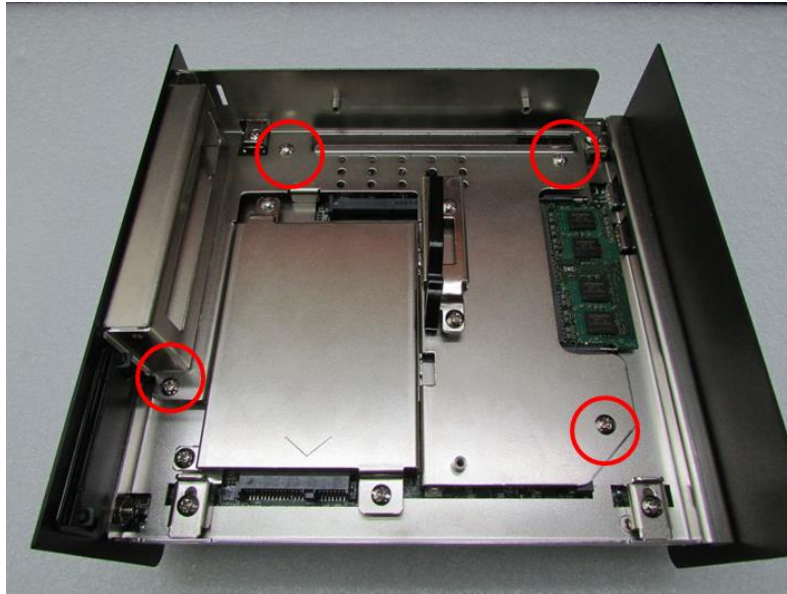

2. Locate the Mini PCIe slot.

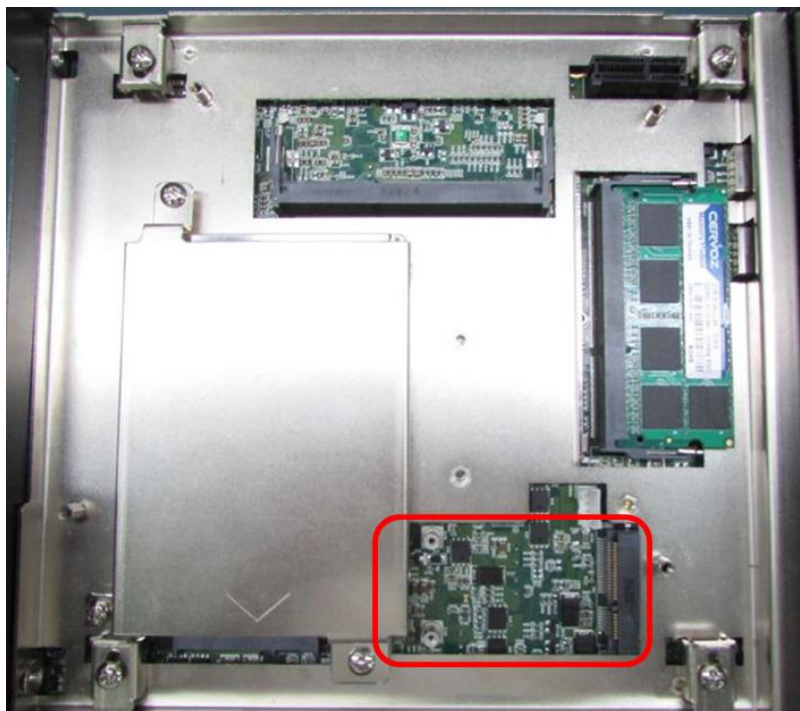

3. Fasten the module and bracket together with 2 screws.



4. Tilt the Mini PCIe module at 45-degree angle and insert it to Mini PCIe slot. Be sure the gold-plated connects to the Mini PCIe slot firmly.



5. Press down the module and use previous two screws to fix the module.



6. Press down the module and use previous two screws to fix the module.

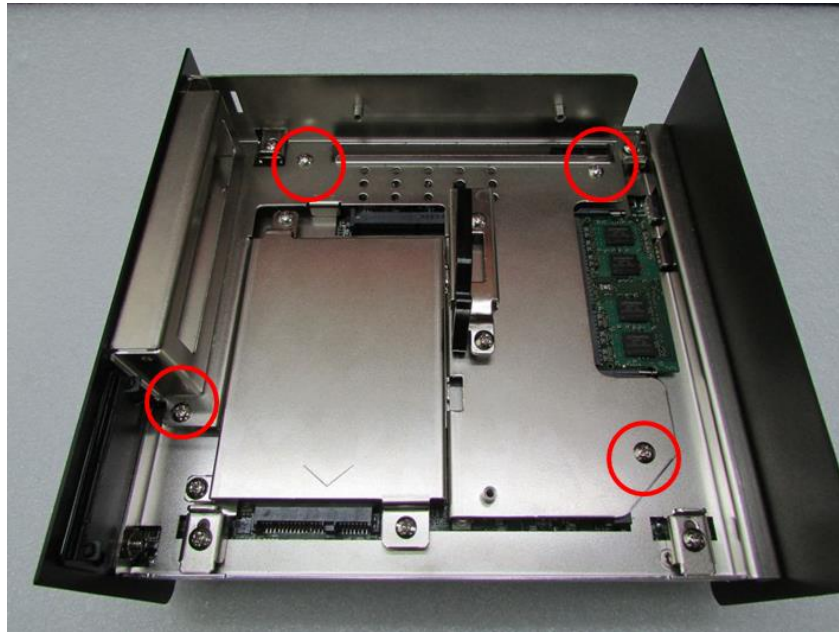

3.11 Installing Full Size Mini PCIe Cards on Bottom Side

1. Flip over the body unit and locate Mini PCIe or mSATA slot on the bottom. Loosen screws and take expansion module out of system.

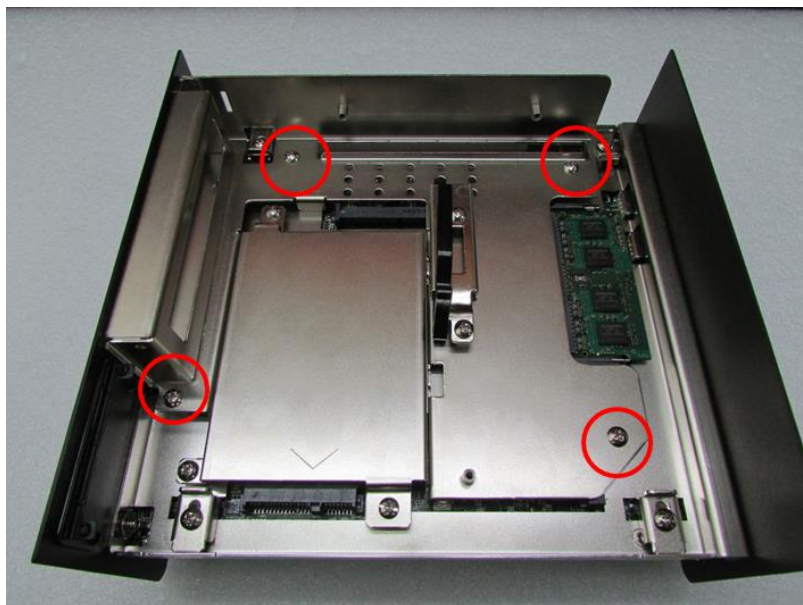

2. Locate the Mini PCIe slot.

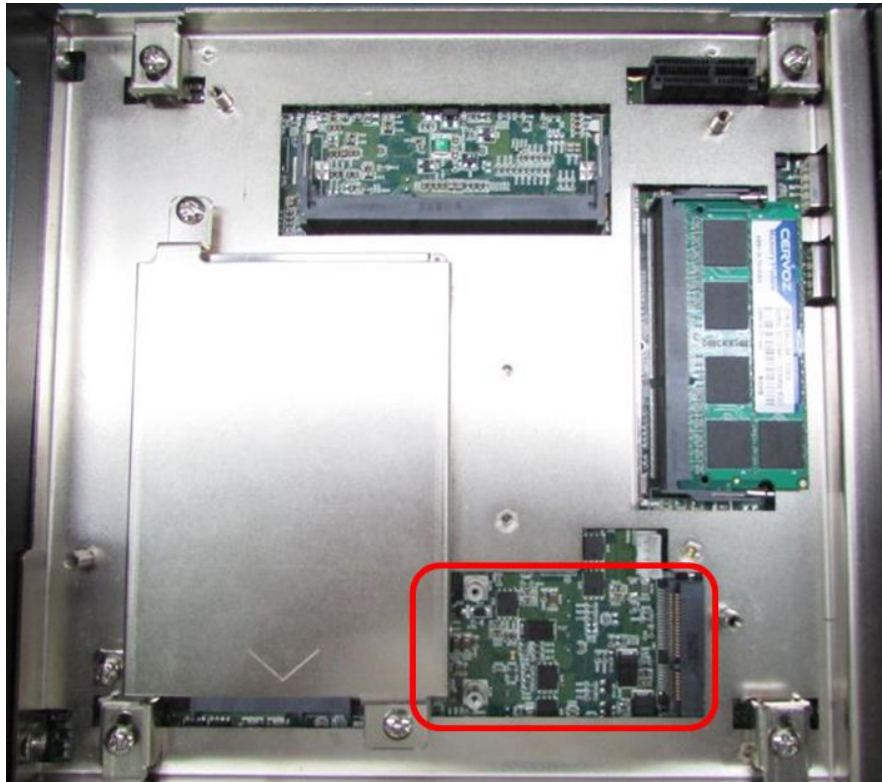

3. Tilt the Mini PCIe or mSATA module at 45-degree angle and insert it to Mini PCIe slot. Be sure the gold-plated connects to the Mini PCIe slot firmly.

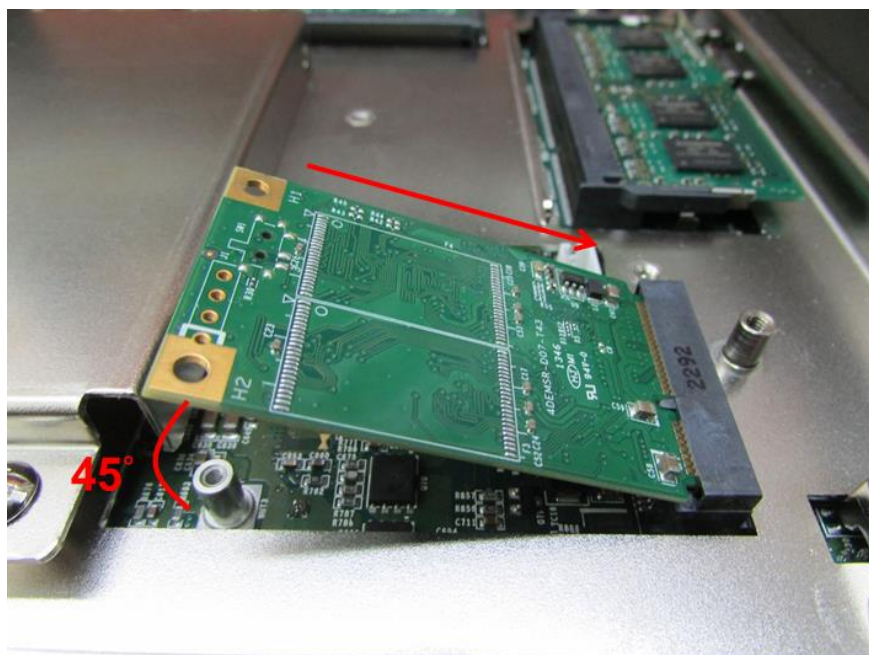

4. Press down the module and use previous two screws to fix the module.

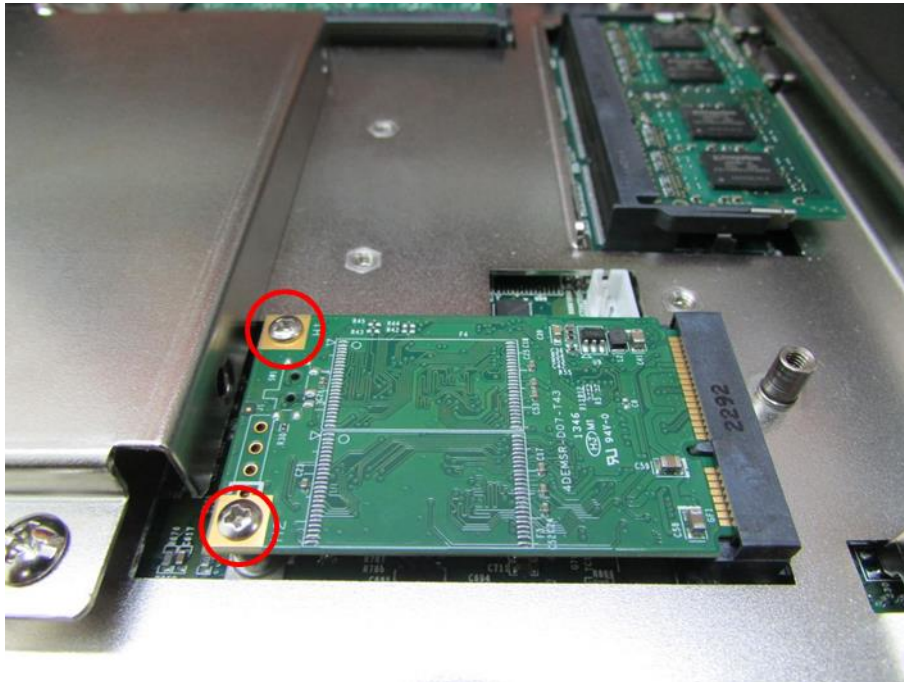

5. Place the expansion module back to chassis and fasten the screws afterwards.

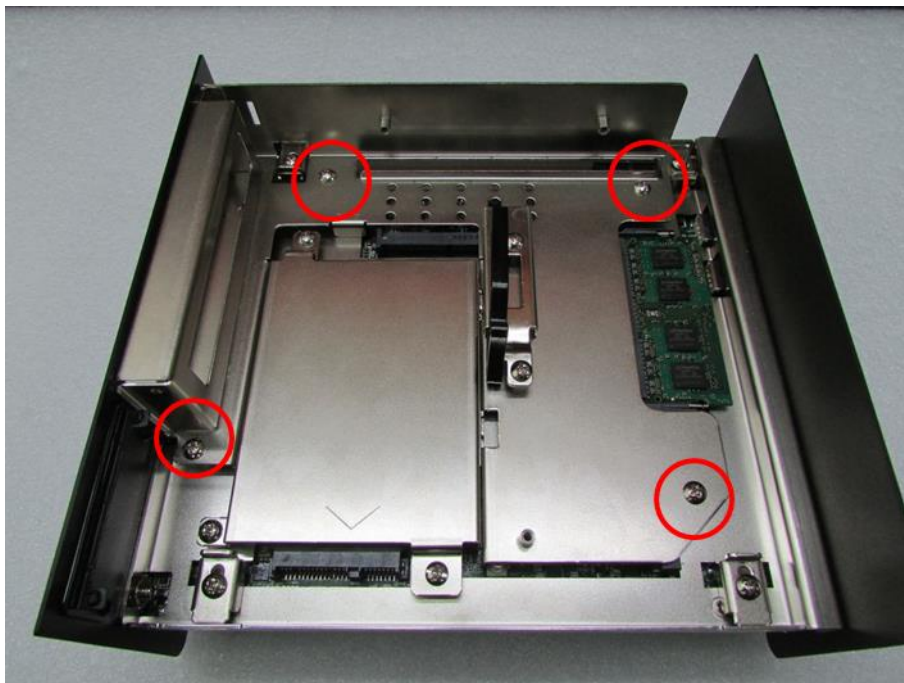

3.12 Installing the PCI/PCIe Cards on Expansion Module (DE-1001 and DE-1002 Only)

1. Locate the PCI/ PCIe expansion module, loosen screws, and take expansion module out of system (Take DE-1001 for example).

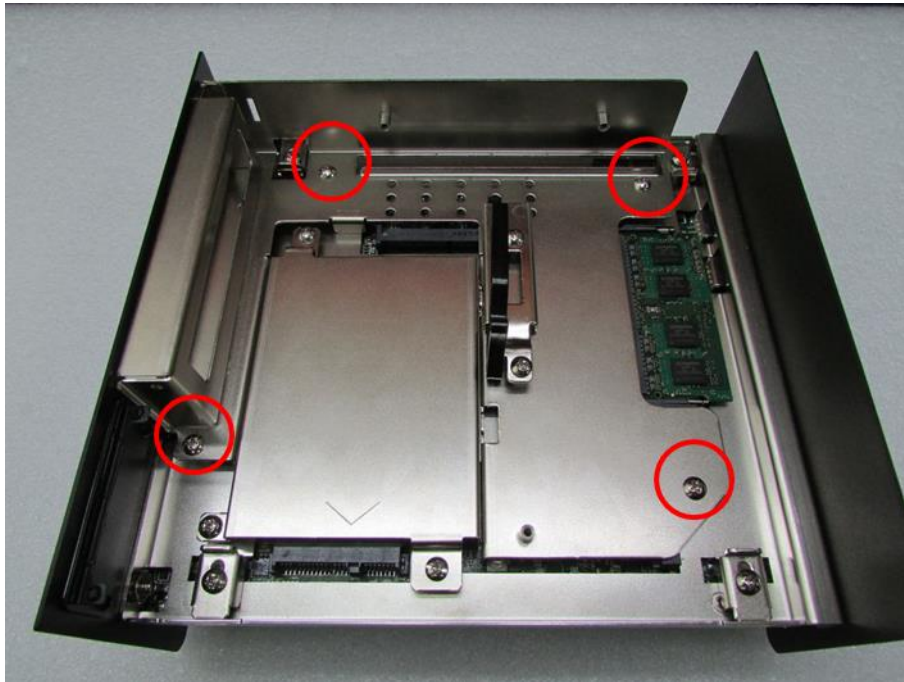

2. Loosen the screw on PCI bracket to remove the bracket.

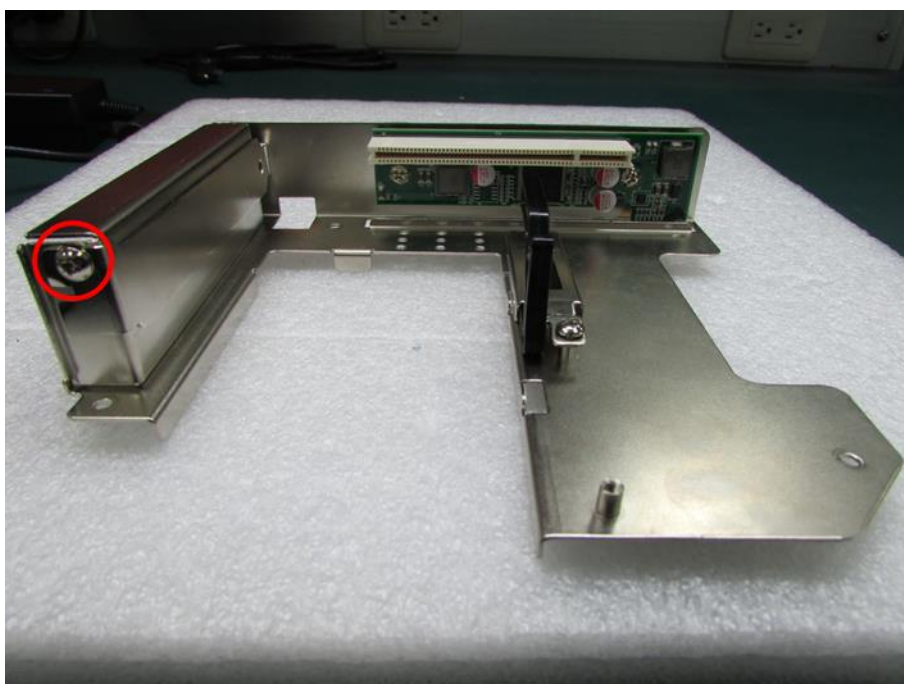

3. Loosen the screw to remove the card retainer.

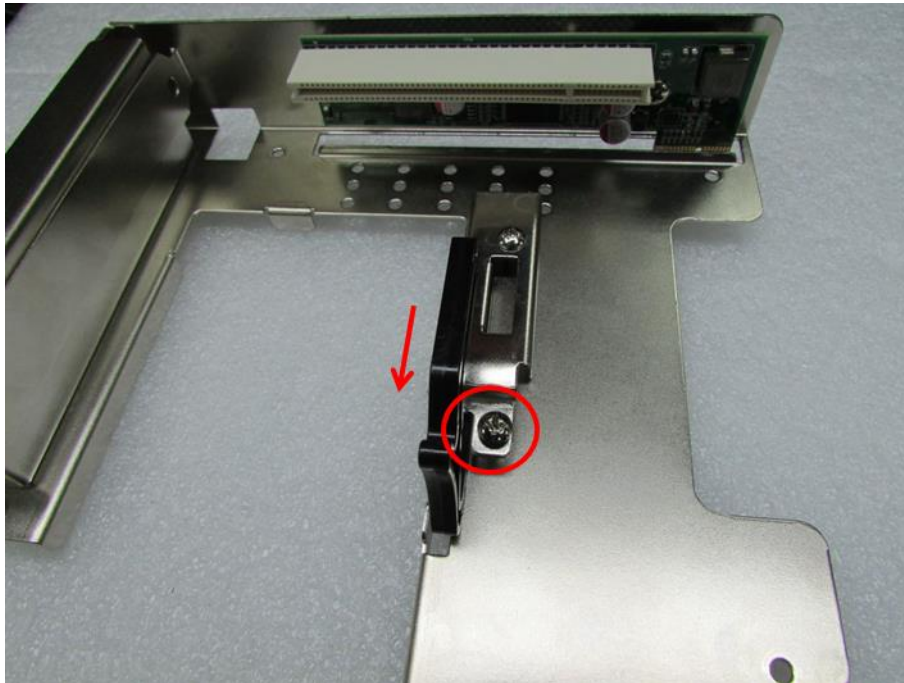

4. Please check the following photos for instruction of placing expansion module. Insert the PCI or PCIe card to the slot and fasten the screw on PCI bracket.

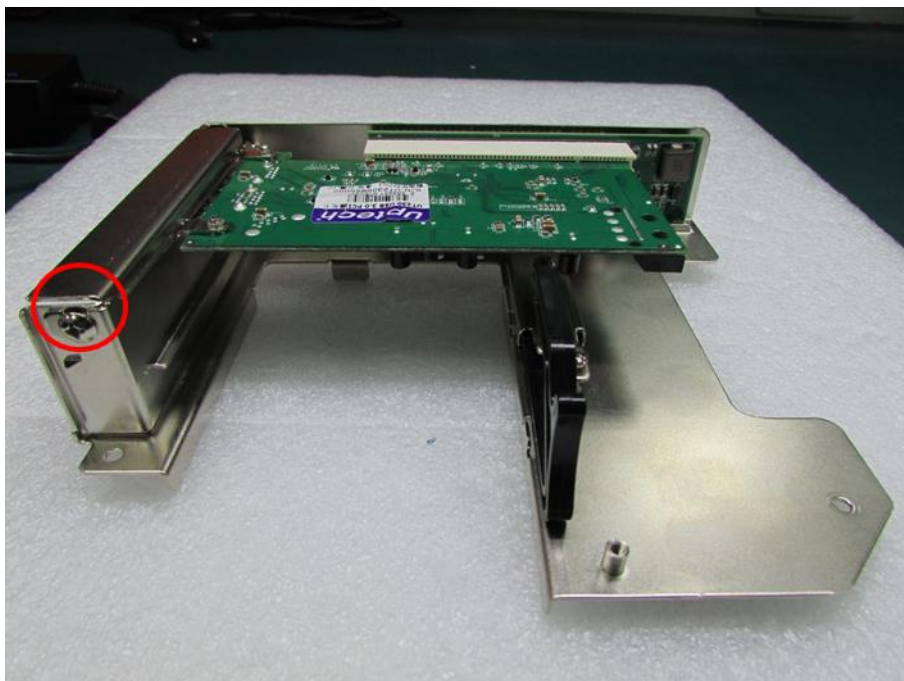

5. Before fastening the screw, you need to have the edge of PCI or PCIe module in the grooves properly. Be sure the card retainer holds the expansion module firmly.

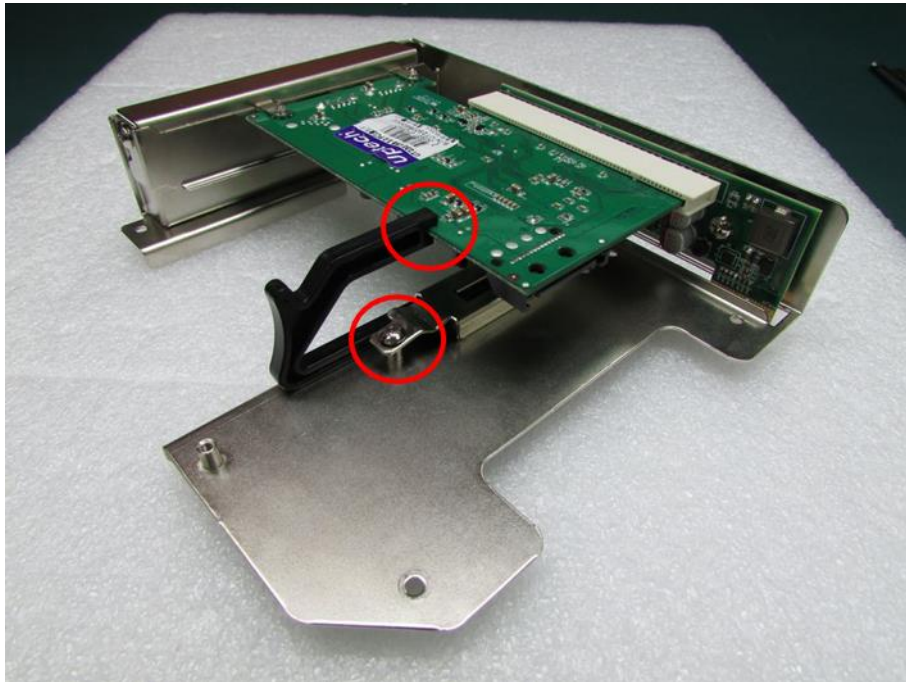

6. Place the expansion module back to chassis and fasten the screws afterwards.



3.13 Installing the Chassis

1. Be sure to align the grooves with front and rear panels. Put the cover back on and fasten the screws to fix the cover.

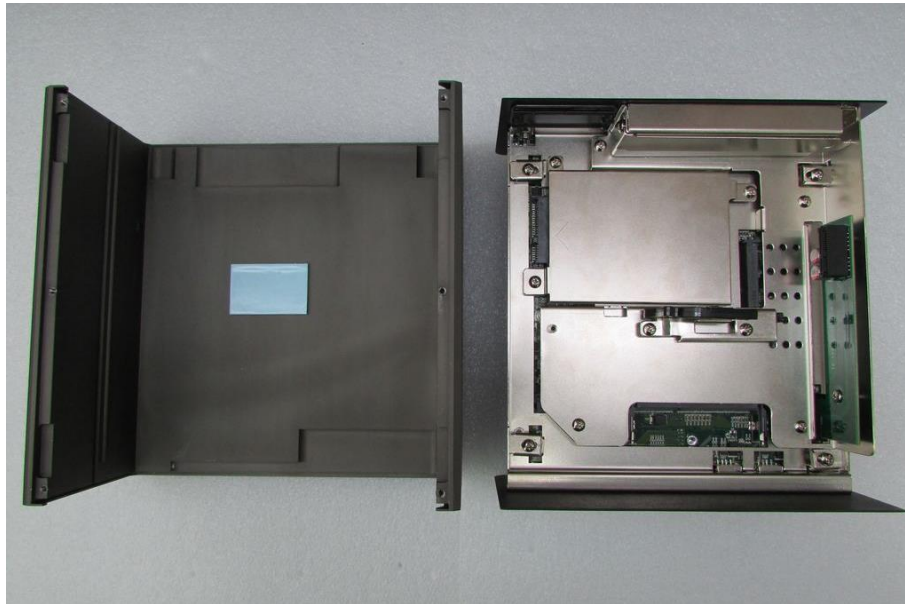

2. When place back the body of unit, you need to have 4 pieces of base holders and edges of front and rear panels are in the chassis grooves in order to assemble the body onto chassis firmly. Fasten the base holders with 4 screws afterwards.

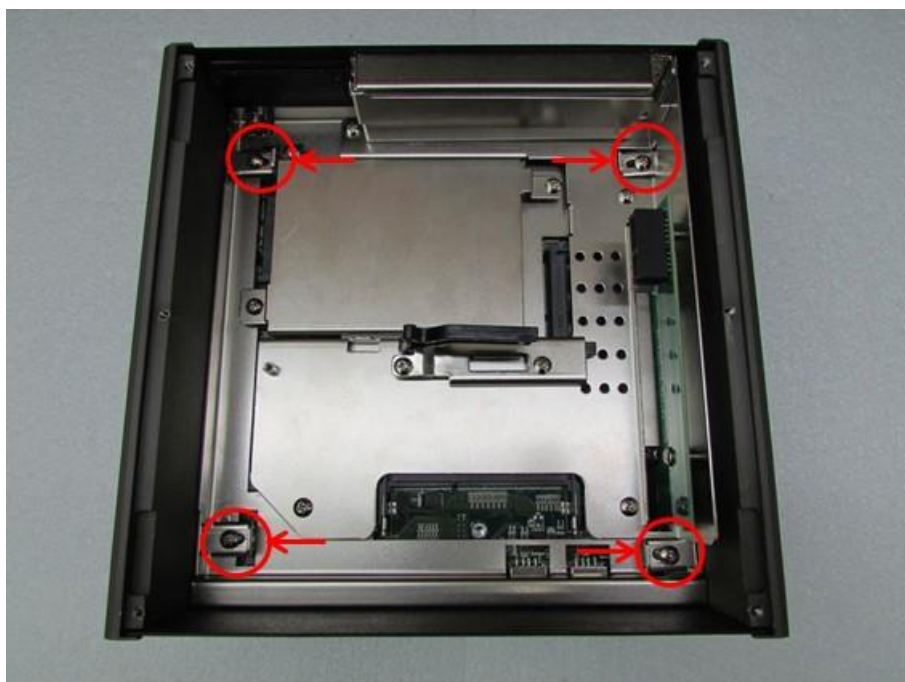

3.14 Installing the Chassis Bottom Cover

1. Be sure to align the grooves with front and rear panels. Have the bottom cover back on the system and fasten the screws to fix the cover.



3.15 Installing a SIM Card

1. Loosen the screws in order to remove the expansion plate in the front.



2. Locate the SIM card slot to insert SIM card (according to the icon instruction aside).

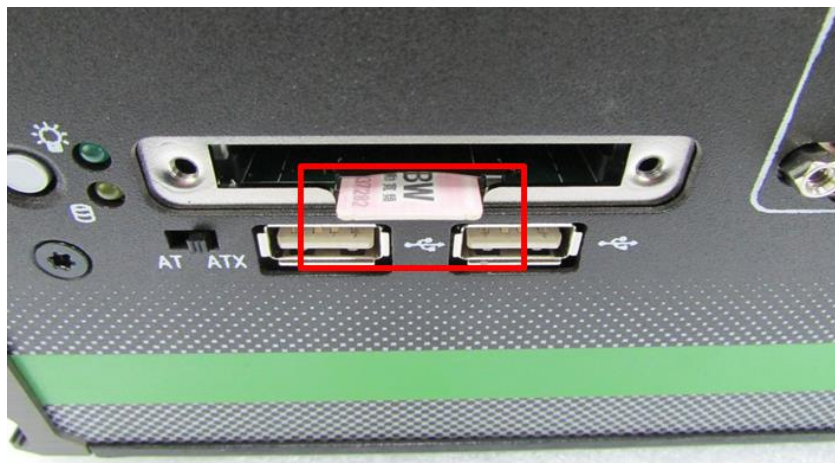

3. Fasten the cover back on by using 2 screws.



3.16 Installing a CFast Card

1. Loosen the screws in order to remove the expansion plate in the front.



2. Locate the CFast card slot to insert the CFast card.



3. Fasten the cover back on by using 2 screws.



3.17 Wall Mount Bracket

DE-1000 series offers wall mount that customers can install system on the wall in convenient and economical ways.



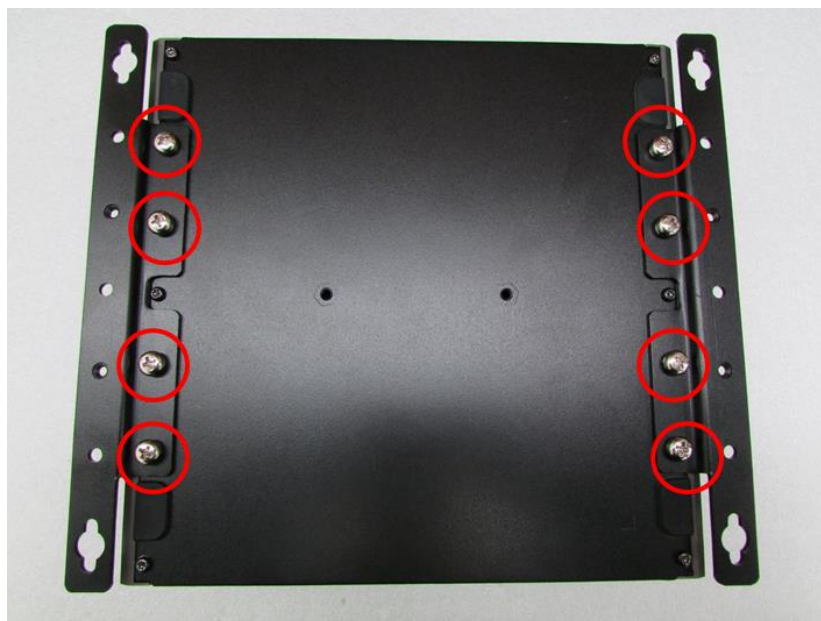

1. The mounting holes are on the bottom of system. Use provided 8 screws to fasten the brackets on each side of the system.

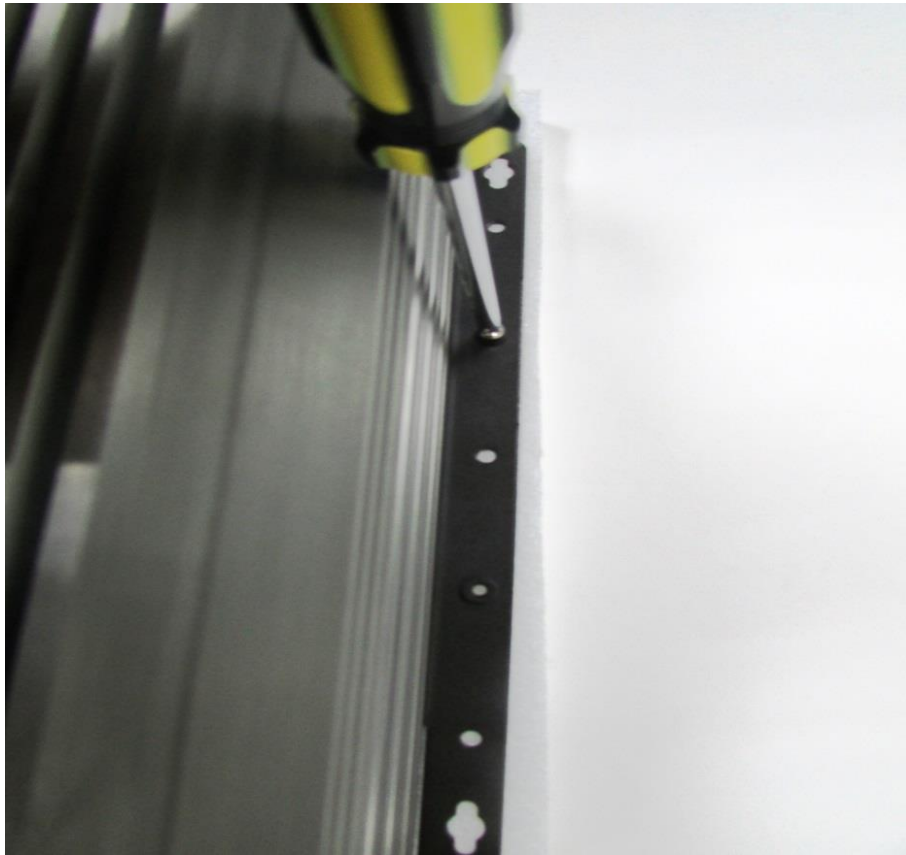

2. Fasten the screws through the mounting hole to mount system on the wall.





Chapter 4

BIOS Setup

4.1 BIOS Introduction

The BIOS (Basic Input/ Output System) is a program located on a Flash Memory on the motherboard. When you start the computer, the BIOS program will gain control. The BIOS first operates an auto-diagnostic test called POST (power on self-test) for all the necessary hardware, it detects the entire hardware device and configures the parameters of the hardware synchronization.

BIOS Setup

Power on the computer and by pressing immediately allows you to enter Setup. If the message disappears before your respond and you still wish to enter Setup, restart the system to try again by turning it OFF then ON or pressing <Ctrl>, <Alt> and <Delete> keys.

Control Keys	
<←> <→>	Move to select screen
<↑> <↓>	Move to select item
<Esc>	Quit the BIOS Setup
<Enter>	Select item
<Page Up/+>	Increases the numeric value or makes changes
<Page Down/->	Decreases the numeric value or makes changes
<Tab>	Select setup fields
<F1>	General help
<F2>	Previous value
<F3>	Load Optimized defaults
<F10>	Save configuration and Exit

Main Menu

The main menu lists the setup functions you can make changes to. You can use the arrow keys (↑↓) to select the item. The on-line description of the highlighted setup function is displayed at the bottom of the screen.

Sub-Menu

If you find a right pointer symbol appears to the left of certain fields that means a sub-menu can be launched from this field. A sub-menu contains additional options for a field parameter. You can use arrow keys (↑↓) to highlight the field and press <Enter> to call up the sub-menu. Then you can use the control keys to enter values and move from field to field within a sub-menu. If you want to return to the main menu, just press the <Esc >.

4.2 Main Setup

Press to enter BIOS CMOS Setup Utility, the Main Menu (as shown below) will appear on the screen. Use arrow keys to move among the items and press <Enter> to accept or enter a sub-menu.

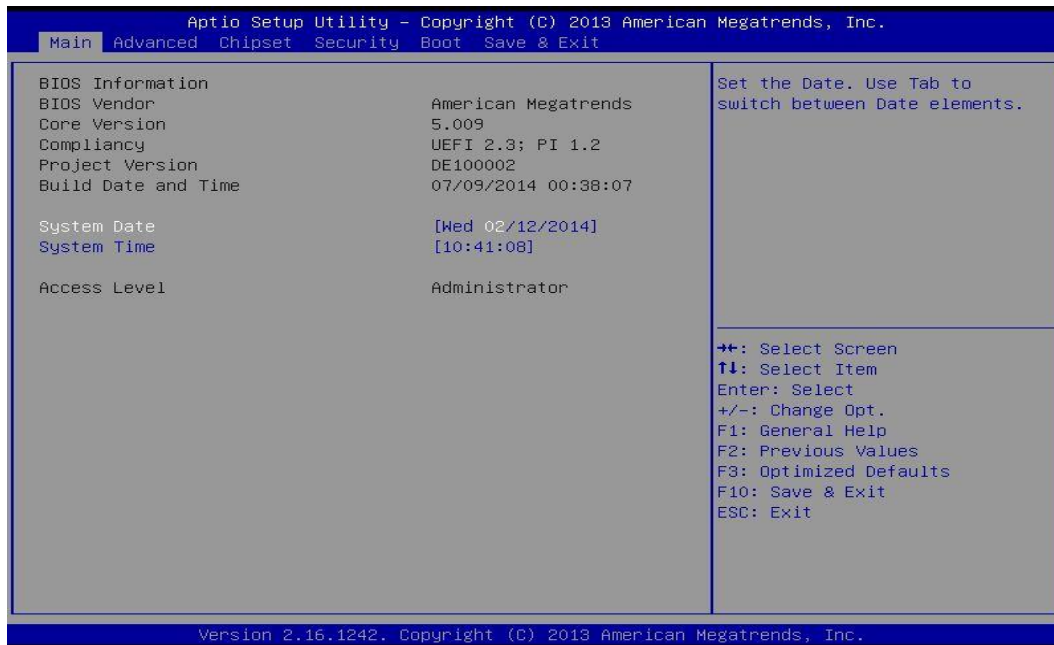

4.2.1 System Date

Set the date. Please use <Tab> to switch between date elements.

4.2.2 System Time

Set the time. Please use <Tab> to switch between time elements.

4.3 Advanced Setup

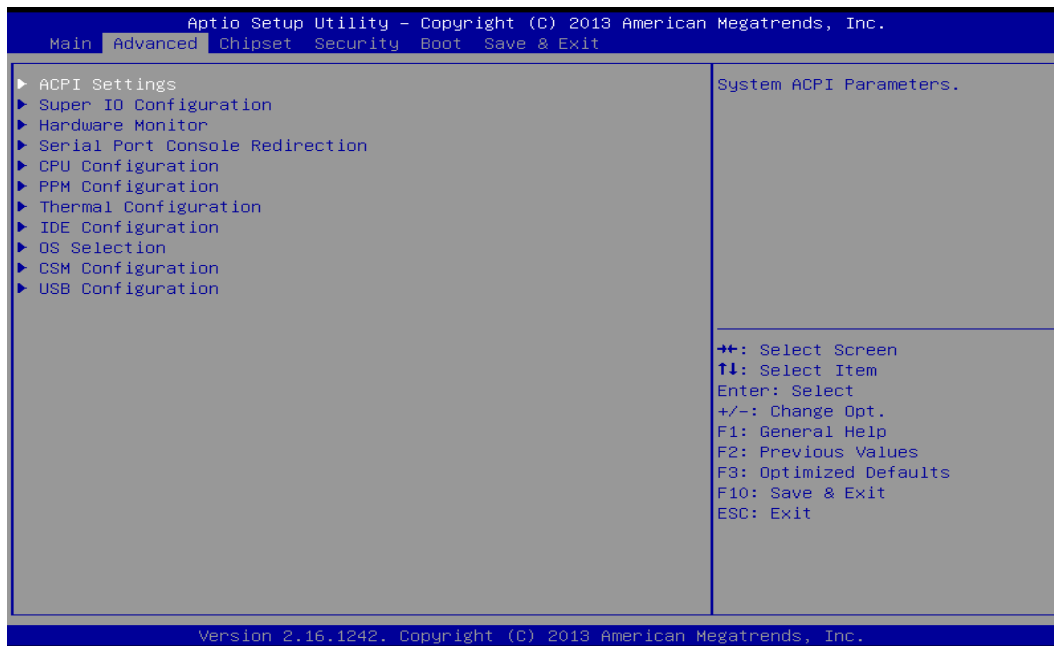

4.3.1 ACPI Setting

Enable or disable BIOS ACPI Auto Configuration.

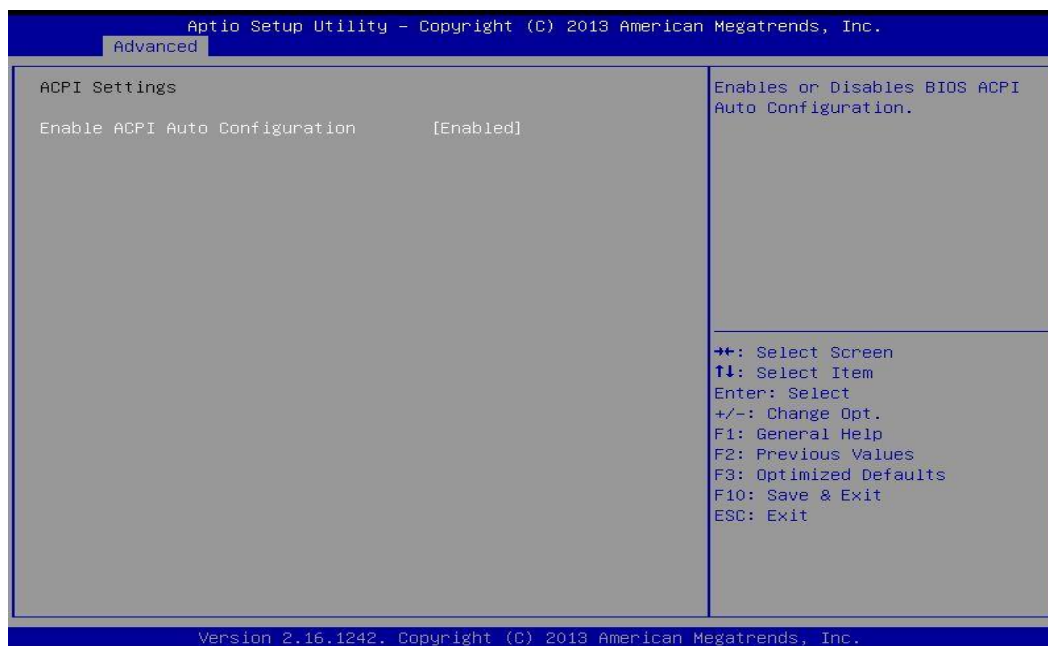

4.3.2 Super IO Configuration

You can use this screen to select options for the Super IO Configuration, and change the value of the selected option.

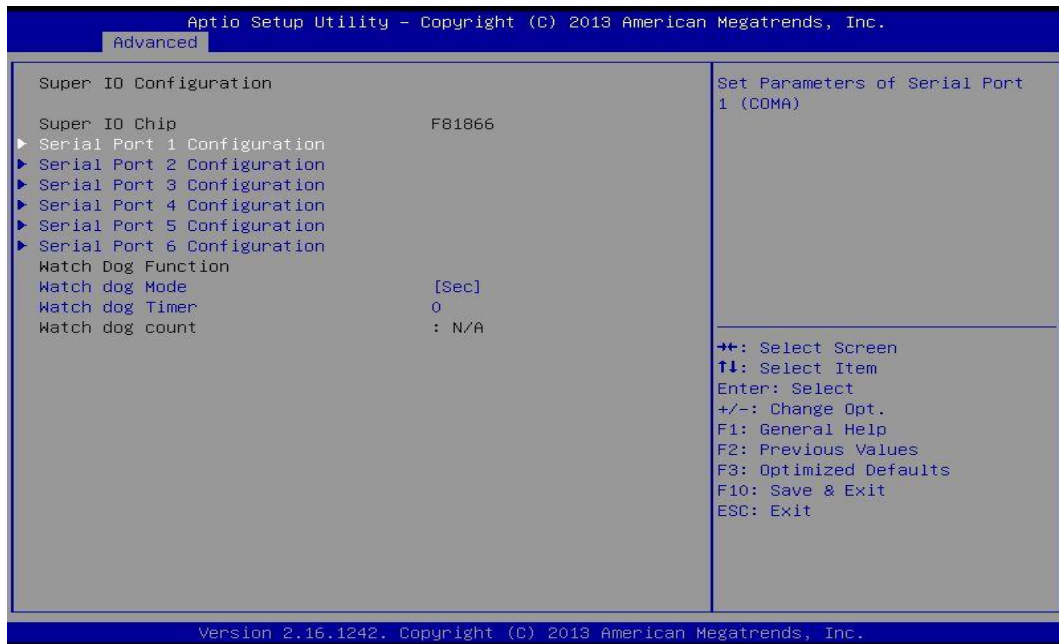

Serial Port 1~6 Configuration

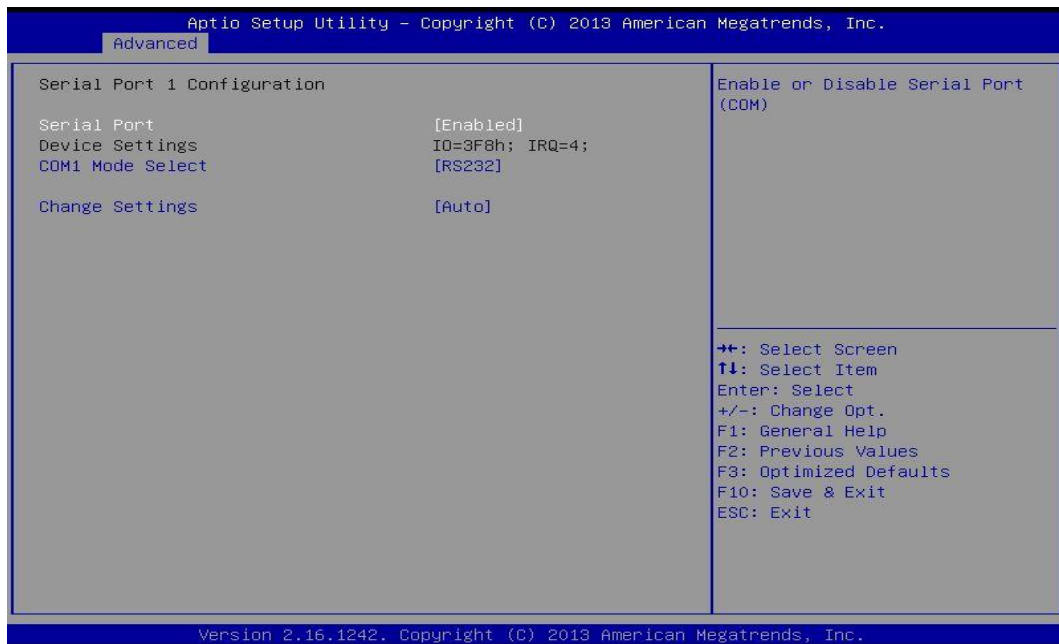

Serial Port

This item will allow users to enable or disable serial port.

COM Mode Select

Change the Serial interface. Select <RS232>, <RS422> or <RS485> interface.

Change Settings

This setting is used to change the address & IRQ settings of the specified serial port.

■ Watch Dog Mode

Changes the Watch dog mode. Select [Sec] or [Min] mode.

■ Watch Dog Timer

User can set a value in the range of 0 to 255.

4.3.3 Hardware Monitor

These items display the current status of all monitored hardware devices/ components such as voltages and temperatures.

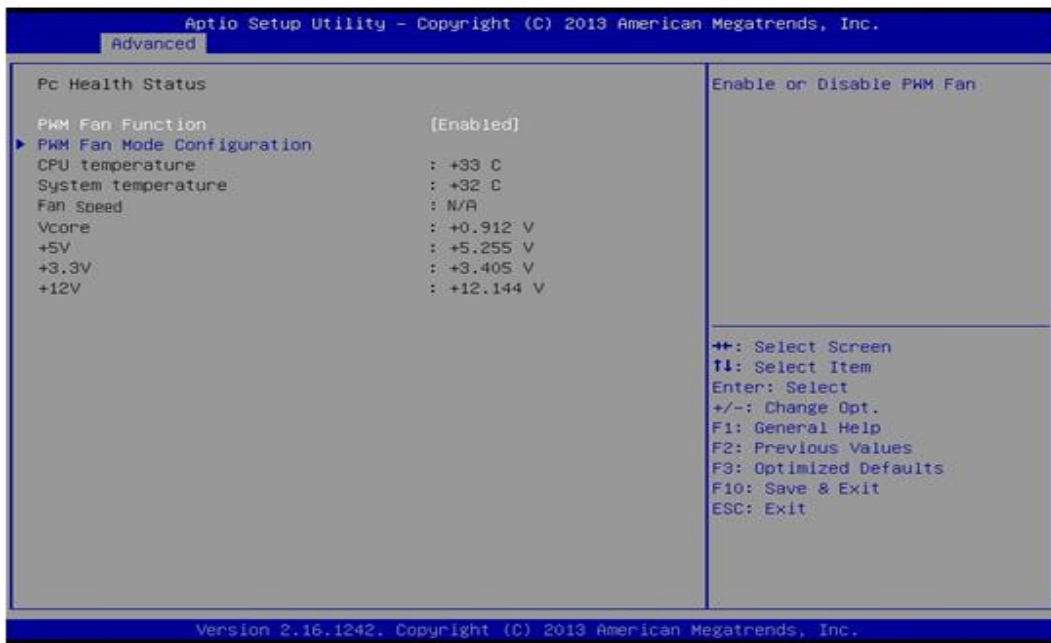

■ PWM Fan Function

This item will allow users to enable or disable PWM Fan.

■ PWM Fan Mode Configuration

PWM Fan Duty

This item allows users to change the PWM Fan duty.

4.3.4 Serial Port Console Redirection

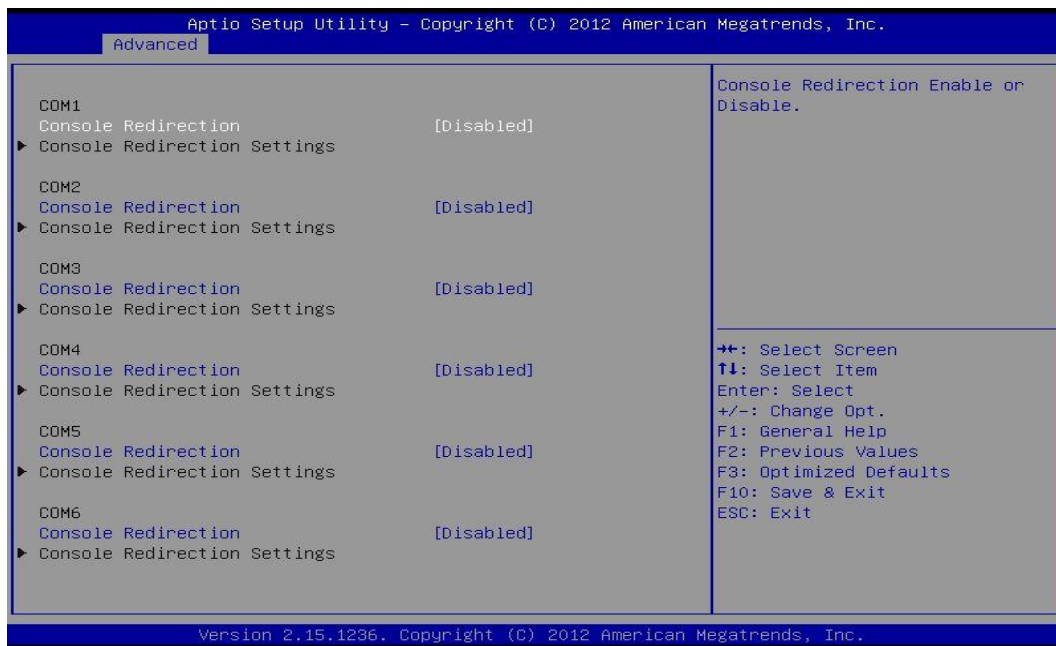

■ Console Redirection

These items allow users to enable or disable console redirection function.

4.3.5 CPU Configuration



■ Socket 0 CPU Information

This section provides information on your CPU, frequency, and cache memory.

■ Active Processor Cores

Change the active processor cores. Select <All> or <1> mode.

■ Limit CPUID Maximum

Allows user to determine whether to limit CPUID maximum value. Set this item to Disabled: For Windows XP operating system.

Enabled: For legacy operating system such as Windows NT4.0. (Default: Disabled)

■ Execute Disable Bit

Enables or disables Intel Execute Disable Bit function.

■ Hardware Prefetcher

Enables or disables L2 Cache Hardware Prefetcher.

■ Adjacent Cache Line Prefetch

Enables or disables L2 prefetching of adjacent cache lines.

■ Intel Virtualization Technology

Enables or disables Intel Virtualization Technology. Virtualization enhanced by Intel Virtualization Technology will allow a platform to run multiple operating systems and applications in independent partitions. With virtualization, one computer system can function as multiple virtual systems.

■ Power Technology

Allows user to configure Intel power management features.

4.3.6 PPM Configuration



■ EIST

Enable or disable Intel SpeedStep.

■ CPU C state Report

Enables or disables support for CPU's power-saving functions.

■ Enhanced C state

Enables or disables Intel CPU Enhanced Halt (C1E) function, a CPU power-saving function in system halt state. When enabled, the CPU core frequency and voltage will be reduced during system halt state to decrease power consumption. This item is configurable only when CPU C state Report is enabled.

■ Max CPU C-state

Allows user to determine the maximum C state that the CPU will support.

4.3.7 Thermal Configuration



■ Critical Trip Point

Allows user to set the CPU temperature threshold. If the CPU temperature reaches this value, the operating system will shut down the system. This item is configurable only when DTS is enabled.

■ Passive Trip Point

Allows user to set the CPU temperature threshold. If the CPU temperature reaches this value, the CPU frequency will be automatically reduced. This item is configurable only when DTS is enabled.

■ DTS

Enables or disables the CPU overheating protection function. (Default: Disabled)

4.3.8 IDE Configuration

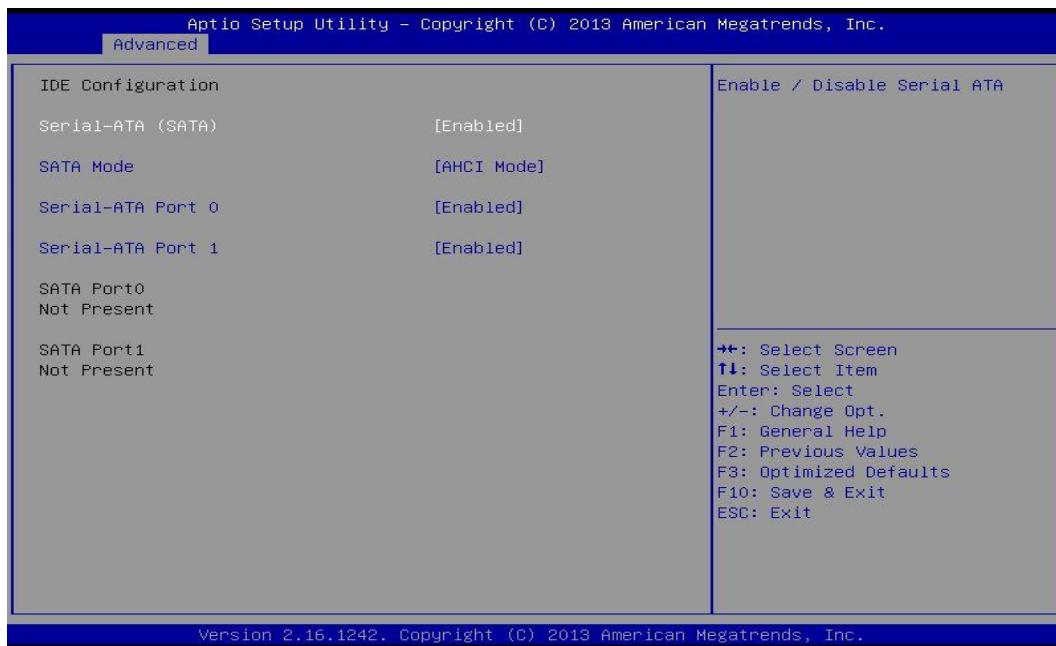

■ Serial-ATA (SATA)

This item will allow users to enable or disable Serial ATA.

■ SATA Mode

This item will allow users to select IDE or AHCI Mode.

■ Serial – ATA Port 0

This item will allow users to enable or disable Serial-ATA Port 0.

■ Serial – ATA Port 1

This item will allow users to enable or disable Serial-ATA Port 1.

4.3.9 OS Selection

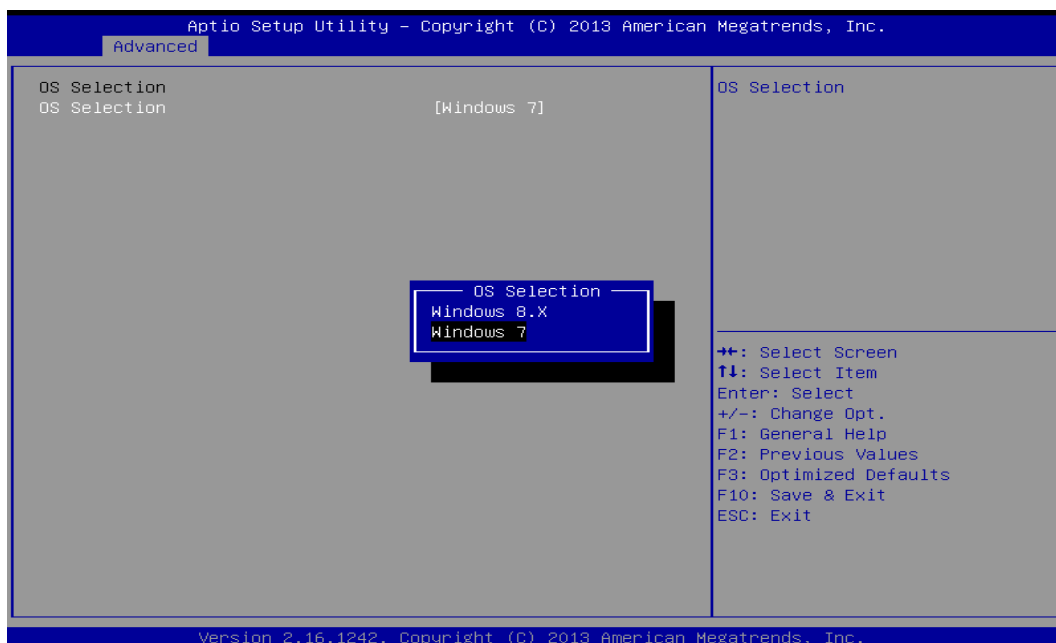

■ OS Selection

This item will allow users to select Windows 8.X or Windows 7 OS.

4.3.10 CSM (Compatibility Support Module) Configuration

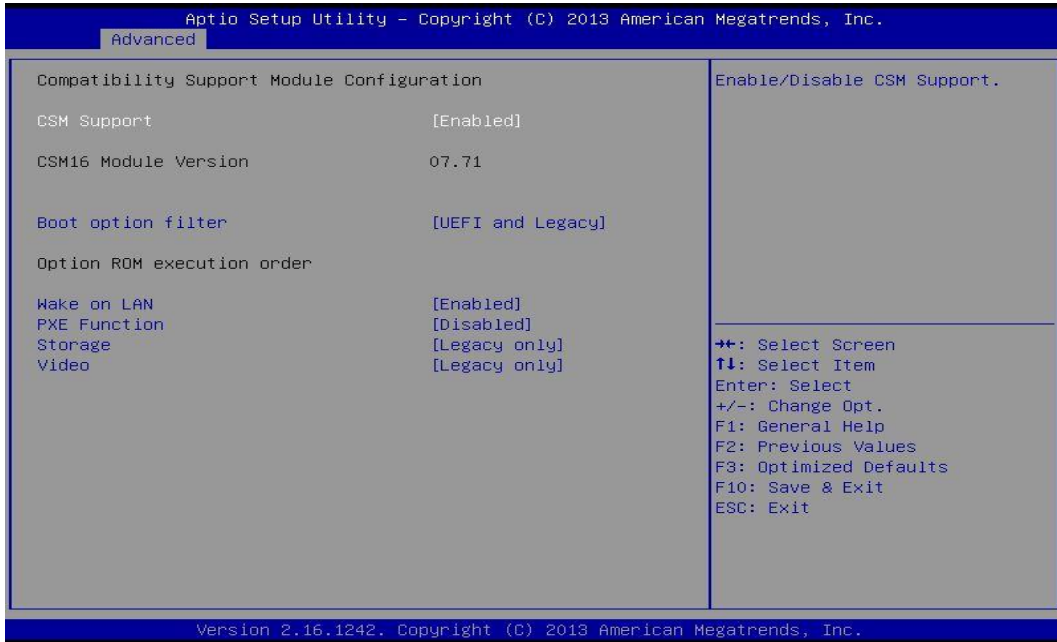

■ CSM Support

Enables or disables UEFI CSM (Compatibility Support Module) to support a legacy PC boot process.

■ Boot option filter

Allows user to select which type of operating system to boot.

UEFI and Legacy: Allows booting from operating systems that support legacy option ROM or UEFI option ROM.

Legacy only: Allows booting from operating systems that only support legacy option ROM.

UEFI only: Allows booting from operating systems that only support UEFI option ROM.

This item is configurable only when CSM Support is set to Enabled.

■ Wake on LAN

This item will allow users to enable or disable wake on LAN function.

■ PXE Function

This item will allow users to enable or disable PXE function.

■ Storage

Allows user to select whether to enable the UEFI or legacy option ROM for the storage device controller.

Do not launch: Disables option ROM.

UEFI only: Enables UEFI option ROM only.

Legacy only: Enables legacy option ROM only.

■ Video

Allows user to select whether to enable the UEFI or legacy option ROM for the storage device controller.

Do not launch: Disables option ROM.

UEFI only: Enables UEFI option ROM only.

Legacy only: Enables legacy option ROM only.

4.3.11 USB Configuration

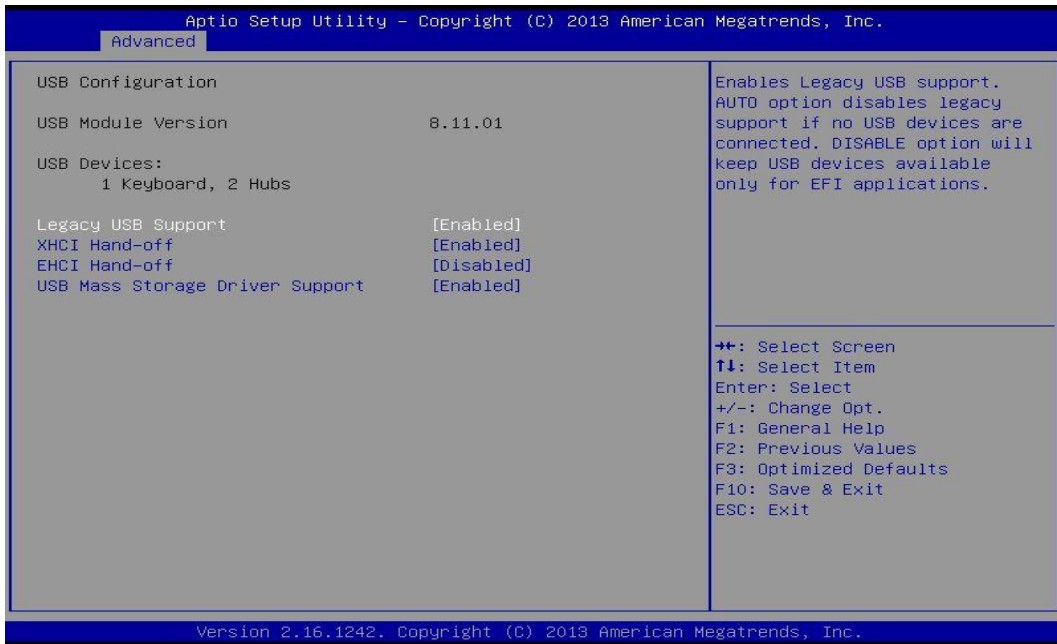

■ Legacy USB Support

Allows USB keyboard/ mouse to be used in MS-DOS.

■ XHCI Hand-off

Determines whether to enable XHCI (USB3.0) Hand-off feature for an operating system without XHCI (USB3.0) Hand-off support.

■ EHCI Hand-off

Determines whether to enable EHCI Hand-off feature for an operating system without EHCI Hand-off support.

■ USB Mass Storage Driver Support

Enables or disables support for USB storage devices.

4.4 Chipset Setup



4.4.1 North Bridge

This section provides information on the installed memory size and memory/onboard graphics-related configuration options.

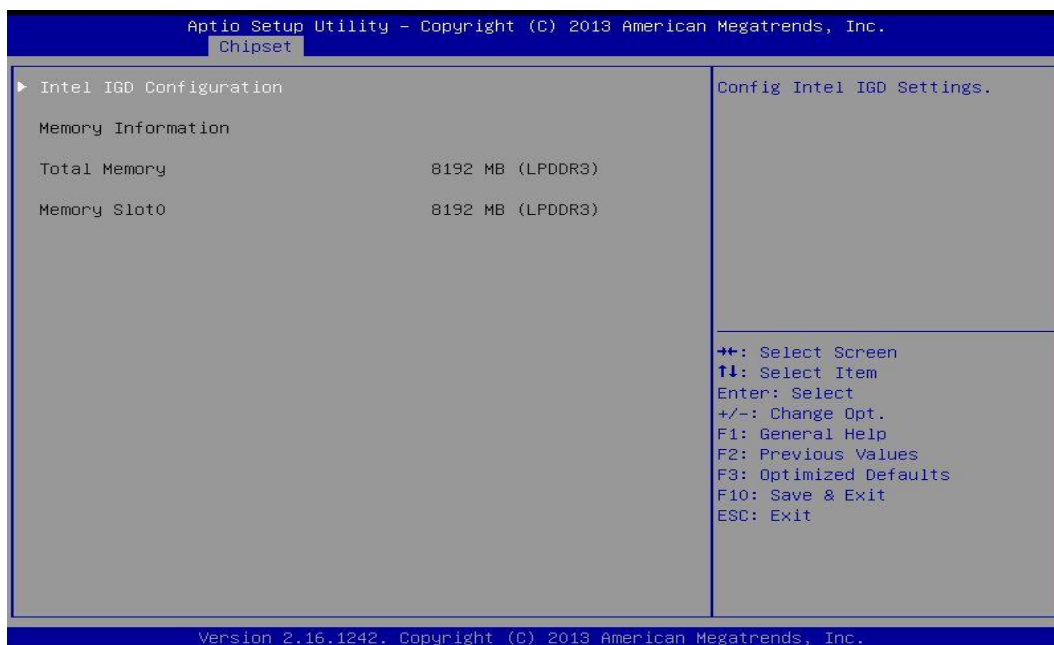

■ Intel IGD Configuration

This section provides onboard graphics-related configuration options



- GOP Driver**
This item will allow users to enable or disable GOP Driver.
- Integrated Graphics Device**
This item will allow users to enable or disable Integrated Graphics Device.
- IGD Turbo Enable**
This item will allow users to enable or disable IGD Turbo.
- Primary Display**
"Auto or IGFX or PEG or PCIE or SG" optimal to Primary Display.
- GFX Boost**
This item will allow users to enable or disable GFX Boost.
- Aperture Size**
Aperture size optimal between 128MB, 256MB, or 512MB.
- DOP CG**
This item will allow users to enable or disable DOP CG.
- GTT Size**
GTT size optimal between 1MB or 2MB.
- IGD Thermal**
This item will allow users to enable or disable IGD Thermal.

4.4.2 South Bridge

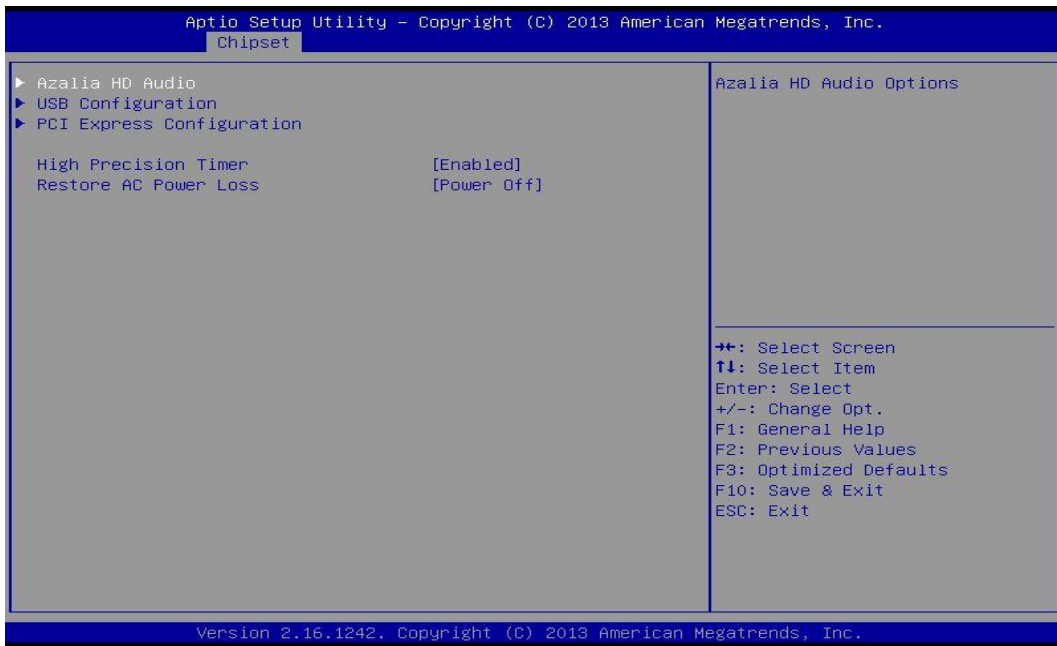

■ Azalia HD Audio

Control detection of the Azalia device.

Audio Controller

Enabled: Azalia will be unconditionally enabled.

Disabled: Azalia will be unconditionally disabled.

■ USB Configuration

XHCI Mode

This setting disables/enables the USB XHCI controller. The eXtensible Host Controller Interface (XHCI) is a computer interface specification that defines a register-level description of a Host Controller for Universal Serial Bus (USB), which is capable of interfacing to USB 1.0, 2.0, and 3.0 compatible devices. The specification is also referred to as the USB 3.0 Host Controller specification.

USB 2 Link Power Management

This setting disables/enables the USB 2 Link Power Management function.

USB 2.0 (EHCI) Support

This setting disables/enables the USB EHCI controller. The Enhanced Host Controller Interface (EHCI) specification describes the register-level interface for a Host Controller for the Universal Serial Bus (USB) Revision 2.0.

USB Port 0

This item will allow users to enable or disable USB Port 0.

USB Port 1

This item will allow users to enable or disable USB Port 1.

USB Port 2

This item will allow users to enable or disable USB Port 2.

USB Port 3

This item will allow users to enable or disable USB Port 3.

■ **PCI Express Configuration**

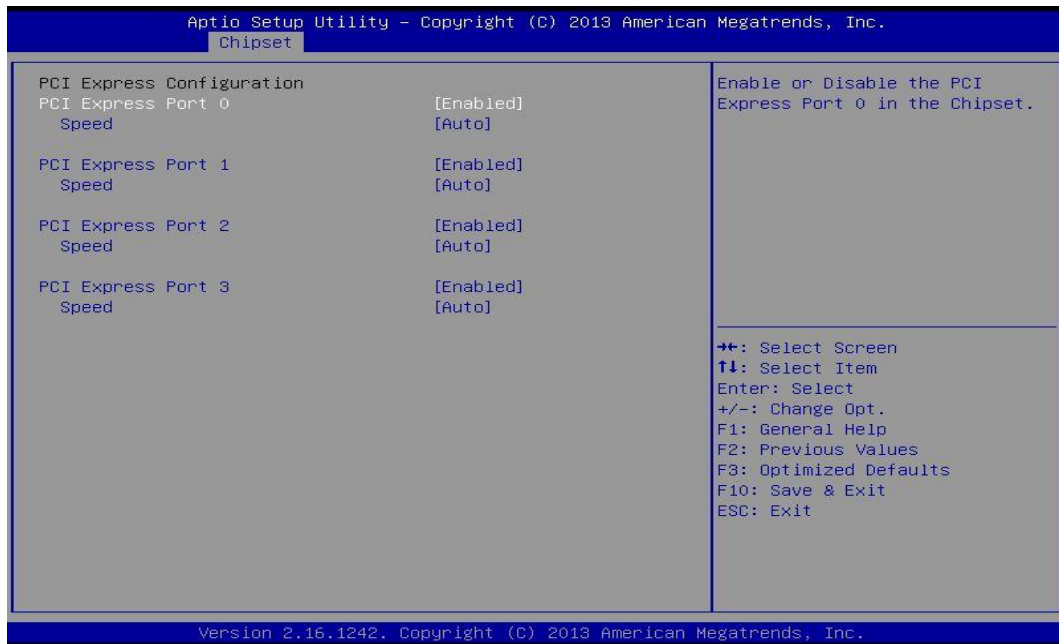

PCI Express Port 0

This item will allow users to enable or disable PCI Express Port 0.

Speed

Change the PCI Express interface speed. Select <AUTO> ,<Gen 2> or <Gen 1>

PCI Express Port 1

This item will allow users to enable or disable PCI Express Port 1.

Speed

Change the PCI Express interface speed. Select <AUTO> ,<Gen 2> or <Gen 1>

PCI Express Port 2

This item will allow users to enable or disable PCI Express Port 2.

Speed

Change the PCI Express interface speed. Select <AUTO> ,<Gen 2> or <Gen 1>

PCI Express Port 3

This item will allow users to enable or disable PCI Express Port 3.

Speed

Change the PCI Express interface speed. Select <AUTO> ,<Gen 2> or <Gen 1>

■ **High Precision Timer**

Enable or disable High Precision Event Timer (HPET) in the operating system.

■ **Restore AC Power Loss**

This setting specifies whether your system will reboot after a power failure or interrupt occurs. Available settings are:

Power Off: Leave the computer in the power off state.

Power On: Leave the computer in the power on state.

Last State: Restore the system to the previous status before power failure or interrupt occurred.

■ Mini-PCle/MSATA Select (CN4)

This item allows users to select Mini-PCIE or MSATA interface.

4.5 Security Setup

This section allows users to configure BIOS security settings.

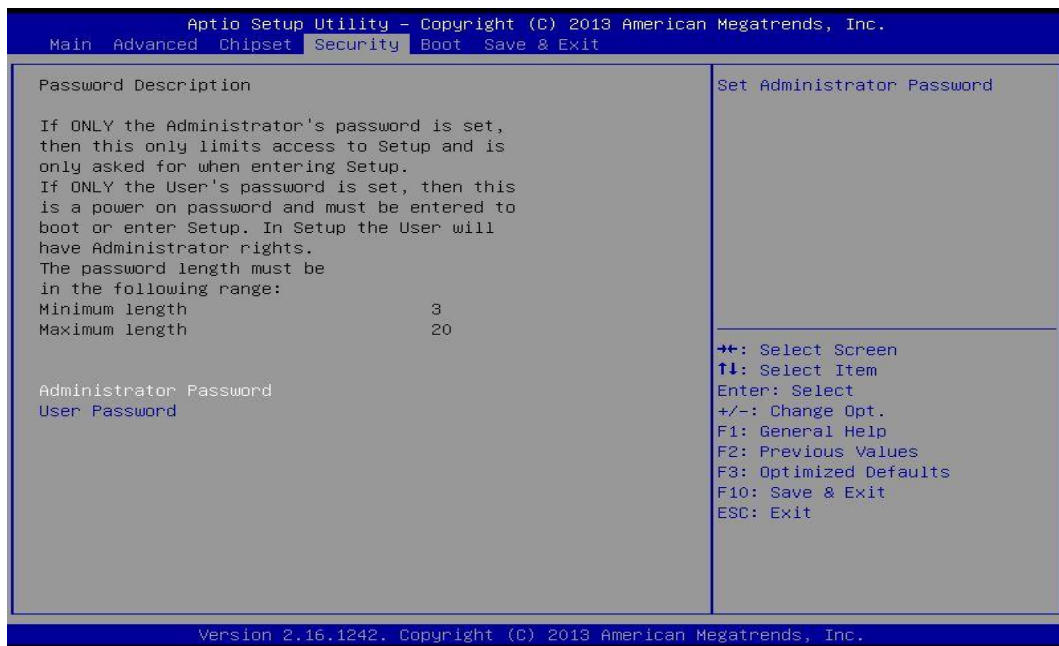

4.5.1 Administrator Password

Administrator Password controls access to the BIOS Setup utility.

4.5.2 User Password

User Password controls access to the system at boot and to the BIOS Setup utility.

4.6 Boot Setup

This section allows you to configure Boot settings.

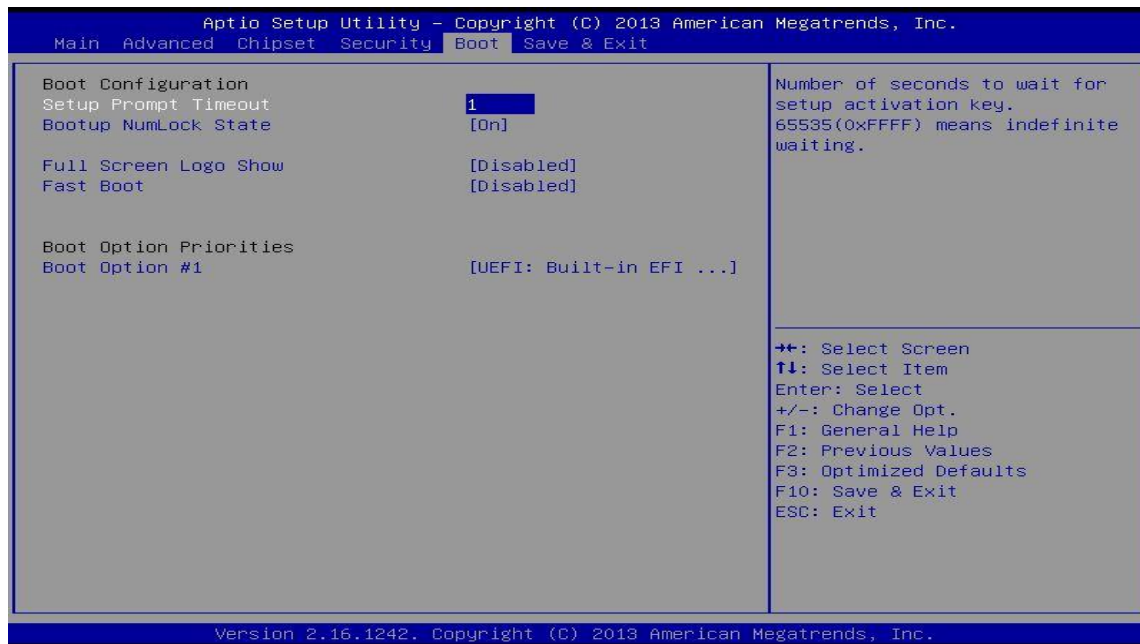

4.6.1 Setup Prompt Timeout

Use this item to set number of seconds to wait for setup activation key.

4.6.2 Bootup NumLock State

Select the Power-on state for Numlock.

4.6.3 Full Screen Logo Show

This item allows user to enable or disable full screen logo show.

4.6.4 Fast Boot

This item allows user to enable or disable Fast Boot option.

4.7 Save & Exit



4.7.1 Save Changes and Reset

This item allows user to reset system setup after saving changes.

4.7.2 Discard Changes and Reset

This item allows user to reset system setup without saving any changes.

4.7.3 Restore Defaults

This item allows user to restore/ load default values for all the options.

4.7.4 Save as User Defaults

This item allows user to save the changes done so far as user defaults.

4.7.5 Restore User Defaults

This item allows user to restore the user defaults to all the options.



Chapter 5

Product Application

5.1 Digital I/O (DIO) application

This section describes DIO application of the product. The content and application development are better understood and implemented by well experienced professionals or developers.

5.1.1 Digital I/O Programming Guide

5.1.1.1 Pins for Digital I/O for Cincoze DE series product

Item	Standard
GPIO74 (Pin107)	DI
GPIO75 (Pin108)	
GPIO76 (Pin109)	
GPIO77 (Pin110)	
GPIO80 (Pin111)	DO
GPIO81 (Pin112)	
GPIO82 (Pin113)	
GPIO83 (Pin114)	

5.1.1.2 Programming Guide

To program the Super I/O chip F81866A configuration registers, the following configuration procedures must be followed in sequence:

- (1) Enter the Extended Function Mode
- (2) Configure the configuration registers
- (3) Exit the Extended Function Mode

The configuration register is used to control the behavior of the corresponding devices. To configure the register, use the index port to select the index and then write data port to alter the parameters. The default index port and data port are 0x4E and 0x4F, respectively. **To enable configuration, the entry key 0x87 must be written to the index port. To disable configuration, write exit entry key 0xAA to the index port.** Following is an example to enable configuration and to disable configuration by using debug.

- o 4e 87
- o 4e 87 (enable configuration)
- o 4e aa (disable configuration)

5.1.1.3 Relative Registers

To program the F81866A configuration registers, see the following configuration procedures.

Logic Device Number Register (LDN) — Index 07h

Bit	Name	R/W	Reset	Default	Description
7-0	LDN	R/W	LRESET#	00h	00h: Select FDC device configuration registers. 03h: Select Parallel Port device configuration registers. 04h: Select Hardware Monitor device configuration registers. 05h: Select KBC device configuration registers. 06h: Select GPIO device configuration registers. 07h: Select WDT device configuration registers. 0Ah: Select PME, ACPI and ERP device configuration registers. 10h: Select UART1 device configuration registers. 11h: Select UART2 device configuration registers. 12h: Select UART3 device configuration registers. 13h: Select UART4 device configuration registers. 14h: Select UART5 device configuration registers. 15h: Select UART6 device configuration registers. Otherwise: Reserved.

7.7.11.1 GPIO7 Output Enable Register — Index 80h

Bit	Name	R/W	Reset	Default	Description
7	GPIO77_OE	R/W	LRESET#	0	0: GPIO77 is in input mode. 1: GPIO77 is in output mode.
6	GPIO76_OE	R/W	LRESET#	0	0: GPIO76 is in input mode. 1: GPIO75 is in output mode.
5	GPIO75_OE	R/W	LRESET#	0	0: GPIO75 is in input mode. 1: GPIO75 is in output mode.
4	GPIO74_OE	R/W	LRESET#	0	0: GPIO74 is in input mode. 1: GPIO74 is in output mode.

7.7.11.3 GPIO7 Pin Status Register — Index 82h (This byte could be also read by base address + 3)

Bit	Name	R/W	Reset	Default	Description
7	GPIO77_IN	R	-	-	The pin status of GPIO77/STB#.
6	GPIO76_IN	R	-	-	The pin status of GPIO76/AFD#.
5	GPIO75_IN	R	-	-	The pin status of GPIO75/ERR#.
4	GPIO74_IN	R	-	-	The pin status of GPIO74/INIT#.

7.7.12.1 GPIO8 Output Enable Register — Index 88h

3	GPIO83_OE	R/W	LRESET#	1	0: GPIO83 is in input mode. 1: GPIO83 is in output mode.
2	GPIO82_OE	R/W	LRESET#	1	0: GPIO82 is in input mode. 1: GPIO82 is in output mode.
1	GPIO81_OE	R/W	LRESET#	1	0: GPIO81 is in input mode. 1: GPIO81 is in output mode.
0	GPIO80_OE	R/W	LRESET#	1	0: GPIO80 is in input mode. 1: GPIO80 is in output mode.

7.7.12.2 GPIO8 Output Data Register — Index 89h (This byte could be also written by base address + 2)

3	GPIO83_VAL	R/W	LRESET#	1	0: GPIO83 outputs 0 when in output mode. 1: GPIO83 outputs 1 when in output mode.
2	GPIO82_VAL	R/W	LRESET#	1	0: GPIO82 outputs 0 when in output mode. 1: GPIO82 outputs 1 when in output mode.
1	GPIO81_VAL	R/W	LRESET#	1	0: GPIO81 outputs 0 when in output mode. 1: GPIO81 outputs 1 when in output mode.
0	GPIO80_VAL	R/W	LRESET#	1	0: GPIO80 outputs 0 when in output mode. 1: GPIO80 outputs 1 when in output mode.

5.1.1.4 Sample Code in C Language

5.1.1.4.1 Control of GP74 to GP77 (DI1 ~ DI4)

```
#define AddrPort 0x4E
```

```
#define DataPort 0x4F
```

<Enter the Extended Function Mode>

```
WriteByte(AddrPort, 0x87)
```

```
WriteByte(AddrPort, 0x87) // Must write twice to enter Extended mode
```

<Select Logic Device>

```
WriteByte(AddrPort, 0x07)
```

```
WriteByte(dataPort, 0x06) //Select logic device 06h
```

<Input Mode Selection> //Set GP74 to GP77 input Mode

```
WriteByte(AddrPort, 0x80) // Select configuration register 80h
```

```
WriteByte(DataPort, 0x0X) //Set (bit 4~7) = 0 to select GP 74~77 as Input mode.
```

<input Value>

```
WriteByte(AddrPort, 0x82) // Select configuration register 82h
```

```
ReadByte(DataPort, Value) // Read bit 4~7(0xFx)= GP74 ~77 as High.
```

<Leave the Extended Function Mode>

```
WriteByte(AddrPort, 0xAA)
```

5.1.1.4.2 Control of GP80 to GP83 (DO1 ~ DO4)

```
#define AddrPort 0x4E
```

```
#define DataPort 0x4F
```

<Enter the Extended Function Mode>

```
WriteByte(AddrPort, 0x87)
```

```
WriteByte(AddrPort, 0x87) // Must write twice to enter Extended mode
```

<Select Logic Device>

```
WriteByte(AddrPort, 0x07)
```

```
WriteByte(DataPort, 0x06) // Select logic device 06h
```

<Output/Input Mode Selection> // Set GP80 to GP83 output Mode

```
WriteByte(AddrPort, 0x88) // Select configuration register 88h
```

```
WriteByte(DataPort, 0xFF) // Set (bit 0~3) = 1 to select GP 80 ~83 as Output mode.
```

<Output Value>

```
WriteByte(AddrPort, 0x89) // Select configuration register 89h
```

```
WriteByte(DataPort, Value) // Set bit 0~3=(0/1) to output GP 80~83 as Low or High
```

<Leave the Extended Function Mode>

```
WriteByte(AddrPort, 0xAA)
```

5.1.1.5 Change base address - DIO base address (Cincoze default 0xA00)

<Enter the Extended Function Mode>

```
WriteByte(AddrPort, 0x87)
```

```
WriteByte(AddrPort, 0x87) // Must write twice to enter Extended mode
```

<Select Logic Device>

```
WriteByte(AddrPort, 0x07)
```

```
WriteByte(dataPort, 0x06) // Select logic device 06h
```

```
WriteByte(AddrPort, 0x60) // Select configuration register 60h (High Byte address)
```

```
WriteByte(DataPort, (0x0A))
```

```
WriteByte(AddrPort, 0x61) // Select configuration register 61h (Low Byte address)
```

```
WriteByte(DataPort, (0x00))
```

<Leave the Extended Function Mode>

```
WriteByte(AddrPort, 0xAA)
```

Cincoze DIO Port base address is 0xA00h

5.1.1.6 DATA Bit Table (DIO)

7	6	5	4	3	2	1	0	bit
0	0	0	1	-	-	-	-	value
1			X				/h	

= DI1
(Base Address +3)
(0xA03)

7	6	5	4	3	2	1	0	bit
-	-	-	-	0	0	0	1	value
X				1			/h	

= DO1
(Base Address +2)
(0xA02)

7	6	5	4	3	2	1	0	bit
0	0	1	0	-	-	-	-	value
2			X				/h	

= DI2
(Base Address +3)
(0xA03)

7	6	5	4	3	2	1	0	bit
-	-	-	-	0	0	1	0	value
X				2			/h	

= DO2
(Base Address +2)
(0xA02)

7	6	5	4	3	2	1	0	bit
0	1	0	0	-	-	-	-	value
4			X				/h	

= DI3
(Base Address +3)
(0xA03)

7	6	5	4	3	2	1	0	bit
-	-	-	-	0	1	0	0	value
X				4			/h	

= DO3
(Base Address +2)
(0xA02)

7	6	5	4	3	2	1	0	bit
1	0	0	0	-	-	-	-	value
8			X				/h	

= DI4
(Base Address +3)
(0xA03)

7	6	5	4	3	2	1	0	bit
-	-	-	-	1	0	0	0	value
X				8			/h	

= DO4
(Base Address +2)
(0xA02)

5.1.1.7 DIO I/O Port Address

DI4	DI3	DI2	DI1	DO4	DO3	DO2	DO1	Pin Definition
7	6	5	4	3	2	1	0	Data Bits
DI				DO				DIO
0xA03				0xA02				I/O Port address

5.2 DE-1000 DIO Hardware Specification

- XCOM+: Isolated power in V+
- XCOM-: Isolated power in V-
- Isolated power in DC voltage: 9-30V
- 8x Digital Input (Source Type)
- Input Signal Voltage Level
 - Signal Logic 0: XCOM+ = 9V, $\text{Signal Low} - V_- < 1V$
XCOM+ > 9V, $V_+ - \text{Signal Low} > 8V$
 - Signal Logic 1: $> \text{XCOM+} - 3V$
- Input Driving Sink Current:
 - Minimal: 1 mA
 - Normal: 5 mA
- 8x Digital Output (Open Drain)
 - DO Signal have to pull up resistor to XCOM+ for external device, the resistance will affect the pull up current
 - Signal High Level: Pull up resistor to XCOM+
 - Signal Low Level: = XCOM-
 - Sink Current: 1A (Max)

cincoze

© 2020 Cincoze Co., Ltd. All rights reserved.

The Cincoze logo is a registered trademark of Cincoze Co., Ltd.

All other logos appearing in this catalog are the intellectual property of the respective company, product, or organization associated with the logo.

All product specifications and information are subject to change without notice.