

***chcoze***

# DS-1100 Series

## User Manual



### **Rugged Workstation**

7/6th Generation Intel® Core™ i3 / i5 / i7 (Kaby Lake-S/ Skylake-S)  
High Performance, Modular and Expandable Rugged Embedded  
Computer

Version: V2.42

# Contents

## Preface

|                                       |    |
|---------------------------------------|----|
| Revision.....                         | 05 |
| Copyright Notice.....                 | 05 |
| Acknowledgement.....                  | 05 |
| Disclaimer.....                       | 05 |
| Declaration of Conformity.....        | 05 |
| Product Warranty Statement .....      | 06 |
| Technical Support and Assistance..... | 07 |
| Conventions Used in this Manual ..... | 08 |
| Safety Precaution .....               | 08 |
| Package Contents .....                | 10 |
| Ordering Information .....            | 10 |

## Chapter 1 Product Introductions

|                                  |    |
|----------------------------------|----|
| 1.1 Overview .....               | 12 |
| 1.2 Highlights .....             | 12 |
| 1.3 Product Pictures.....        | 13 |
| 1.4 Key Features .....           | 13 |
| 1.5 Hardware Specification ..... | 14 |
| 1.6 System I/O .....             | 15 |
| 1.6.1 Front .....                | 15 |
| 1.6.2 Rear .....                 | 17 |
| 1.7 Mechanical Dimension .....   | 19 |

## Chapter 2 Switches and Connectors

|   |    |
|---|----|
| 2.1 Location of Switches and Connectors ..... | 22 |
| 2.1.1 Top View .....                          | 22 |
| 2.1.2 Bottom View .....                       | 23 |
| 2.2 Switches and Connectors Definition.....   | 24 |
| 2.3 Definition of Switches.....               | 25 |
| 2.4 Definition of Connectors .....            | 26 |

## Chapter 3 System Setup

|   |    |
|---|----|
| 3.1 Removing the Top Cover .....                          | 37 |
| 3.2 Installing CPU .....                                  | 40 |
| 3.3 Installing SO-DIMM Memory.....                        | 43 |
| 3.4 Installing a Mini-PCIe/mSATA Card on Top Side.....    | 46 |
| 3.5 Installing a Mini-PCIe/mSATA Card on Bottom Side..... | 48 |
| 3.6 Installing Antennas.....                              | 49 |

|  |    |
|--|----|
| 3.7 Installing a SATA Hard Drive on Top Side.....                          | 51 |
| 3.8 Installing a Low Speed CMI Module.....                                 | 53 |
| 3.9 Installing a High Speed CMI Module.....                                | 56 |
| 3.10 Installing a CFM-IGN Power Ignition Module.....                       | 61 |
| 3.11 Installing the Internal FAN (For DS-1102 only).....                   | 62 |
| 3.12 Installing a PCI/PCIe Add-on Card (For DS-1101 and DS-1102 only)..... | 63 |
| 3.13 Assembling the System.....  | 67 |
| 3.14 Installing a SATA Hard Drive at Front Side.....                       | 70 |
| 3.15 Installing a SIM Card.....  | 72 |
| 3.16 Installing the CMOS Battery.....                                      | 74 |
| 3.17 Fastening the Cover.....  | 76 |
| 3.18 Installing an External Fan.....                                       | 76 |
| 3.19 Wall Mount Brackets.....  | 79 |

## Chapter 4 BIOS Setup

|   |    |
|---|----|
| 4.1 BIOS Introduction .....                 | 82 |
| 4.2 Main Setup .....                        | 83 |
| 4.2.1 System Date .....                     | 83 |
| 4.2.2 System Time .....                     | 83 |
| 4.3 Advanced Setup .....                    | 83 |
| 4.3.1 ACPI Settings .....                   | 83 |
| 4.3.2 AMT Configuration.....                | 85 |
| 4.3.3 PCH-FW Configuration.....             | 86 |
| 4.3.4 F81866 Super IO Configuration.....    | 86 |
| 4.3.5 Hardware Monitor.....                 | 88 |
| 4.3.6 S5 RTC Wake Settings.....             | 88 |
| 4.3.7 Serial Port Console Redirection.....  | 89 |
| 4.3.8 CPU Configuration.....                | 89 |
| 4.3.9 SATA Configuration.....               | 90 |
| 4.3.10 PCI Subsystem Settings .....         | 92 |
| 4.3.11 CSM Configuration.....               | 94 |
| 4.3.12 USB Configuration.....               | 95 |
| 4.4 Chipset Setup .....                     | 96 |
| 4.4.1 System Agent (SA) Configuration ..... | 96 |
| 4.4.2 PCH-IO Configuration .....            | 97 |
| 4.5 Security Setup .....                    | 99 |
| 4.5.1 Administrator Password .....          | 99 |
| 4.5.2 User Password .....                   | 99 |
| 4.5.3 Security Boot.....                    | 99 |

|       |                                |     |
|-------|--------------------------------|-----|
| 4.6   | Boot Setup .....               | 100 |
| 4.6.1 | Setup Prompt Timeout.....      | 100 |
| 4.6.2 | Bootup NumLock State.....      | 100 |
| 4.6.3 | Quiet Boot .....               | 100 |
| 4.6.4 | Fast Boot .....                | 100 |
| 4.7   | Save & Exit .....              | 101 |
| 4.7.1 | Save Changes and Exit .....    | 101 |
| 4.7.2 | Discard Changes and Exit ..... | 101 |
| 4.7.3 | Save Changes and Reset .....   | 101 |
| 4.7.4 | Discard Changes and Reset..... | 101 |
| 4.7.5 | Save Changes .....             | 101 |
| 4.7.6 | Discard Changes .....          | 101 |
| 4.7.7 | Restore Defaults .....         | 101 |
| 4.7.8 | Save as User Defaults .....    | 101 |
| 4.7.9 | Restore User Defaults .....    | 101 |

## **Chapter 5 Product Application (For DIO Only)**

|       |  |     |
|-------|--|-----|
| 5.1   | Digital I/O (DIO) application .....            | 103 |
| 5.1.1 | Digital I/O Programming Guide .....            | 103 |
| 5.2   | Digital I/O (DIO) Hardware Specification ..... | 108 |
| 5.2.1 | CMI-CD, CMI-ICD Connector Definition.....      | 109 |

# Preface

## Revision

| Revision | Description  | Date       |
|----------|--|------------|
| 1.00     | New Release  | 2016/11/18 |
| 2.00     | Advancing DS-1100 Series to Revision R20               | 2018/9/17  |
| 2.10     | Correction Made  | 2018/11/20 |
| 2.20     | Correction Made  | 2019/08/13 |
| 2.30     | Update the Supporting Capacity of Memory to the latest | 2019/11/08 |
| 2.31     | Correction Made  | 2019/11/21 |
| 2.32     | Correction Made  | 2020/04/09 |
| 2.33     | New Format Updated                                     | 2020/10/07 |
| 2.34     | Correction Made  | 2020/11/13 |
| 2.35     | Correction Made  | 2021/01/26 |
| 2.36     | LVD Number Updated                                     | 2021/02/20 |
| 2.37     | Add DC_IN1 Warning                                     | 2021/04/20 |
| 2.38     | Correction Made  | 2021/06/28 |
| 2.39     | Add CMI-XM12LAN01-R10 installation steps               | 2021/07/26 |
| 2.40     | Correction Made  | 2021/08/10 |
| 2.41     | Correction Made  | 2022/05/31 |
| 2.42     | Correction Made  | 2023/04/14 |

## Copyright Notice

© 2016 by Cincoze Co., Ltd. All rights are reserved. No parts of this manual may be copied, modified, or reproduced in any form or by any means for commercial use without the prior written permission of Cincoze Co., Ltd. All information and specification provided in this manual are for reference only and remain subject to change without prior notice.

## Acknowledgement

Cincoze is a registered trademark of Cincoze Co., Ltd. All registered trademarks and product names mentioned herein are used for identification purposes only and may be trademarks and/or registered trademarks of their respective owners.

## Disclaimer

This manual is intended to be used as a practical and informative guide only and is subject to change without notice. It does not represent a commitment on the part of Cincoze. This product might include unintentional technical or typographical errors. Changes are periodically made to the information herein to correct such errors, and these changes are incorporated into new editions of the publication.

## Declaration of Conformity



### FCC

This equipment has been tested and found to comply with the limits for a Class A digital device, pursuant to Part 15 of the FCC Rules. These limits are designed to provide reasonable protection against harmful interference when the equipment is operated in a commercial environment. This equipment generates, uses, and can radiate radio frequency energy and, if not installed and used in accordance with the instruction manual, may cause harmful interference to radio communications. Operation of this equipment in a residential area is likely to cause harmful interference in which case the user will be required to correct the interference at his own expense.



### CE

The product(s) described in this manual complies with all application European Union (CE) directives if it has a CE marking. For computer systems to remain CE compliant, only CE-compliant parts may be used. Maintaining CE compliance also requires proper cable and cabling techniques.



### E-Mark

The "E" mark is based on ECE regulations issued by the Economic Commission for Europe. It is an organizational part of the UN and the members are EU countries and many others. Therefore, the acceptance of approved components is much broader, especially in the eastern part of Europe. It is necessary to confirm whether a particular country has accepted (signed) the application of an ECE-regulation; as the application it is not mandatory for the countries.

## Product Warranty Statement

### Warranty

Cincoze products are warranted by Cincoze Co., Ltd. to be free from defect in materials and workmanship for 2 years from the date of purchase by the original purchaser. During the warranty period, we shall, at our option, either repair or replace any product that proves to be defective under normal operation. Defects, malfunctions, or failures of the warranted product caused by damage resulting from natural disasters (such as by lightning, flood, earthquake, etc.), environmental and atmospheric disturbances, other external forces such as power line disturbances, plugging the board in under power, or incorrect cabling, and damage caused by misuse, abuse, and unauthorized alteration or repair, and the product in question is either software, or an expendable item (such as a fuse, battery, etc.), are not warranted.

### RMA

Before sending your product in, you will need to fill in Cincoze RMA Request Form and

obtain a RMA number from us. Our staff is available at any time to provide you with the most friendly and immediate service.

#### ■ **RMA Instruction**

- Customers must fill in Cincoze Return Merchandise Authorization (RMA) Request Form and obtain a RMA number prior to returning a defective product to Cincoze for service.
- Customers must collect all the information about the problems encountered and note anything abnormal and describe the problems on the “Cincoze Service Form” for the RMA number apply process.
- Charges may be incurred for certain repairs. Cincoze will charge for repairs to products whose warranty period has expired. Cincoze will also charge for repairs to products if the damage resulted from acts of God, environmental or atmospheric disturbances, or other external forces through misuse, abuse, or unauthorized alteration or repair. If charges will be incurred for a repair, Cincoze lists all charges, and will wait for customer’s approval before performing the repair.
- Customers agree to insure the product or assume the risk of loss or damage during transit, to prepay shipping charges, and to use the original shipping container or equivalent.
- Customers can be sent back the faulty products with or without accessories (manuals, cable, etc.) and any components from the system. If the components were suspected as part of the problems, please note clearly which components are included. Otherwise, Cincoze is not responsible for the devices/parts.
- Repaired items will be shipped along with a "Repair Report" detailing the findings and actions taken.

#### **Limitation of Liability**

Cincoze’ liability arising out of the manufacture, sale, or supplying of the product and its use, whether based on warranty, contract, negligence, product liability, or otherwise, shall not exceed the original selling price of the product. The remedies provided herein are the customer’s sole and exclusive remedies. In no event shall Cincoze be liable for direct, indirect, special or consequential damages whether based on contract of any other legal theory.

#### **Technical Support and Assistance**

1. Visit the Cincoze website at [www.cincoze.com](http://www.cincoze.com) where you can find the latest information about the product.
2. Contact your distributor or our technical support team or sales representative for technical support if you need additional assistance. Please have following information ready before you call:

- Product name and serial number
- Description of your peripheral attachments
- Description of your software (operating system, version, application software, etc.)
- A complete description of the problem
- The exact wording of any error messages

## Conventions Used in this Manual



**WARNING**

This indication alerts operators to an operation that, if not strictly observed, may result in severe injury.



**CAUTION**

This indication alerts operators to an operation that, if not strictly observed, may result in safety hazards to personnel or damage to equipment.



**NOTE**

This indication provides additional information to complete a task easily.

## Safety Precautions

Before installing and using this device, please note the following precautions.

1. Read these safety instructions carefully.
2. Keep this User's Manual for future reference.
3. Disconnect this equipment from any AC outlet before cleaning.
4. For plug-in equipment, the power outlet socket must be located near the equipment and must be easily accessible.
5. Keep this equipment away from humidity.
6. Put this equipment on a reliable surface during installation. Dropping it or letting it fall may cause damage.
7. Make sure the voltage of the power source is correct before connecting the equipment to the power outlet.
8. Use a power cord that has been approved for using with the product and that it matches the voltage and current marked on the product's electrical range label. The voltage and current rating of the cord must be greater than the voltage and current rating marked on the product.
9. Position the power cord so that people cannot step on it. Do not place anything over the power cord.



10. All cautions and warnings on the equipment should be noted.
11. If the equipment is not used for a long time, disconnect it from the power source to avoid damage by transient overvoltage.
12. Never pour any liquid into an opening. This may cause fire or electrical shock.
13. Never open the equipment. For safety reasons, the equipment should be opened only by qualified service personnel.

If one of the following situations arises, get the equipment checked by service personnel:

- The power cord or plug is damaged.
  - Liquid has penetrated into the equipment.
  - The equipment has been exposed to moisture.
  - The equipment does not work well, or you cannot get it work according to the user's manual.
  - The equipment has been dropped and damaged.
  - The equipment has obvious signs of breakage.
14. **CAUTION:** Danger of explosion if battery is incorrectly replaced. Replace only with the same or equivalent type recommended by the manufacturer.
  15. Equipment intended only for use in a RESTRICTED ACCESS AREA.

## Package Contents



Before installation, please ensure all the items listed in the following table are included in the package.

| Item | Description                                  | Q'ty |
|------|--|------|
| 1    | Embedded System                              | 1    |
| 2    | Heat Sink Pack                               | 1    |
| 3    | Screw Pack                                   | 1    |
| 4    | Wall Mounting Kit                            | 1    |
| 5    | Power Terminal Block Connector               | 1    |
| 6    | Remote Power On/Off Terminal Block Connector | 2    |
| 7    | Fan Terminal Block Connector                 | 1    |
| 8    | DVI-I to VGA Adaptor                         | 1    |

Note: Notify your sales representative if any of the above items are missing or damaged.

## Ordering Information

| Model No.   | Product Description   |
|-------------|---|
| DS-1100-R20 | 7/6th Generation Intel Core Series Processors,<br>High Performance, Expandable and Modular Rugged Embedded<br>Computer                                  |
| DS-1101-R20 | 7/6th Generation Intel Core Series Processors,<br>High Performance, Expandable and Modular Rugged Embedded<br>Computer with 1x PCI/PCIe Expansion Slot  |
| DS-1102-R20 | 7/6th Generation Intel Core Series Processors,<br>High Performance, Expandable and Modular Rugged Embedded<br>Computer with 2x PCI/PCIe Expansion Slots |



# **Chapter 1**

## **Product Introductions**

# 1.1 Overview

Cincoze DS-1100 Series is a high-performance fanless embedded computer powered by 7/6th generation Intel® Core™ platform supporting a wide range of desktop CPUs (socket-type, LGA1151), and accommodates two DDR4 sockets up to 32 GB which allows DS-1100 Series to fulfill all kinds of high-end computing requirements. DS-1100 Series provides powerful functionalities such as rich I/Os, Power over Serial, Electrical Isolated Serial Ports, Optical Isolated Digital I/O, multiple LAN, Power over Ethernet, M12 connectors, RAID 0/1, Power Ignition Sensing and Instant Reboot. Thanks to Cincoze's CMI & CFM Technology, it allows you to configure DS-1100 Series according to your specific needs with ready-to-use modules. DS-1100 Series also supports maximum 2 PCI/PCIe expansion slots with different combination of interfaces for expanding all kinds of application add-on cards. DS-1100 Series is truly a rugged computing system with features of wide operating temperature (-40°C to 70°C), wide range DC power input (from 9V to 48V), high tolerance of shock and vibration, high-standard industrial protections and the integrated SuperCap for battery-free operation. DS-1100 Series is suitable to deploy in a harsh environment and for critical applications, and it is totally maintenance-free.

# 1.2 Highlights

## High Performance

- Supports Intel® 7/6th Generation Processors (65W/35W)
- Performance Enhanced by Intel® 14 nm Technology
- Intel® HD Graphics Supports Triple Independent Display Resolution Up to 4K
- Intel® Q170 Chipset Brings More High-speed I/Os



## Powerful Functionalities

- Rich I/Os
- Multiple LAN
- Power over Serial
- Power over Ethernet
- Electrical Isolated Serial Port
- RAID 0/1
- Optical Isolated Digital I/O
- Instant Reboot
- Power Ignition Sensing
- M12 Connectors



## Fully Modular and Expandable

- CMI (Combined Multiple I/O) Technology for I/O expansion
- CFM (Control Function Module) Technology for Adding Power Ignition Sensing Function
- Mini-PCIe Modules and Dedicated I/O Brackets Are Available
- PCI/PCIe Slot with Different Combination of Interfaces



## 1.3 Product pictures

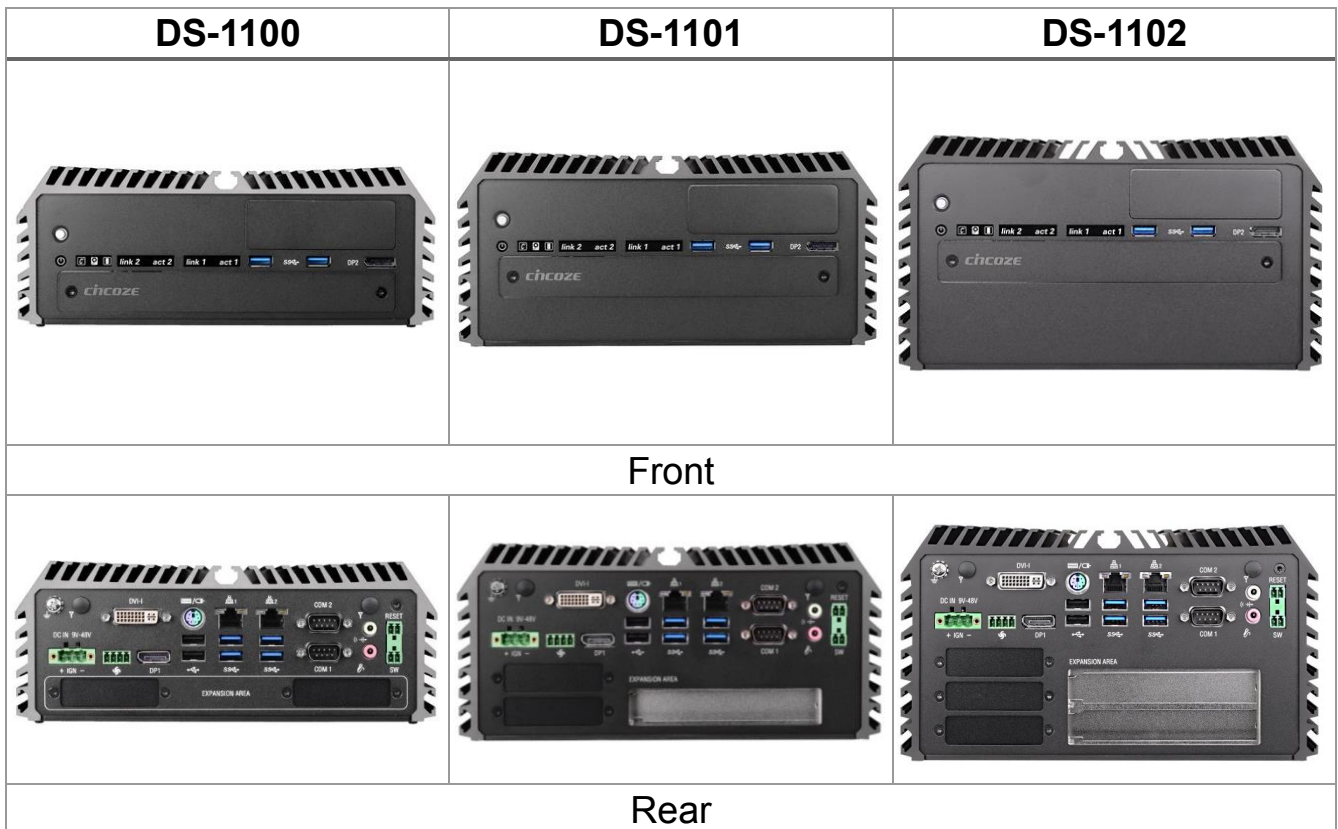

## 1.4 Key Features

- Supports Intel® 7/6th-Gen Intel® Core™ i3 / i5 / i7 Socket-type CPU (LGA1151)
- 2x DDR4 SO-DIMM Socket, 2,133MHz, Supports Up to 32 GB
- Triple Independent Display (1x DVI-I, 2x DP)
- 2x 2.5" SATA HDD/SSD bay (Gen3), Supports RAID 0/1
- PCI/PCIe Slot with Different Combination of Interfaces (For DS-1101 & DS-1102 only)
- 2x CMI Interfaces with 6 Types of Optional Modules for I/O Expansion
- 1x CFM Interface for Adding Optional Power Ignition Sensing (IGN) Module
- Supports 3x Full-size Mini-PCIe Slot for Wireless & I/O Expansion
- Wide Operating Temperature (-40°C to 70°C)
- EN50155 / EN50121-3-2 Certified for Railway Application
- E-Mark (E13, No.10R-0514229) Certified
- Safety: LVD EN62368-1

# 1.5 Hardware Specification

## Processor

- 7th Generation Intel® CPU (Kaby Lake-S)
  - Intel® Core™ i7-7700T Processor (8M Cache, up to 3.80 GHz, 35W TDP)
  - Intel® Core™ i5-7500T Processor (6M Cache, up to 3.30 GHz, 35W TDP)
  - Intel® Core™ i3-7101TE Processor (3M Cache, 3.40 GHz, 35W TDP)
  - Intel® Celeron® G3930TE Processor (2M Cache, 2.70 GHz, 35W TDP)
  - Intel® Core™ i7-7700 Processor (8M Cache, up to 4.20 GHz, 65W TDP)
  - Intel® Core™ i5-7500 Processor (6M Cache, up to 3.80 GHz, 65W TDP)
  - Intel® Celeron® G3930E Processor (2M Cache, 2.90 GHz, 54W TDP)
- 6th Generation Intel® CPU (Skylake-S)
  - Intel® Core™ i7-6700TE Processor (8M Cache, up to 3.40GHz, 35W TDP)
  - Intel® Core™ i5-6500TE Processor (6M Cache, up to 3.30GHz, 35W TDP)
  - Intel® Core™ i3-6100TE Processor (4M Cache, 2.70 GHz, 35W TDP)
  - Intel® Pentium® Processor G4400TE (3M Cache, 2.40 GHz, 35W TDP)
  - Intel® Celeron® Processor G3900TE (2M Cache, 2.30 GHz, 35W TDP)
  - Intel® Core™ i7-6700 Processor (8M Cache, up to 4.00 GHz, 65W TDP)
  - Intel® Core™ i5-6500 Processor (6M Cache, up to 3.60 GHz, 65W TDP)
  - Intel® Core™ i3-6100 Processor (3M Cache, 3.70 GHz, 51W TDP)
  - Intel® Pentium® Processor G4400 (3M Cache, 3.30 GHz, 54W TDP)
  - Intel® Celeron® Processor G3900 (2M Cache, 2.80 GHz, 51W TDP)

## Chipset

- Intel® Q170

## BIOS

- AMI 16Mbit SPI BIOS

## Memory

- 2x DDR4 260-pin SO-DIMM socket, support up to 64 GB (2133/2400 MHz, un-buffered and non-ECC type)

## Graphics

- Intel® HD Graphics supports triple independent display (1x DVI-I, 2x DP)

## Audio

- Realtek® ALC888-GR
- High Definition Audio

## I/O Interface

- 1x DVI-I Connector, Resolution 1920 x 1080
- 2x DisplayPort Connector, Resolution 3840 x 2160
- 2x GbE LAN (Support WoL, Teaming, Jumbo Frame and PXE), RJ45
  - GbE1: Intel I219-LM
  - GbE2: Intel I210
- 2x RS-232/422/485 with Auto Flow Control Support 5V/12V, DB9
- 6x USB 3.0, Type-A
- 2x USB 2.0, Type-A
- 1x Line-out & 1x Mic-in, Phone Jack 3.5mm
- 1x ATX Power On/Off Switch
- 1x AT/ATX Mode Switch
- 1x Clear CMOS Switch
- 1x Remote Power On/Off Connector, 2-Pin Terminal Block
- 1x Remote Reset Connector, 2-Pin Terminal Block
- 1x External FAN Connector, 4-Pin Terminal Block

## Storage

- 2x 2.5" SATA HDD/SSD Bay, Support RAID 0/1 (Gen3)
- 3x mSATA (shared by Mini-PCIe socket) (Gen3)

## Power Requirement

- Support AT/ATX Power Type
- Power Input Voltage 9-48VDC
- One 3-Pin Terminal Block Connector
- Power Adapter AC/DC 24V/5A 120W or 24V/9.2A 220W (Optional)

## Expansion

- Support CFM (Control Function Module) Technology
  - CFM IGN Module
- Support CMI (Combined Multiple I/O) Technology
  - 4x RJ45 GbE LAN Module - 4x M12 GbE LAN Module
  - 4x RJ45 GbE PoE+ Module - 4x M12 GbE PoE+ Module
  - 4x RS-232/422/485 + 8x Optical Isolated DIO Module
  - 4x Isolated RS-232/422/485 + 8x Optical Isolated DIO Module
- 1x PCI/PCIe Expansion slots (for DS-1101 only)  
Optional Riser Card: • 1x PCIe16 • 1x PCI
- 2x PCI/PCIe Expansion slots (for DS-1102 only)  
Optional Riser Card: • 1x PCIe16+1x PCIe1 • 2x PCIe8  
Optional Riser Card: • 1x PCIe16+1x PCIe1 • 2x PCI  
Support maximum dimension of add-on card (H x L):110mm x 237mm
- 3x Full-size Mini-PCIe Sockets
- 1x SIM Socket

## Other Function

- Support Instant Reboot Technology (0.2 sec)
- SuperCap Integrated for CMOS Battery Maintenance-free Operation
- Watchdog Timer: Software Programmable Supports 256 Levels System Reset
- Power Ignition Sensing (IGN) Function (with optional CFM module) 12V/24V Selectable

## Physical

- Dimension (WxDxH): 227 x 261 x 128 mm
- Weight: 4.70 kg
- Extruded Aluminum with Heavy Duty Metal
- Support Wall Mounting • Unibody Chassis
- Fanless Design • Jumper-less Design

## Protection

- Reverse Power Input Protection
- Over Voltage Protection
  - Protection Range: 51-58V
  - Protection Type: shut down operating voltage, re-power on at the present level to recover
- Over Current Protection: 15A
- ESD Protection: +/-8kV (air), +/-4kV (contact)
- Surge Protection: 2kV

## Operating System

- 7th Generation Intel® CPU (Kaby Lake-S): Windows® 10
- 6th Generation Intel® CPU (Skylake-S): Windows® 10/ 8.1/ 7
- Linux: Supports by project

## Environment

- Operating Temperature:
  - 7th Generation Intel® CPU (Kaby Lake-S)
    - 35W TDP CPU: -40°C to 50°C
    - 51W~65W TDP CPU: -40°C to 45°C
  - 6th Generation Intel® CPU (Skylake-S)
    - 35W TDP CPU: -40°C to 70°C
    - 51~65W TDP CPU: -40°C to 50°C(With extended temperature peripherals; Ambient with air flow; According to IEC60068-2-1, IEC60068-2-2, IEC60068-2-14)
- Storage Temperature: -40°C to 85°C
- Relative Humidity: 70°C @ 95% RH (Non-condensing)
- EMC: CE, FCC Class A
- Safety: LVD EN62368-1
- Railway: EN50155, EN50121-3-2
- In-Vehicle: E-Mark (E13, No.10R-0514229) Certified

# 1.6 System I/O

## 1.6.1 Front

### ATX Power On/Off

Used to power-on or power-off the system

### AT/ATX Mode Select Switch

Used to select AT or ATX power mode

### Power LED

Indicates the power status of the system

### Temperature LED

Indicates the temperature of the system

### HDD LED

Indicates the status of the hard drive

### Digital I/O LED

Indicates the working status of digital input/output

### Ethernet LED

Indicates the status of the LAN ports

### USB 3.0 Port

Used to connect USB 3.0/2.0/1.1 device

### USB 2.0 Port

Used to connect USB 2.0/1.1 device

### DisplayPort

Used to connect the system with DisplayPort monitor

### SIM card, CMOS Battery, and 2.5" Removable HDD Bay

### Removable HDD Bay

Used to insert a SIM card, CMOS battery, and 2.5" HDD

## DS-1100

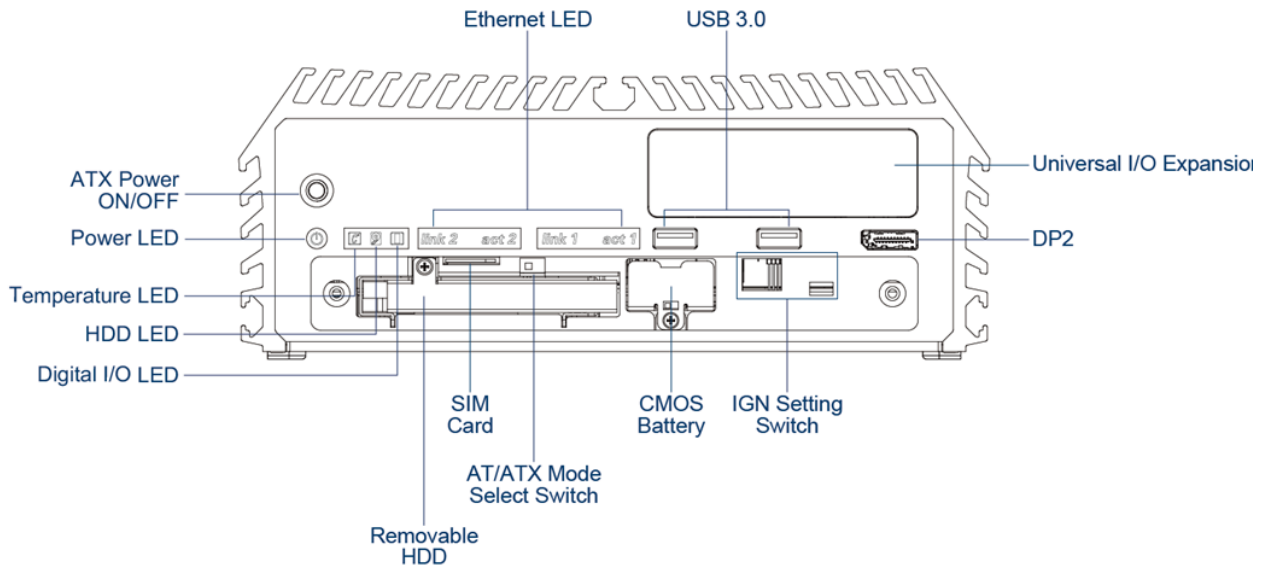

## DS-1101

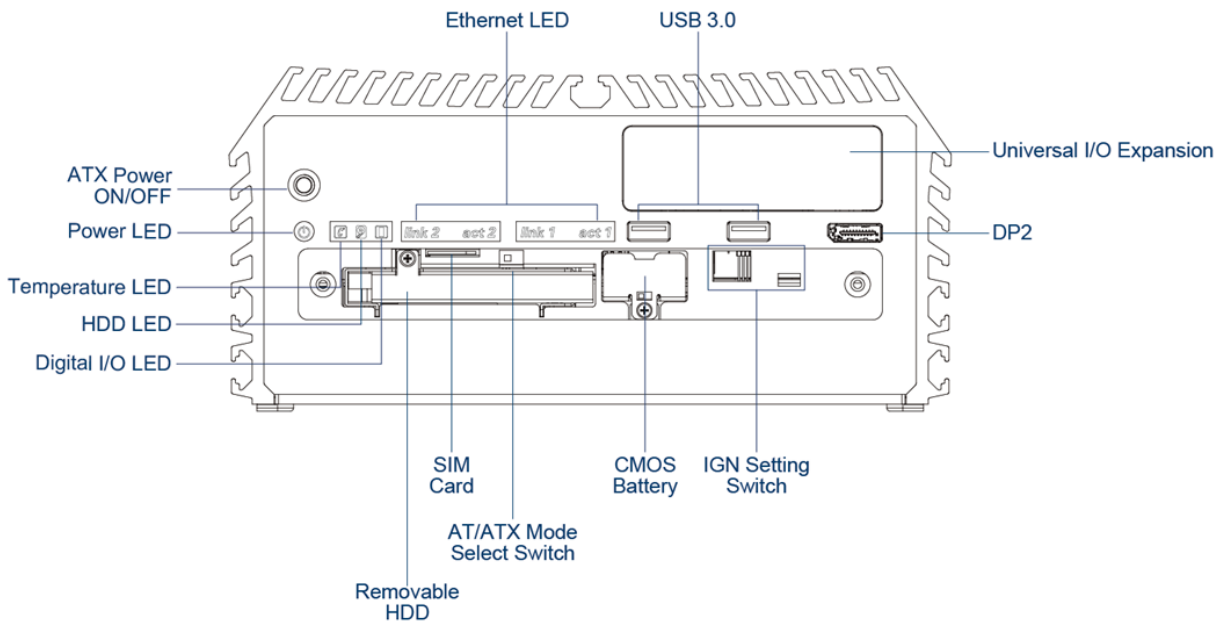

## DS-1102

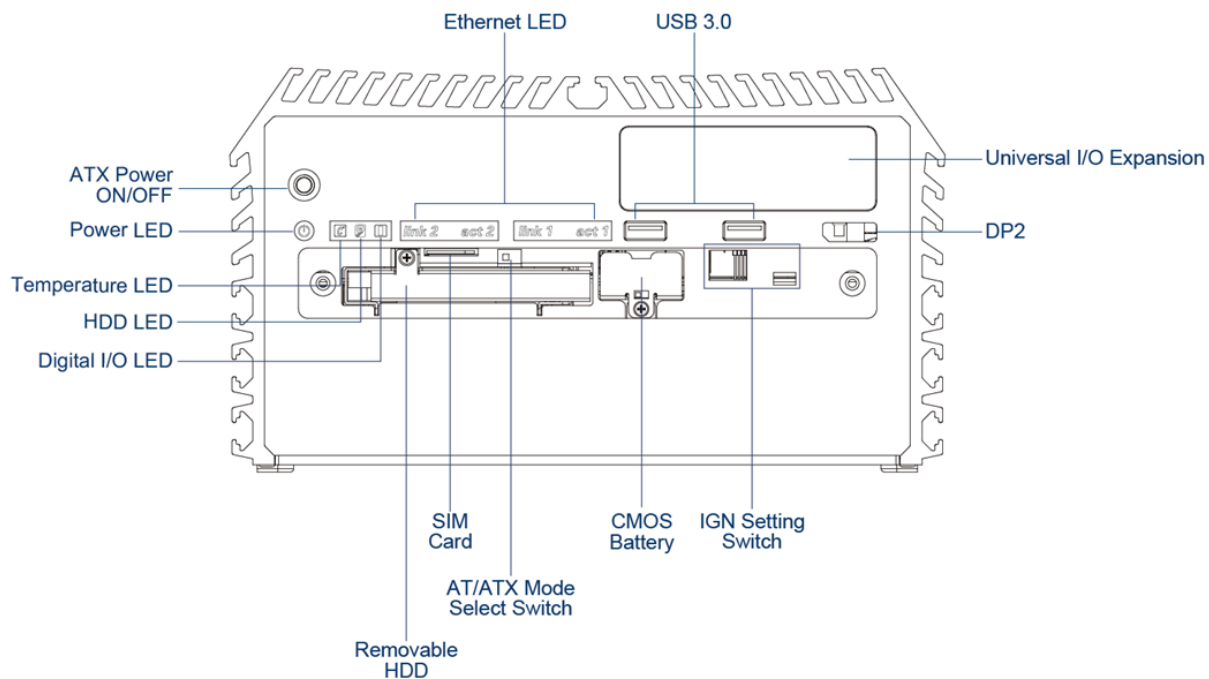



## 1.6.2 Rear

### DC IN Terminal Block

Used to plug a DC power input with terminal block

### External Fan Terminal Block

Used to plug an external fan with terminal block

### DVI-I Port

Used to connect a DVI monitor or connect optional split cable for dual display mode

### PS/2 Port

Used to connect the PS/2 device

### LAN Port

Used to connect to local area network

### Display Port

Used to connect a monitor with DisplayPort interface

### USB 3.0 Port

Used to connect USB 3.0/2.0/1.1 device

### USB 2.0 Port

Used to connect USB 2.0/1.1 device

### Antenna Hole

Used to connect an antenna for optional wireless module

### COM Port

Used to connect to RS-232/422/485 serial devices

### Line-Out

Used to connect a speaker

### Mic-In

Used to connect a microphone

### Remote Power On/Off & Remote Power Reset Terminal Block

A terminal block used to connect to remote power on/off switch

### Universal I/O Bracket

Used to customized I/O output

## DS-1100

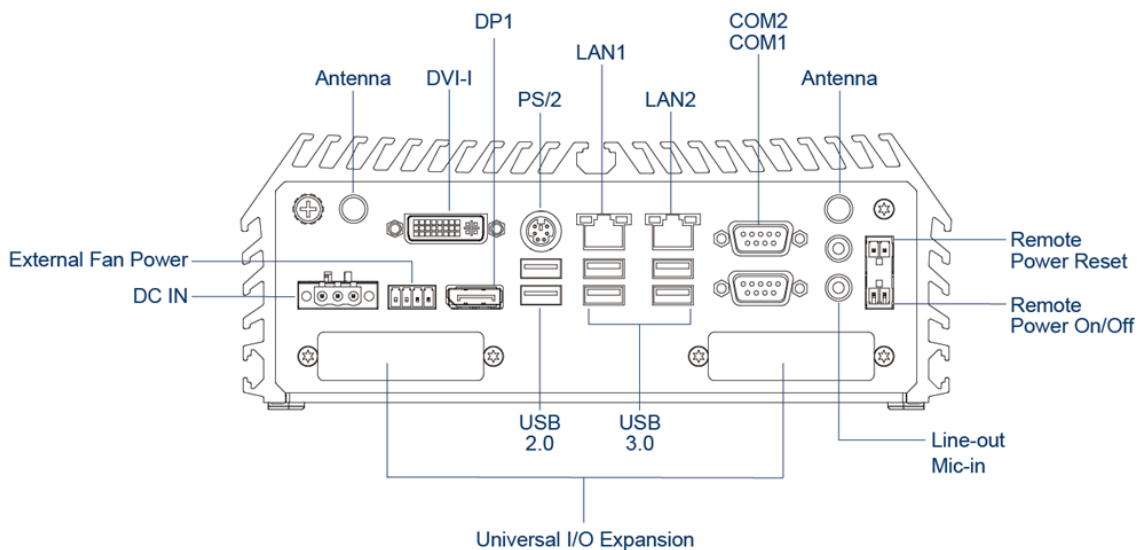

## DS-1101

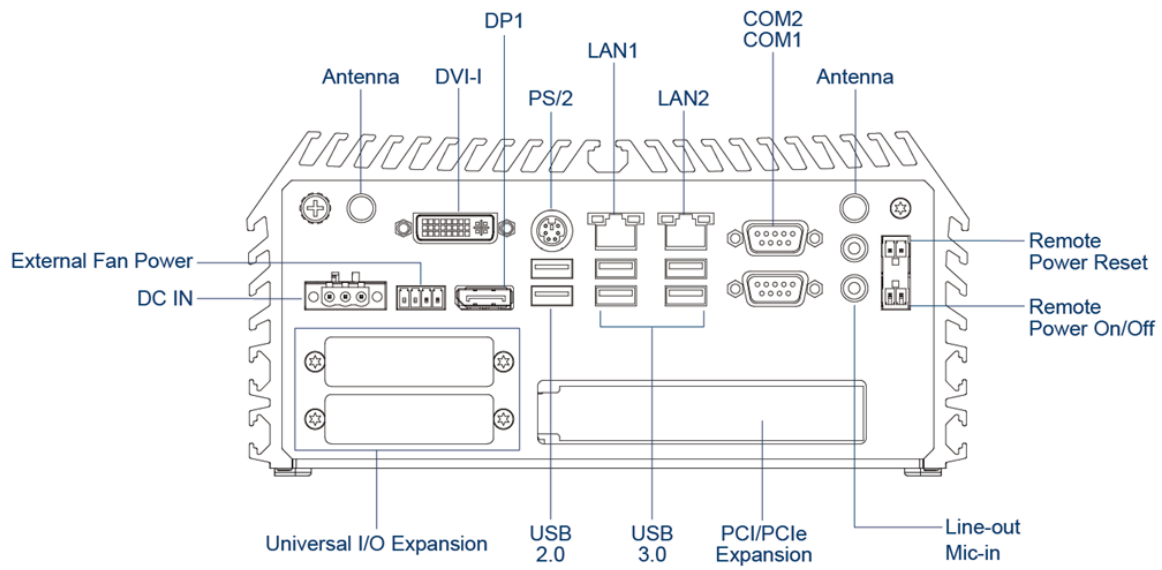

## DS-1102

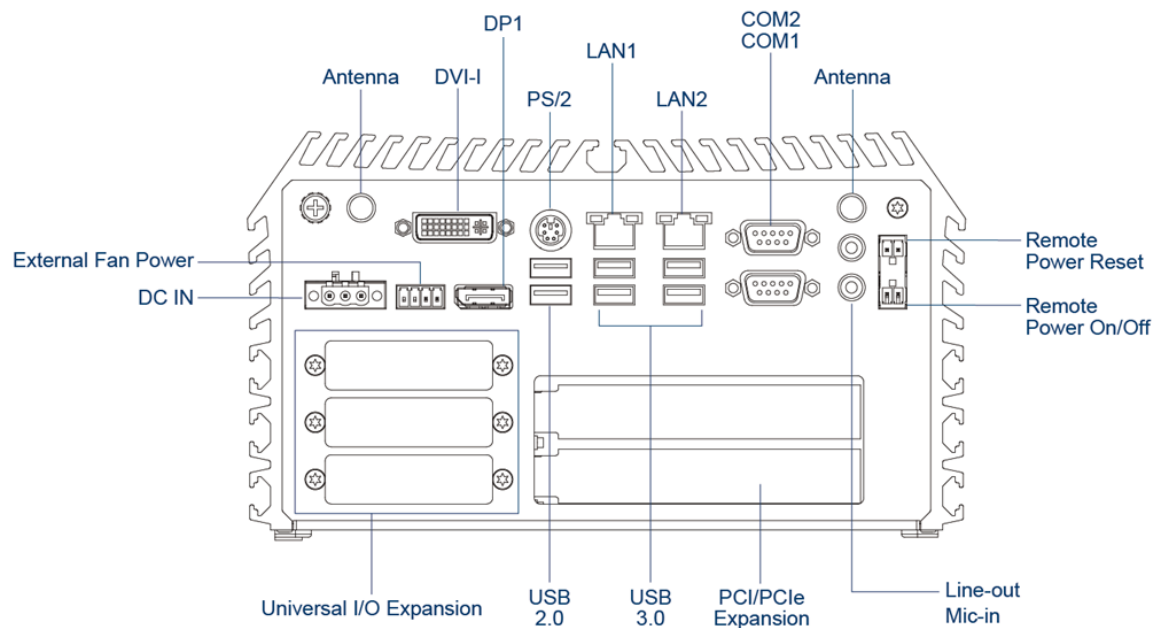

# 1.7 Mechanical Dimension

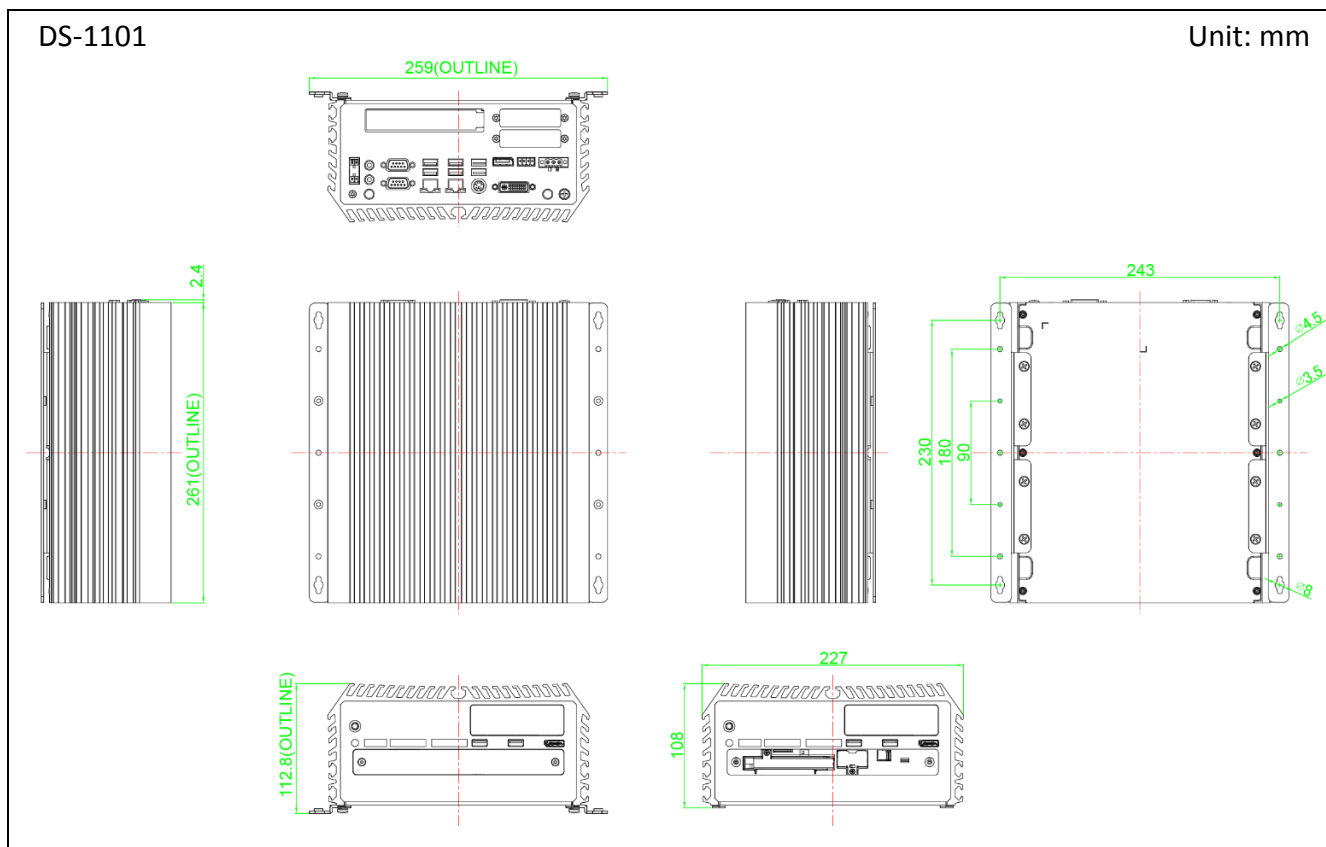
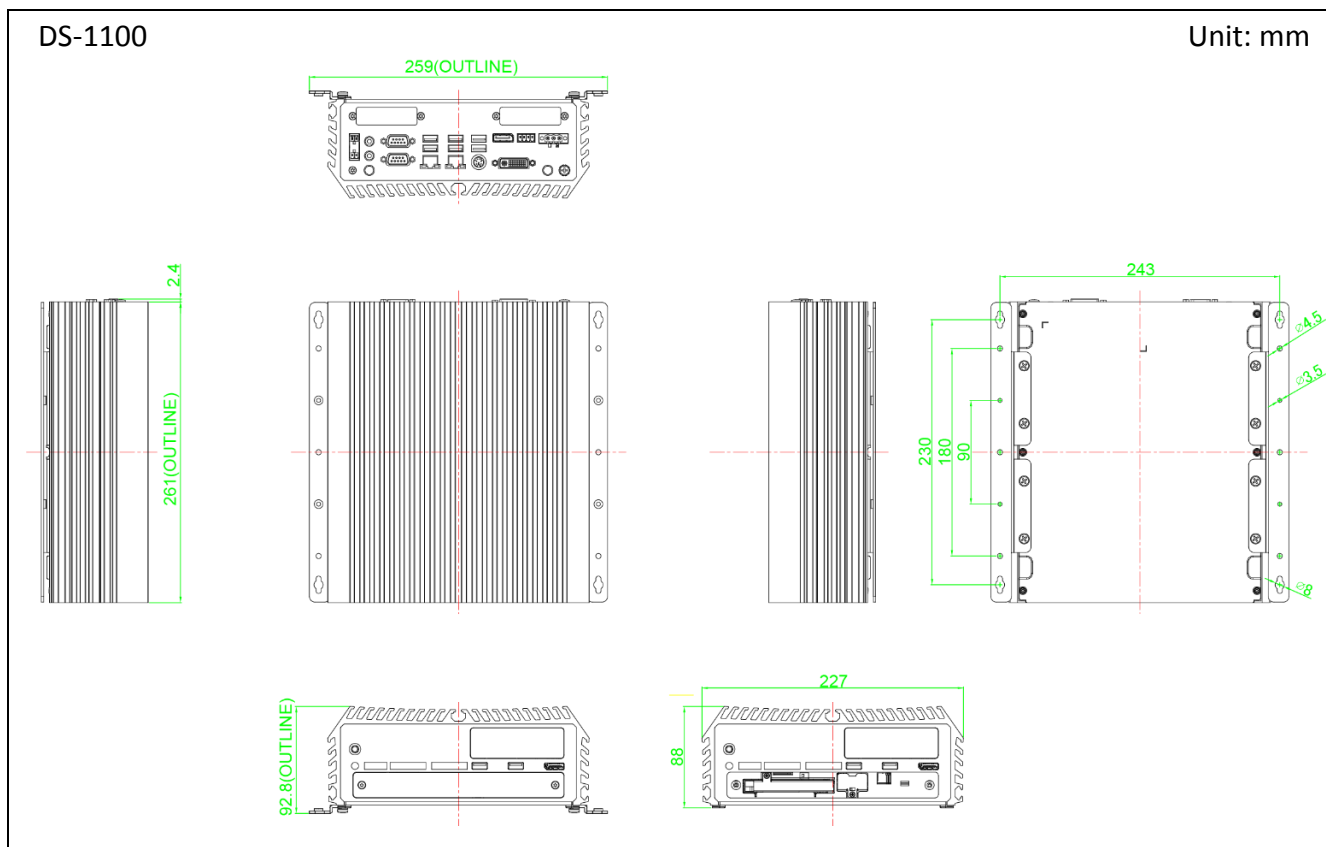

DS-1102

Unit: mm

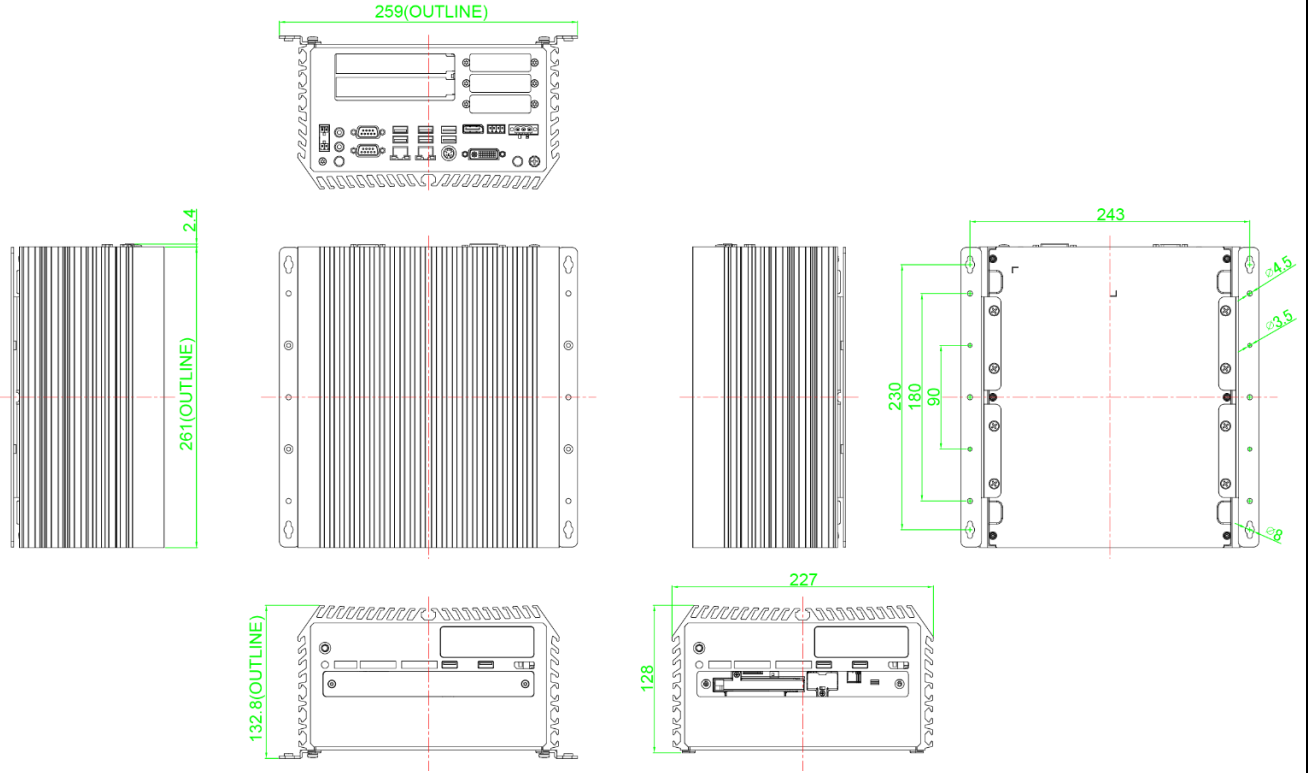



# **Chapter 2**

## **Switches & Connectors**

## 2.1 Location of Switches and Connectors

### 2.1.1 Top View

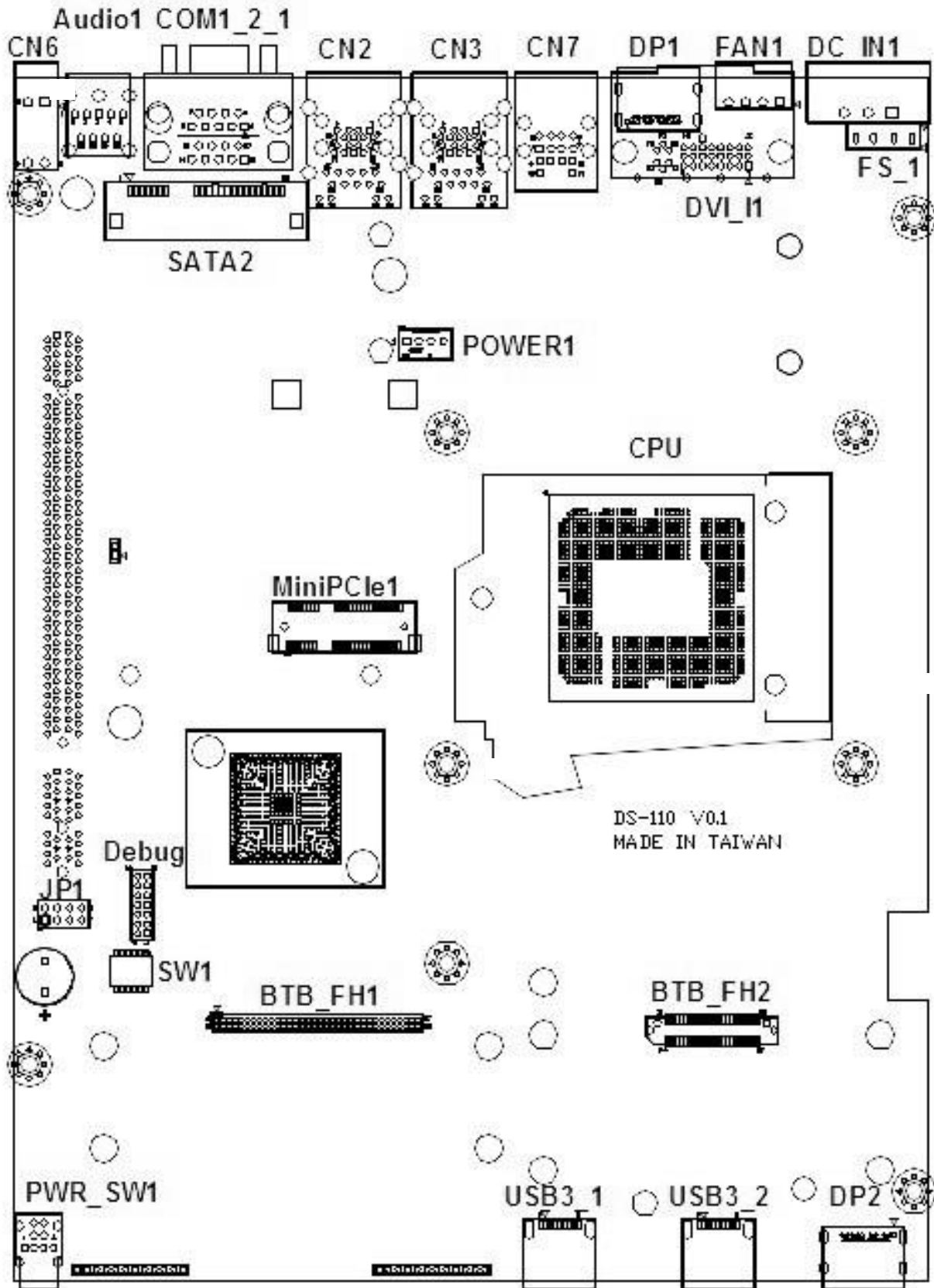

## 2.1.2 Bottom View

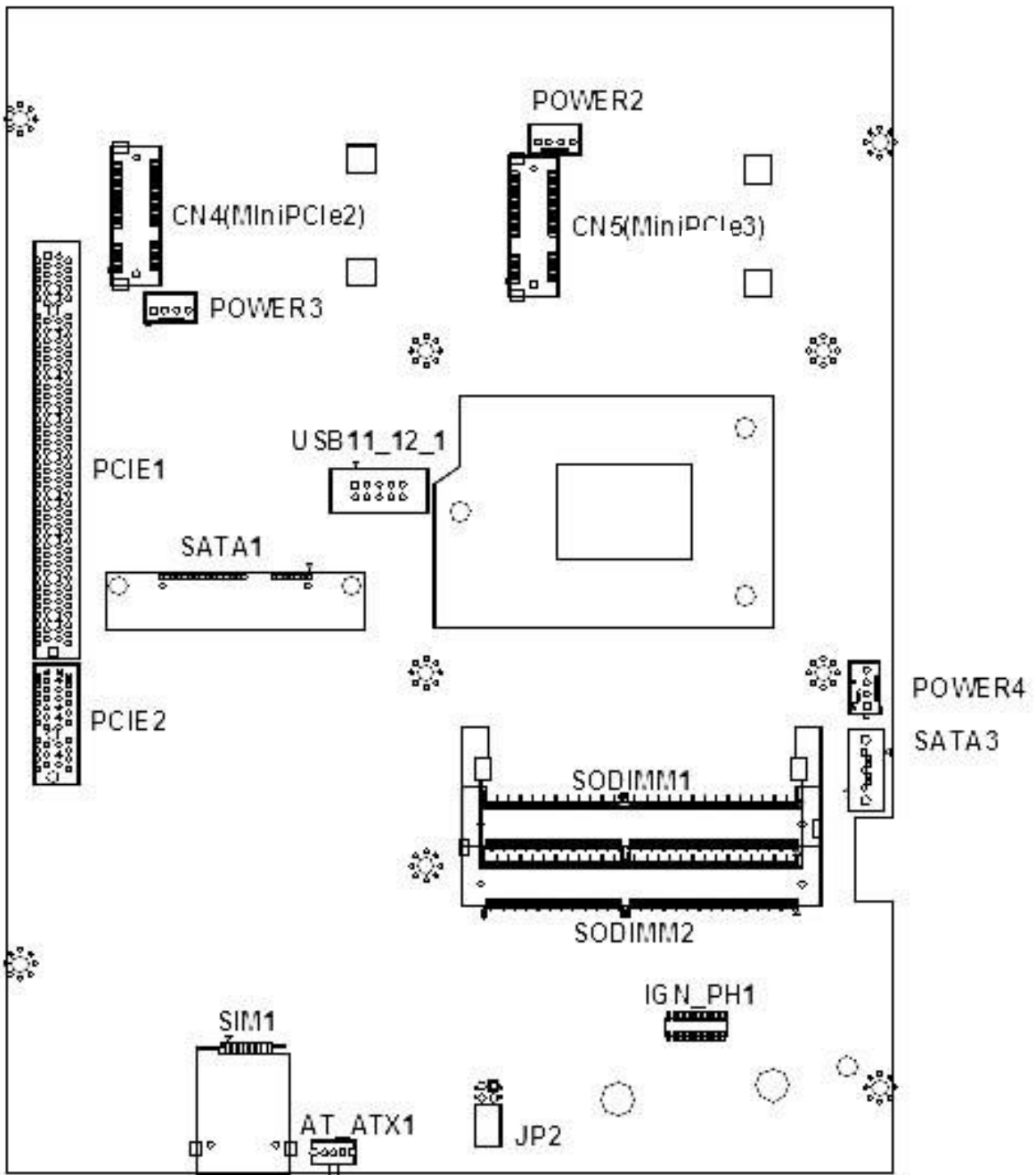

## 2.2 Switches and Connectors Definition

### List of Switch and Connectors

| Location       | Definition   |
|----------------|--|
| SW1            | RTC/SATA DOM/COM1/COM2 Power Select                      |
| JP2            | RTC Battery board to board connector                     |
| AT_ATX1        | AT/ATX Power Mode Switch                                 |
| LED1           | System LED Connector                                     |
| BTB_FH1        | DIO+COM Port Board to Board Connector                    |
| BTB_FH2        | PSE LAN Port Board to Board Connector                    |
| IGN_PH1        | IGN Board to Board Connector                             |
| PWR_SW1        | Power Switch   |
| FS1            | Input Fuse 15A   |
| DC_IN1         | 3-pin DC 9-48V Power Input with Power Ignition Connector |
| FAN1           | External PWM Fan Connector                               |
| DP1            | DisplayPort Connector                                    |
| DP2            | DisplayPort Connector                                    |
| DVI_I1         | DVI-I Connector  |
| CN7            | PS/2 and USB2.0 Ports                                    |
| CN2            | LAN1 and USB3.0 Ports                                    |
| CN3            | LAN2 and USB3.0 Ports                                    |
| COM1_2_1       | COM1/COM2 RS232/RS422/RS485 Connector                    |
| AUDIO1         | Audio Jack/MIC_IN/LINE_OUT                               |
| CN6            | Remote Power on/off, Remote Reset Switch Connector       |
| USB3_1, USB3_2 | USB 3.0 Ports  |
| SIM1           | SIM Card Socket  |
| SATA0,1        | 22 Pin SATA Connector                                    |
| SATA3          | SATA Dom Connector                                       |
| Power 1~4      | Power Connector  |
| MINIPCIE1      | Mini PCI-Express Socket + mSATA + 3G Module              |
| CN4,5          | Mini PCI-Express / mSATA Socket                          |
| USB11_12_1     | Internal USB 2.0 Ports                                   |
| PCIE1          | PCI-Express x16 Socket                                   |
| PCIE2          | PCI-Express x1 Socket                                    |
| SODIMM1,2      | DDR4 SODIMM Socket                                       |



## 2.3 Definition of Switches

### AT\_ATX1: AT / ATX Power Mode Switch

| Switch      | Definition               |
|-------------|--------------------------|
| 1-2 (Left)  | AT Power Mode            |
| 2-3 (Right) | ATX Power Mode (Default) |



### SW1: RTC / SATA DOM / COM1 / COM2 Power Select

#### Super CAP Function Setting: Pin Define SW1 Switch

| Switch mode | Function  | ON               | OFF     |
|-------------|-----------|------------------|---------|
| 1           | Super CAP | Enable (Default) | Disable |

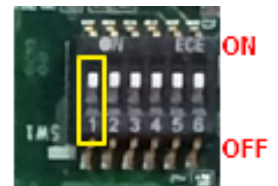

#### SATA DOM Function Setting: Pin Define SW1 Switch

| Switch mode | Function | ON                | OFF    |
|-------------|----------|-------------------|--------|
| 2           | SATA DOM | Disable (Default) | Enable |

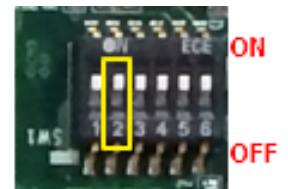

#### COM1/2 Voltage Function Setting: Pin Define SW1 Switch

| Switch mode | Function | ON     | OFF             |
|-------------|----------|--------|-----------------|
| 3-4         | COM1     | 0V(RI) | ON/ON (Default) |
|             |          | 5V     | ON/OFF          |
|             |          | 12V    | OFF/OFF         |
| 5-6         | COM2     | 0V(RI) | ON/ON (Default) |
|             |          | 5V     | ON/OFF          |
|             |          | 12V    | OFF/OFF         |

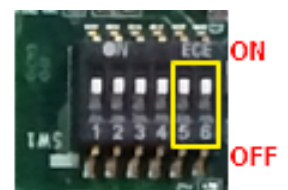
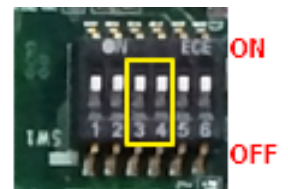

## 2.4 Definition of Connectors

### CN8: Mini PCI-Express Socket (Support mSATA and SIM Card to Link feature)

| Pin | Definition | Pin | Definition  | Pin | Definition |
|-----|------------|-----|-------------|-----|------------|
| 1   | WAKE#      | 19  | NA          | 37  | RESERVED   |
| 2   | 3.3V       | 20  | 3.3V        | 38  | USB_D+     |
| 3   | NA         | 21  | GND         | 39  | RESERVED   |
| 4   | GND        | 22  | PERST#      | 40  | GND        |
| 5   | NA         | 23  | PERN/SATARP | 41  | 3.3V       |
| 6   | 1.5V       | 24  | +3.3VAUX    | 42  | NA         |
| 7   | CLKREQ#    | 25  | PERP/SATARN | 43  | GND        |
| 8   | RESERVED   | 26  | GND         | 44  | NA         |
| 9   | GND        | 27  | GND         | 45  | NA         |
| 10  | SIM_DATA   | 28  | +1.5V       | 46  | NA         |
| 11  | REFCLK-    | 29  | GND         | 47  | NA         |
| 12  | SIM_CLK    | 30  | SMB_CLK     | 48  | +1.5V      |
| 13  | REFCLK+    | 31  | PETN/SATATN | 49  | NA         |
| 14  | SIM_Reset  | 32  | SMB_DATA    | 50  | GND        |
| 15  | GND        | 33  | PETP/SATATP | 51  | NA         |
| 16  | SIM_VPP    | 34  | GND         | 52  | +3.3V      |
| 17  | NA         | 35  | GND         |     |            |
| 18  | GND        | 36  | USB_D-      |     |            |

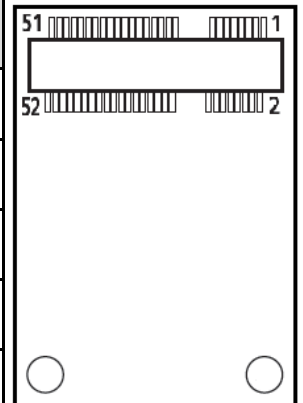

**CN4/CN5: Mini PCI-Express Socket (Support mSATA feature)**

| Pin | Definition | Pin | Definition  | Pin | Definition |
|-----|------------|-----|-------------|-----|------------|
| 1   | WAKE#      | 19  | NA          | 37  | GND        |
| 2   | 3.3V       | 20  | 3.3V        | 38  | USB_D+     |
| 3   | NA         | 21  | GND         | 39  | 3.3V       |
| 4   | GND        | 22  | PERST#      | 40  | GND        |
| 5   | NA         | 23  | PERN/SATARP | 41  | 3.3V       |
| 6   | 1.5V       | 24  | +3.3VAUX    | 42  | NA         |
| 7   | NA         | 25  | PERP/SATARN | 43  | GND        |
| 8   | NA         | 26  | GND         | 44  | NA         |
| 9   | GND        | 27  | GND         | 45  | NA         |
| 10  | NA         | 28  | +1.5V       | 46  | NA         |
| 11  | REFCLK-    | 29  | GND         | 47  | NA         |
| 12  | NA         | 30  | SMB_CLK     | 48  | +1.5V      |
| 13  | REFCLK+    | 31  | PETN/SATATN | 49  | NA         |
| 14  | NA         | 32  | SMB_DATA    | 50  | GND        |
| 15  | GND        | 33  | PETP/SATATP | 51  | NA         |
| 16  | NA         | 34  | GND         | 52  | +3.3V      |
| 17  | NA         | 35  | GND         |     |            |
| 18  | GND        | 36  | USB_D-      |     |            |

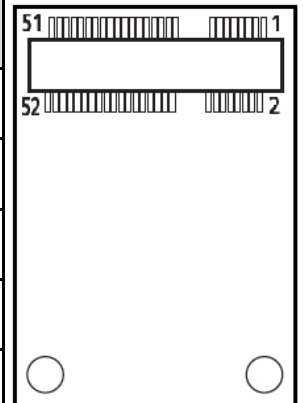

### POWER1, POWER2, POWER3, POWER4: Power Connector

Connector Type: 1X4-pin Wafer, 2.54mm pitch

| Pin | Definition |
|-----|------------|
| 1   | +5V        |
| 2   | GND        |
| 3   | GND        |
| 4   | +12V       |

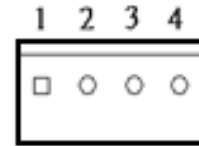

### SATA5: SATA Connector (SATA DOM)

| Pin | Definition | Pin | Definition |
|-----|------------|-----|------------|
| 1   | GND        | 5   | RX2-       |
| 2   | TX2+       | 6   | RX2+       |
| 3   | TX2-       | 7   | NC/+5V     |
| 4   | GND        |     |            |



### CLR\_CMOS1: Clear CMOS Switch

| Pin         | Definition              |
|-------------|-------------------------|
| 1-2 (Left)  | Normal Status (Default) |
| 2-3 (Right) | Clear CMOS              |



### LED\_B1: PWR / HDD / IGN / TEMP LED Status

| LED B1    | Status                    | LED Color               |
|-----------|---------------------------|-------------------------|
| Power LED | Power ON                  | Green                   |
|           | Standby                   | Blinking Green and Blue |
| HDD LED   | HDD Read/Write            | Blinking Yellow         |
| TEMP LED  | System Temp ≤ 65°C        | Colorless               |
|           | 65°C < System Temp ≤ 70°C | Blue                    |
|           | 70°C < System Temp ≤ 75°C | Red                     |
|           | 75°C < System Temp        | Blinking Red            |

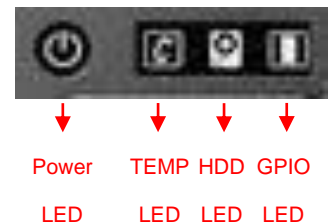

**NOTE**

**The TEMP LED is only available when IGN module is installed.**

## LAN LED Status Defines

| Act LED Status  | Definition    | Link LED Status | Definition           |
|-----------------|---------------|-----------------|----------------------|
| Blinking Yellow | Data Activity | Steady Green    | 1Gbps Network Link   |
| Off             | No Activity   | Steady Orange   | 100Mbps Network Link |
|                 |               | Off             | 10Mbps Network Link  |

## DC\_IN1: DC Power Input Connector (+9-48V)

Connector Type: Terminal Block 1x3 3-pin, 5.0mm pitch

| Pin | Definition     |
|-----|----------------|
| 1   | +9-48VIN       |
| 2   | Ignition (IGN) |
| 3   | GND            |

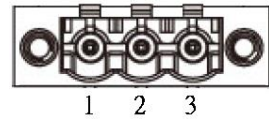

**CAUTION**

**Please disconnect the power source before mounting the DC power cables or connecting the DC power connector to system.**

## FAN1: External PWM Fan Connector

Connector Type: Terminal Block 1X4 4-pin, 3.5mm pitch

| Pin | Definition |
|-----|------------|
| 1   | GND        |
| 2   | +12V       |
| 3   | SENSE      |
| 4   | Control    |

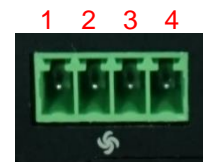

## CN6: Remote Power on/off, Remote Reset Switch Connector

| Pin | Definition |
|-----|------------|
| 1   | PWR_SW     |
| 2   | RESET_SW   |
| 3   | GND        |
| 4   | GND        |

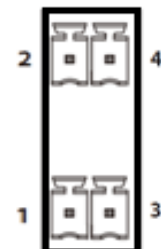

**WARNING**

**Do not apply power to this connector!  
This port is used to connect a SWITCH!**

## COM1\_2\_1: RS232 / RS422 / RS485 Connector

Connector Type: 9-pin D-Sub

| Pin | RS232 Definition | RS422 / 485 Full Duplex Definition | RS485 Half Duplex Definition |
|-----|------------------|------------------------------------|------------------------------|
| 1   | DCD              | TX-                                | DATA -                       |
| 2   | RXD              | TX+                                | DATA +                       |
| 3   | TXD              | RX+                                |                              |
| 4   | DTR              | RX-                                |                              |
| 5   | GND              |                                    |                              |
| 6   | DSR              |                                    |                              |
| 7   | RTS              |                                    |                              |
| 8   | CTS              |                                    |                              |
| 9   | RI               |                                    |                              |

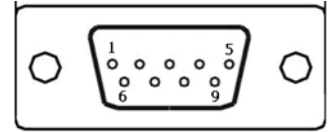

# Optional Low Speed CMI Module (CMI-CD100)

| Model No.      | Product Description  |
|----------------|--|
| CMI-CD100/FB20 | CMI Module with 4x RS-232/422/485 Serial Ports, 8x Optical Isolated DIO (4 in/4 out), 1x DS-1100 Front Bezel |
| CMI-CD100/FB21 | CMI Module with 4x RS-232/422/485 Serial Ports, 8x Optical Isolated DIO (4 in/4 out), 1x DS-1101 Front Bezel |
| CMI-CD100/FB22 | CMI Module with 4x RS-232/422/485 Serial Ports, 8x Optical Isolated DIO (4 in/4 out), 1x DS-1102 Front Bezel |



## COM34\_SEL1: COM3 / COM4 with Power Select

Connector Type: 2X5 10-pin Header, 2.54mm pitch

| COM3                |            | COM4                 |            |
|---------------------|------------|----------------------|------------|
| Pin                 | Definition | Pin                  | Definition |
| 1-3 On              | +5V        | 2-4 On               | +5V        |
| 3-5 On              | +12V       | 4-6 On               | +12V       |
| 7-9 On<br>(Default) | RI3        | 8-10 On<br>(Default) | RI4        |

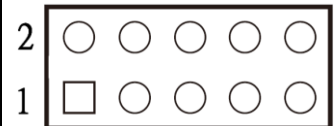

## COM56\_SEL1: COM5 / COM6 with Power Select

Connector Type: 2X5 10-pin Header, 2.54mm pitch

| COM5                |            | COM6                 |            |
|---------------------|------------|----------------------|------------|
| Pin                 | Definition | Pin                  | Definition |
| 1-3 On              | +5V        | 2-4 On               | +5V        |
| 3-5 On              | +12V       | 4-6 On               | +12V       |
| 7-9 On<br>(Default) | RI5        | 8-10 On<br>(Default) | RI6        |

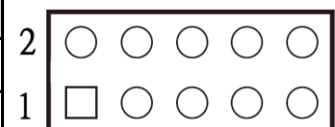

### COM3/COM4/COM5/COM6: RS232 / RS422 / RS485 Connector

Connector Type: 9-pin D-Sub

| Pin | RS232 Definition | RS422 / 485 Full Duplex Definition | RS485 Half Duplex Definition |
|-----|------------------|------------------------------------|------------------------------|
| 1   | DCD              | TX-                                | DATA -                       |
| 2   | RXD              | TX+                                | DATA +                       |
| 3   | TXD              | RX+                                |                              |
| 4   | DTR              | RX-                                |                              |
| 5   | GND              |                                    |                              |
| 6   | DSR              |                                    |                              |
| 7   | RTS              |                                    |                              |
| 8   | CTS              |                                    |                              |
| 9   | RI               |                                    |                              |

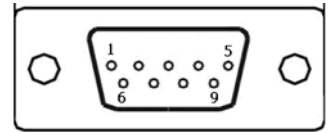

### DIO1: Digital Input / Output Connector

Connector Type: Terminal Block 2X5 10-pin, 3.5mm pitch

| Pin | Definition | Pin | Definition |
|-----|------------|-----|------------|
| 1   | DI1        | 2   | DO1        |
| 3   | DI2        | 4   | DO2        |
| 5   | DI3        | 6   | DO3        |
| 7   | DI4        | 8   | DO4        |
| 9   | DC INPUT   | 10  | GND        |

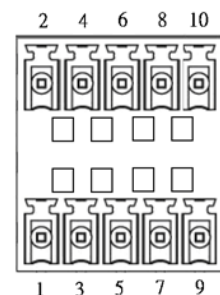



# Optional Low Speed CMI Module (CMI-ICD100)

| Model No.       | Product Description  |
|-----------------|--|
| CMI-ICD100/FB20 | CMI Module with 4x Electrical Isolated RS-232/422/485 Serial Ports, 8x Optical Isolated DIO (4 in/4 out), 1x DS-1100 Front Bezel |
| CMI-ICD100/FB21 | CMI Module with 4x Electrical Isolated RS-232/422/485 Serial Ports, 8x Optical Isolated DIO (4 in/4 out), 1x DS-1101 Front Bezel |
| CMI-ICD100/FB22 | CMI Module with 4x Electrical Isolated RS-232/422/485 Serial Ports, 8x Optical Isolated DIO (4 in/4 out), 1x DS-1102 Front Bezel |



## COM3/COM4/COM5/COM6: RS232 / RS422 / RS485 Connector

Connector Type: 9-pin D-Sub

| Pin | RS232 Definition | RS422 / 485 Full Duplex Definition | RS485 Half Duplex Definition |
|-----|------------------|------------------------------------|------------------------------|
| 1   |                  | TX-                                | DATA -                       |
| 2   | RXD              | TX+                                | DATA +                       |
| 3   | TXD              | RX+                                |                              |
| 4   |                  | RX-                                |                              |
| 5   | GND              |                                    |                              |
| 6   |                  |                                    |                              |
| 7   | RTS              |                                    |                              |
| 8   | CTS              |                                    |                              |
| 9   |                  |                                    |                              |

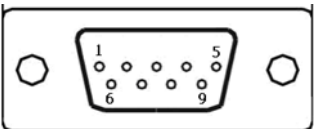

**NOTE**

**COM3/4/5/6 are isolated COM, each pin5 (GND) is independent.**

# Optional High Speed CMI Module

## CMI-M12LAN01 Module Pin Definitions

Connector Type: M12 A coded 8pin connector

| Pin | Definition | Pin | Definition |
|-----|------------|-----|------------|
| 1   | 2_LAN1_0+  | 2   | 2_LAN1_0-  |
| 3   | 2_LAN1_1+  | 4   | 2_LAN1_2+  |
| 5   | 2_LAN1_2-  | 6   | 2_LAN1_1-  |
| 7   | 2_LAN1_3+  | 8   | 2_LAN1_3-  |

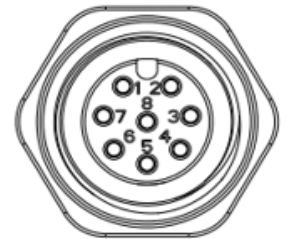

## CMI-XM12LAN01 Module Pin Definitions

Connector Type: M12 X coded 8pin connector

| Pin | Definition | Pin | Definition |
|-----|------------|-----|------------|
| 1   | D1+        | 2   | D1-        |
| 3   | D2+        | 4   | D2-        |
| 5   | D4+        | 6   | D4-        |
| 7   | D3-        | 8   | D3+        |

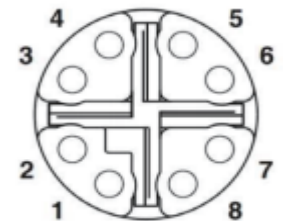

# Optional CFM-IGN Power Ignition Module

| Model No.  | Product Description  |
|------------|--|
| CFM-IGN101 | CFM Module with Power Ignition Sensing Control Function, 12V/24V Selectable (43 x 36 mm) |

## Power Ignition Setting

| Connector Location | Definition                                  |
|--------------------|---|
| SW2                | Ignition Function Setting                   |
| 24V_12V_1          | 24V/ 12V Power Switching for Ignition Board |

## SW2: Set shutdown delay timer when ACC is turned off

| Pin 1          | Pin 2 | Pin 3 | Pin 4 | Definition          |
|----------------|-------|-------|-------|---------------------|
| OFF<br>/<br>ON | ON    | ON    | ON    | 0 second            |
|                | ON    | ON    | OFF   | 1 minute            |
|                | ON    | OFF   | ON    | 5 minutes           |
|                | ON    | OFF   | OFF   | 10 minutes          |
|                | OFF   | ON    | ON    | 30 minutes          |
|                | OFF   | ON    | OFF   | 1 hour              |
|                | OFF   | OFF   | ON    | 2 hours             |
|                | OFF   | OFF   | OFF   | Reserved (0 second) |





# **Chapter 3**

## **System Setup**

This chapter takes DS-1100 as an example to demonstrate the installation of hardware components, except for chapter 3.12.

## 3.1 Removing the Top Cover



### WARNING

In order to prevent electric shock or system damage, before removing the chassis cover, must turn off power and disconnect the unit from power source.

1. Turn over the unit to have the bottom side face up, loosen the 6 screws on the bottom cover and place them aside for later use.



2. Remove the bottom cover from the chassis.



3. Unscrew the 2 screws at rear panel as marked on photo and place them aside for later use.



4. Loosen the 4 screws. Pull out 4 latches as marked on photo.

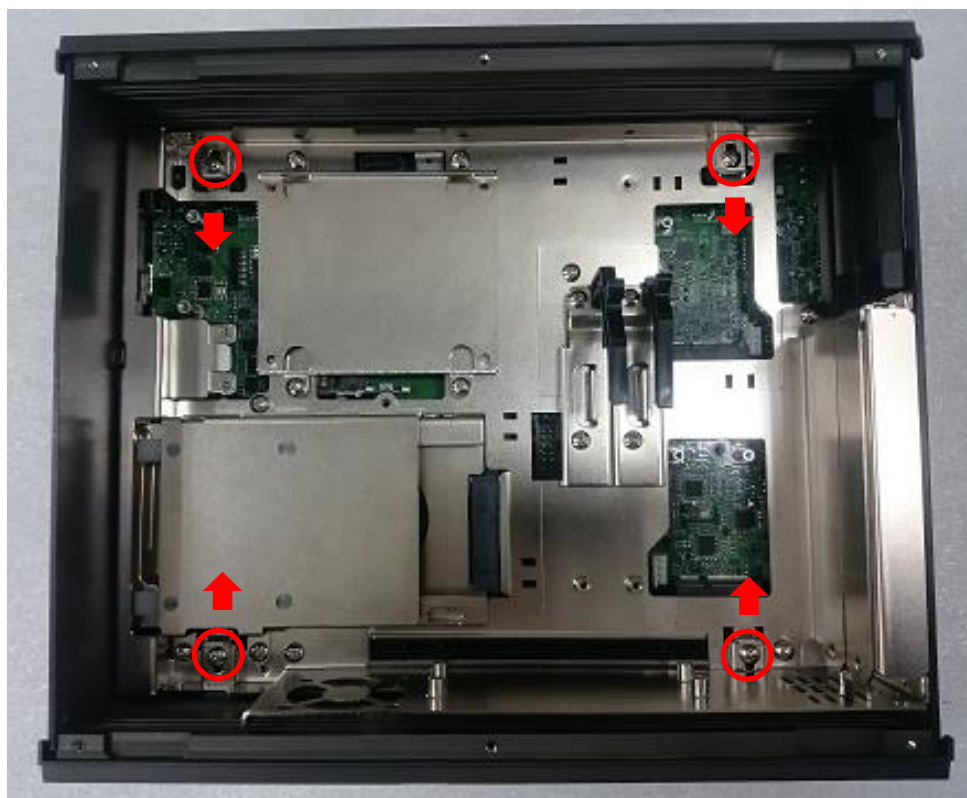

5. Lift up the unit vertically by holding the front and rear panel.

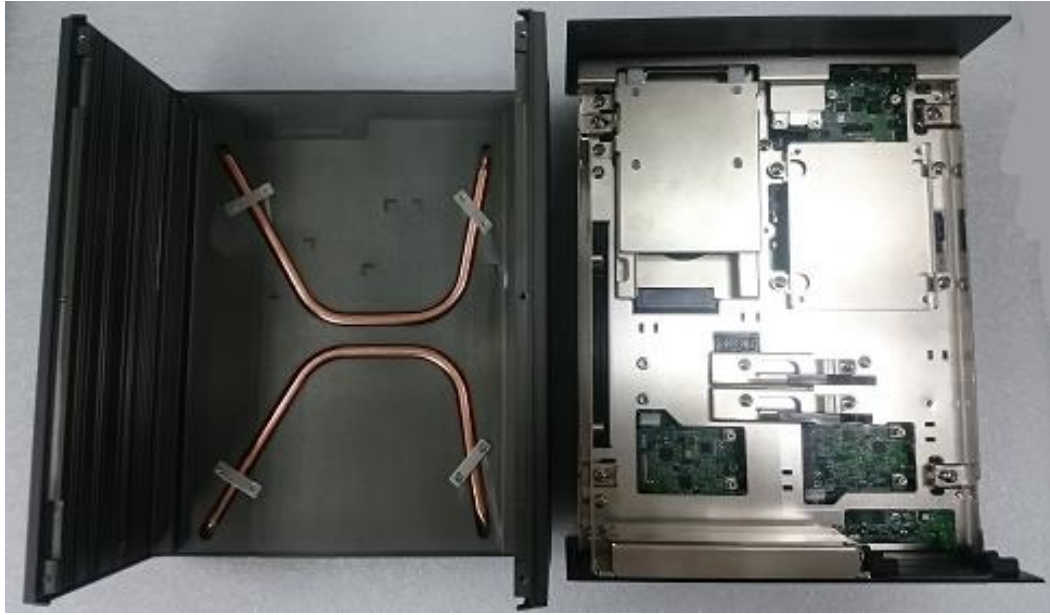

6. Turn over the body of the unit and place it gently.



## 3.2 Installing the CPU

1. Locate the CPU socket, remove the protection cover on it.



2. Press the CPU socket lever and pull it aside away from the socket to unlock it. Pull back the lever to open the socket.





- Align the notches on CPU with the alignment post on socket.



- The notches of socket provide the space for fingers while lowering the CPU, hold the CPU by the edges toward the notches and insert the CPU gently.



5. Align mounting holes of heatsink with the nut studs and fasten the heat sink with provided 4 screws.

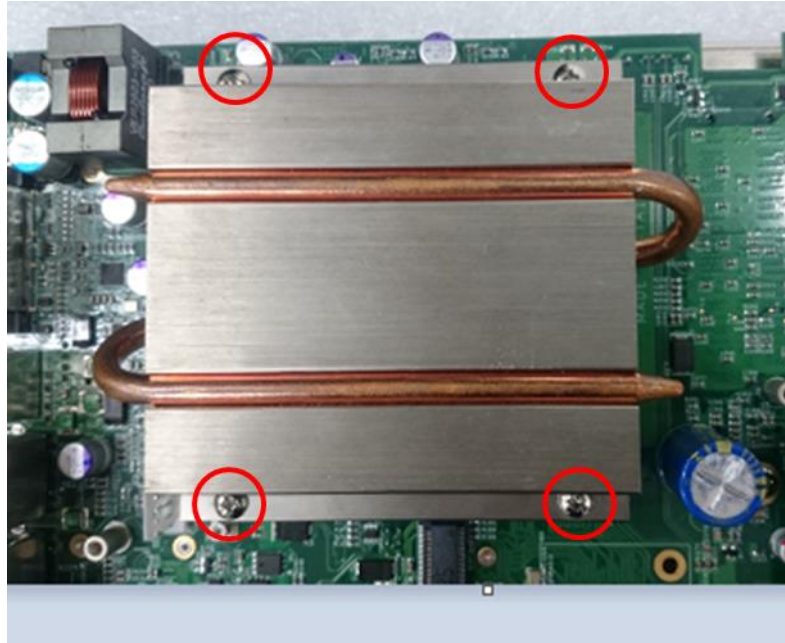

### 3.3 Installing SO-DIMM Memory

1. Locate the SO-DIMM sockets at the bottom side of system. Unscrews the 4 screws and remove the bracket.

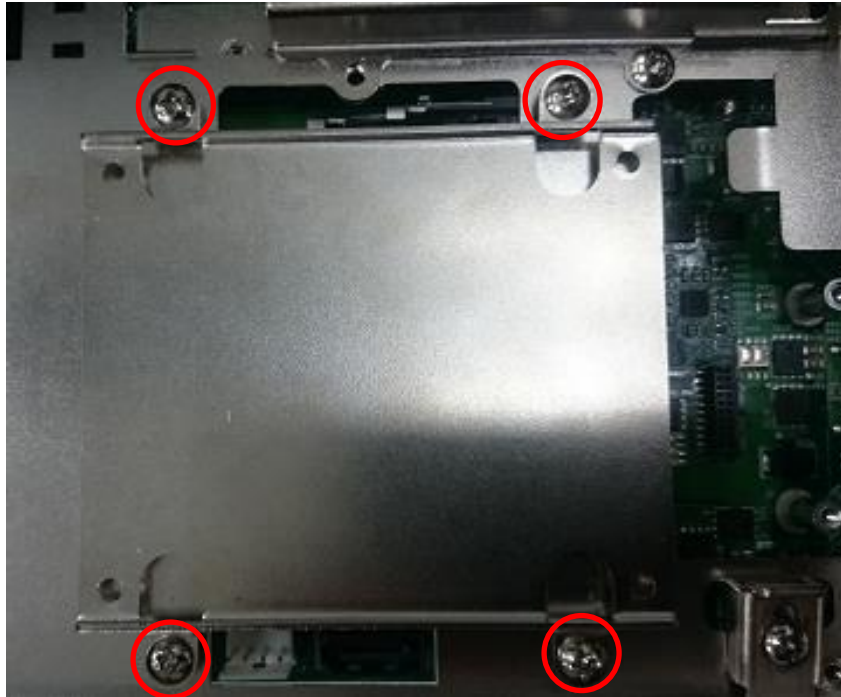

2. Locate two SO-DIMM sockets at the bottom.



3. Tilt the SO-DIMM module at a 45-degree angle and insert it to SO-DIMM socket until the gold-pated connector of module contacted firmly with the socket.



Lower socket

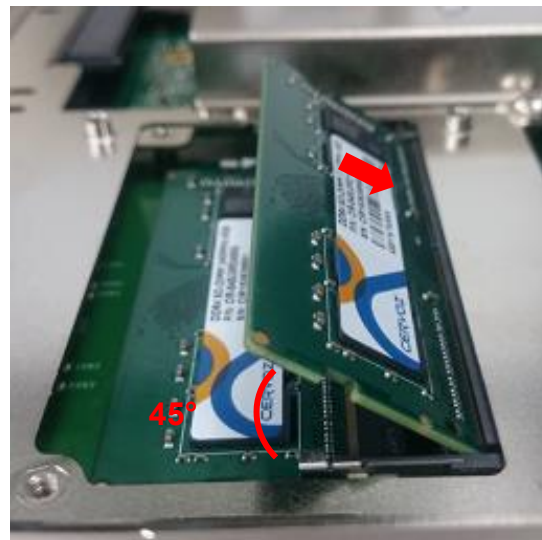

Upper socket

4. Press the modules down until it's fixed firmly by the two locking latches on the sides.



5. Put the cover back and fix the cover with 4 screws.

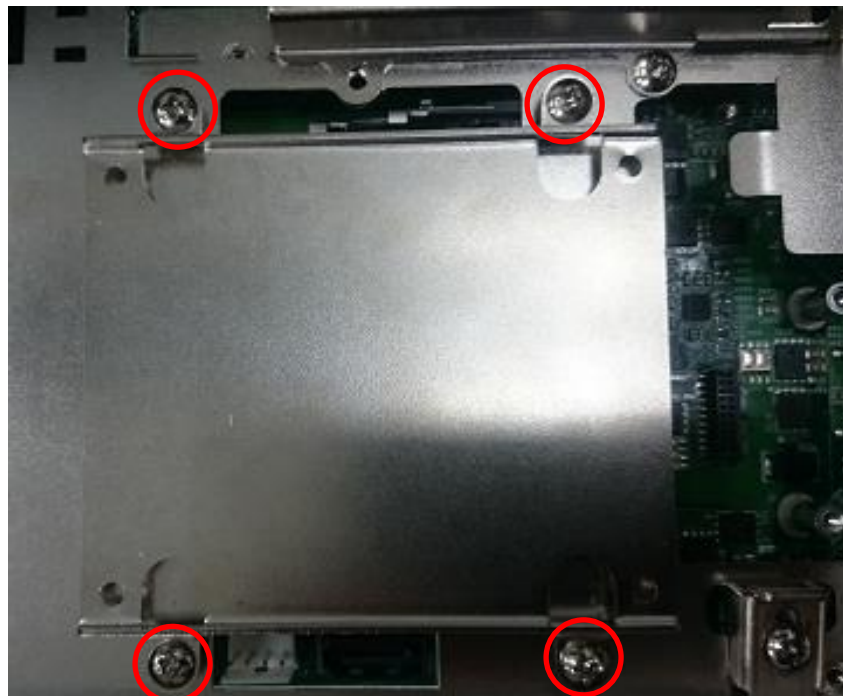

## 3.4 Installing a Mini-PCle/mSATA Card on Top Side (Applicable for full or half size card)

1. Locate the Mini PCIe socket on the top side of system.



2. Use provided two screws fasten the half size module and adapter bracket together as shown in Fig (a) below.



(a) Half Size Mini-PCle Card



(b) Full Size Mini-PCle Card

3. Insert the Mini-PCle card at a 45-degree angle until its edge connector is connected firmly into slot.



4. Press down the module and fasten two screws to secure the module.



## 3.5 Installing a Mini-PCle/mSATA Card on Bottom Side (Applicable for full or half size card)

1. Turn over the body of the unit. Locate Mini-PCle (mSATA) slots at the bottom.

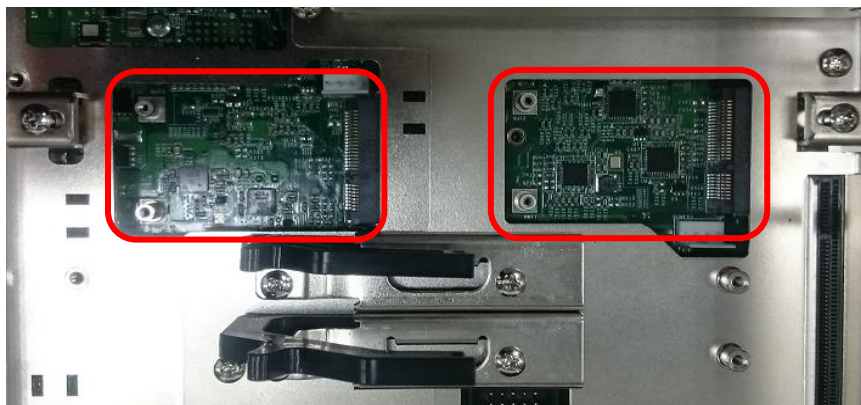

2. Tilt the Mini-PCle module at a 45-degree angle and insert it to the slot until the gold-pated connector of module contacted firmly with the slot.



3. Press down the module and use previous two screws to fix the module.





## 3.6 Installing Antennas

1. Remove the antenna rubber covers on rear panel.



2. Have antenna jack penetrate through the hole.



3. Put on washer and fasten the nut with antenna jack.



4. Assemble the antenna and antenna jack together.



5. Attach the RF connector at another end of cable onto the module.



## 3.7 Installing a SATA Hard Drive on Top Side

1. Unscrew the 3 screws on HDD bracket and remove the bracket.



2. Make the PCB side of the HDD face up, place the HDD bracket on it. Ensure the direction of bracket is correct and use 4 provided screws to assemble HDD and HDD bracket together.

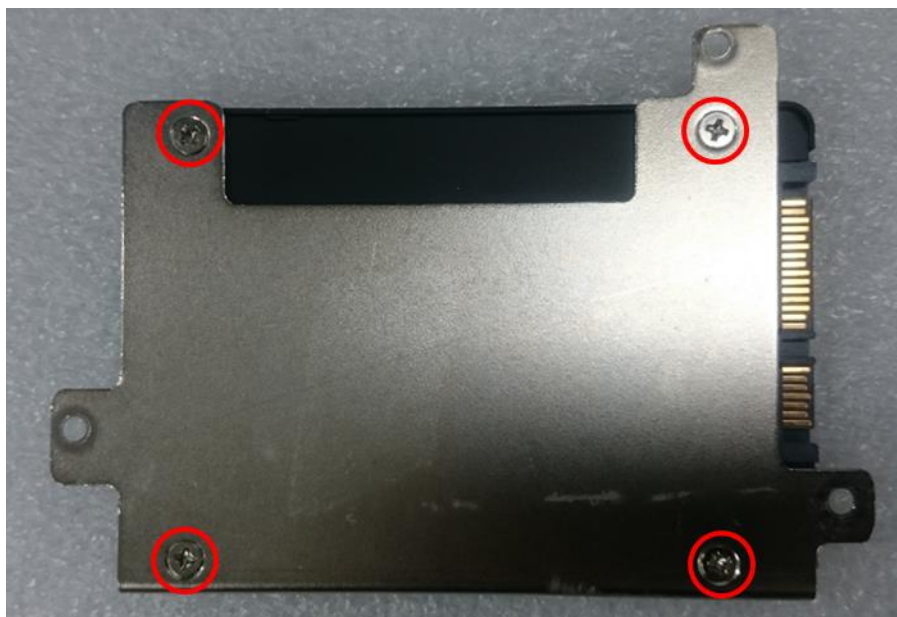

3. Turn over the HDD bracket. Connect the HDD bracket to the SATA connector and fasten the 3 screws.



## 3.8 Installing a Low Speed CMI Module

The applicable low speed CMI modules for DS1100 series are listed in the following table.

| Model No.       | Product Description  |
|-----------------|--|
| CMI-CD100/FB20  | CMI Module with 4x RS-232/422/485 Serial Ports, 8x Optical Isolated DIO (4 in/4 out), 1x DS-1100 Front Bezel                     |
| CMI-CD100/FB21  | CMI Module with 4x RS-232/422/485 Serial Ports, 8x Optical Isolated DIO (4 in/4 out), 1x DS-1101 Front Bezel                     |
| CMI-CD100/FB22  | CMI Module with 4x RS-232/422/485 Serial Ports, 8x Optical Isolated DIO (4 in/4 out), 1x DS-1102 Front Bezel                     |
| CMI-ICD100/FB20 | CMI Module with 4x Electrical Isolated RS-232/422/485 Serial Ports, 8x Optical Isolated DIO (4 in/4 out), 1x DS-1100 Front Bezel |
| CMI-ICD100/FB21 | CMI Module with 4x Electrical Isolated RS-232/422/485 Serial Ports, 8x Optical Isolated DIO (4 in/4 out), 1x DS-1101 Front Bezel |
| CMI-ICD100/FB22 | CMI Module with 4x Electrical Isolated RS-232/422/485 Serial Ports, 8x Optical Isolated DIO (4 in/4 out), 1x DS-1102 Front Bezel |



**NOTE**

**The photo example used in this section is illustrated CMI-ICD100/FB22 module.**

1. Loosen the 2 hex nuts from back side of front bezel. Remove the front bezel.



2. Locate the connector of CMI-module on top side of system.



3. Insert the CMI module carefully into the CMI connector on main board. Fix it with 4 screws.

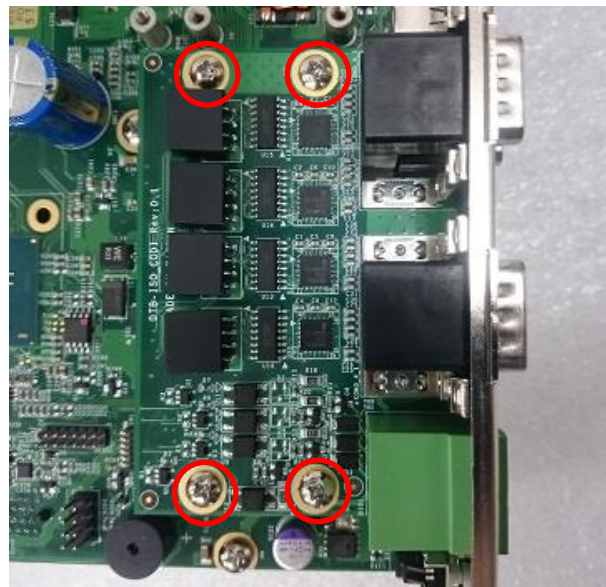

4. Fasten the 8 D-Sub jack screws as marked on photo.

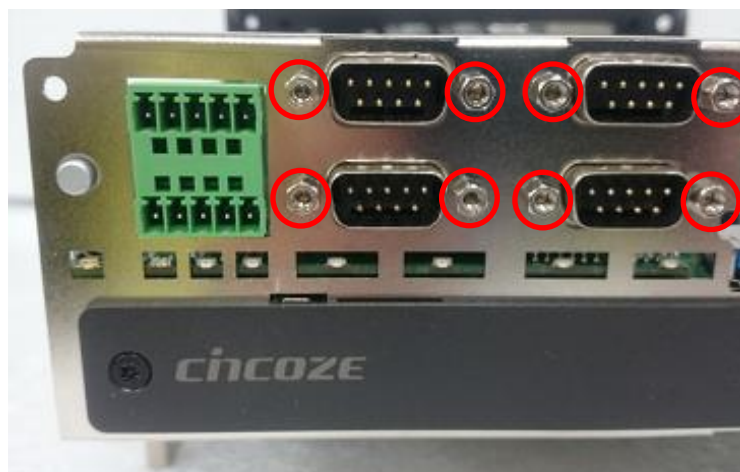

5. Exchange with the front bezel of low speed CMI module as illustrated.



front bezel for  
CMI-COM  
module



6. Fasten the 2 hex nuts from the back side of front bezel.



## 3.9 Installing a High Speed CMI Module

The applicable high speed CMI modules for DS1100 series are CMI-LAN01-R12/UB0612, CMI-M12LAN01-R12/UB0610, and CMI-XM12LAN01-R12/UB0630.

### 3.9.1 CMI-M12LAN01-R12/UB0610

1. Loosen the 2 hex nuts from back side of front bezel. Remove the front bezel.



2. Locate the connector of CMI module on top side of system.



3. Remove the 4 ring nuts from M12 jack before attempting to install the module.





4. (1) Penetrate M12 jack of the module through the I/O hole. (2) Insert the LAN module carefully into the CMI connector on main board as illustrated.

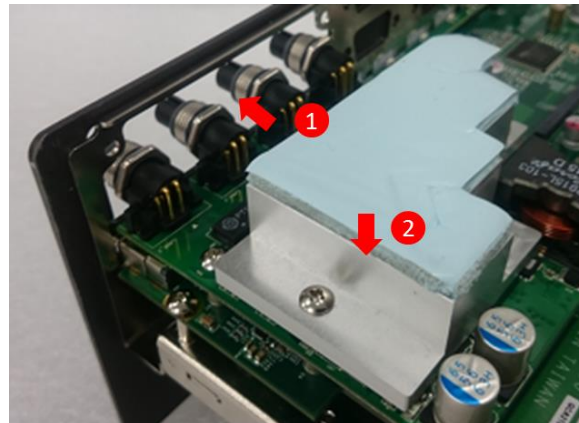

5. Fasten 3 screws to fix the module.

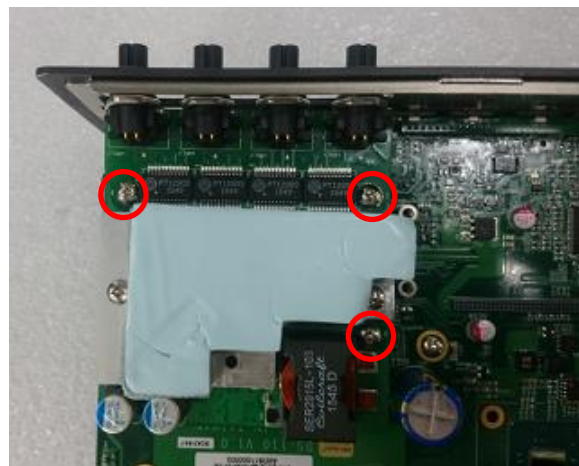

**CAUTION**

**Before assembling the system's chassis cover, please make sure the protective film on the Thermal Pad has been removed!**

6. Attach the M12 I/O bracket, and fasten 2 hex nuts from the back side of the bracket.

M12 I/O bracket

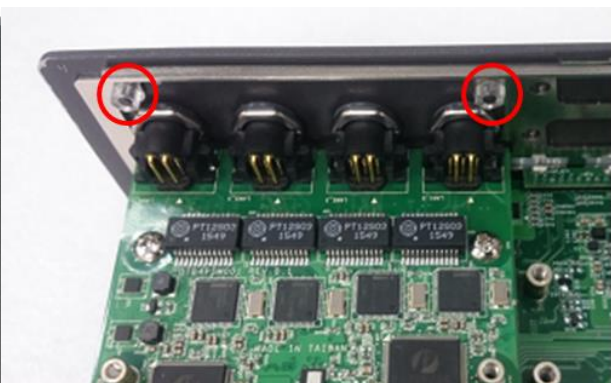

7. Fasten the 4 ring nuts onto M12 jacks.



### 3.9.2 CMI-XM12LAN01-R12/UB0630

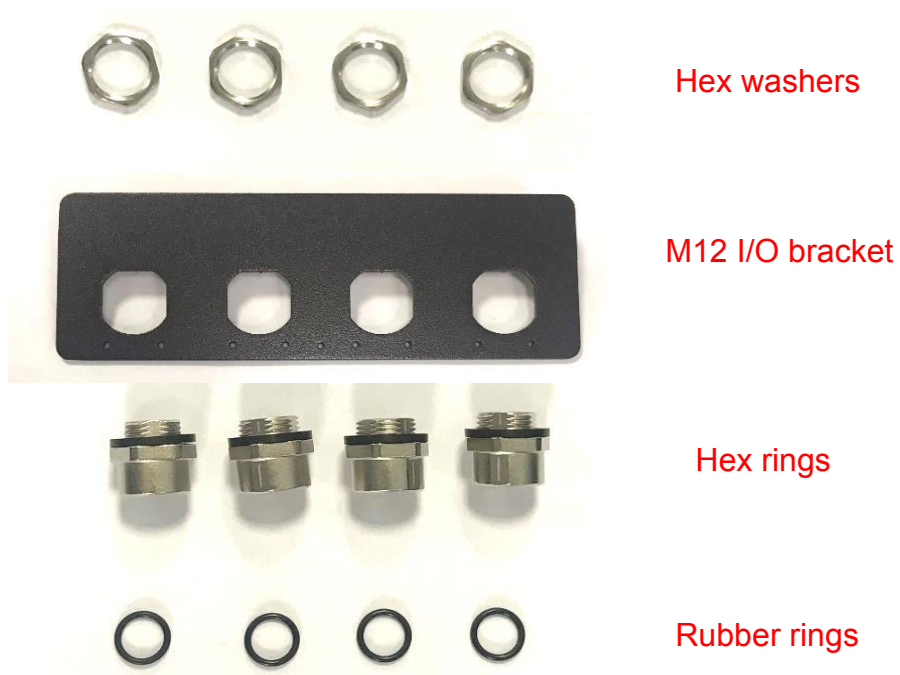

1. Assemble the hex rings, M12 I/O bracket and hex washers together as indicated below:  
Penetrate hex rings through the M12 I/O bracket holes, and fix them with hex washers.



2. Loosen the 2 hex nuts from back side of front bezel. Remove the front bezel.



3. Locate the connector of CMI module on top side of system.



4. Insert the LAN module carefully into the CMI connector on main board and fasten the four screws.



5. Attach the assembled M12 I/O bracket on to the system, and fasten the hex nuts to fix it.

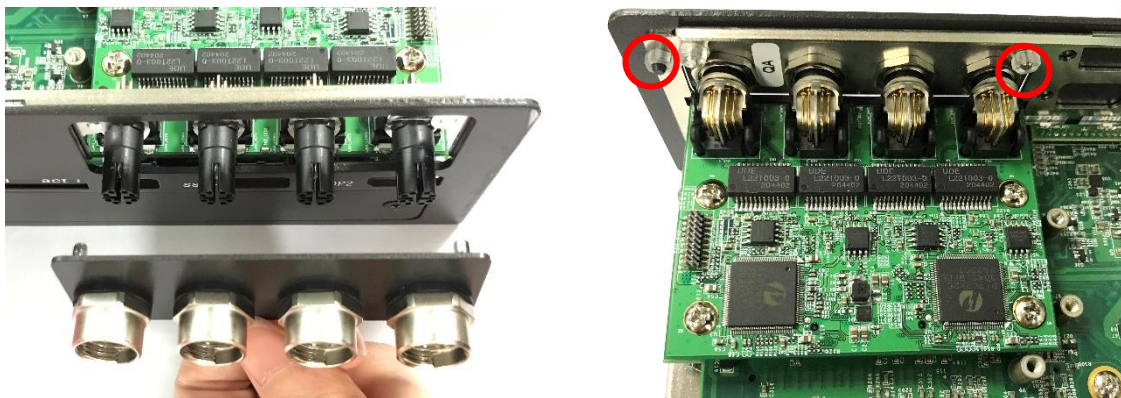

6. Put on the rubber rings to the four M12 LAN ports.



## 3.10 Installing a CFM-IGN Power Ignition Module

1. Locate power ignition connector on main board.



2. Insert the power ignition module carefully into the connector on main board. Fasten 2 screws to fix it.

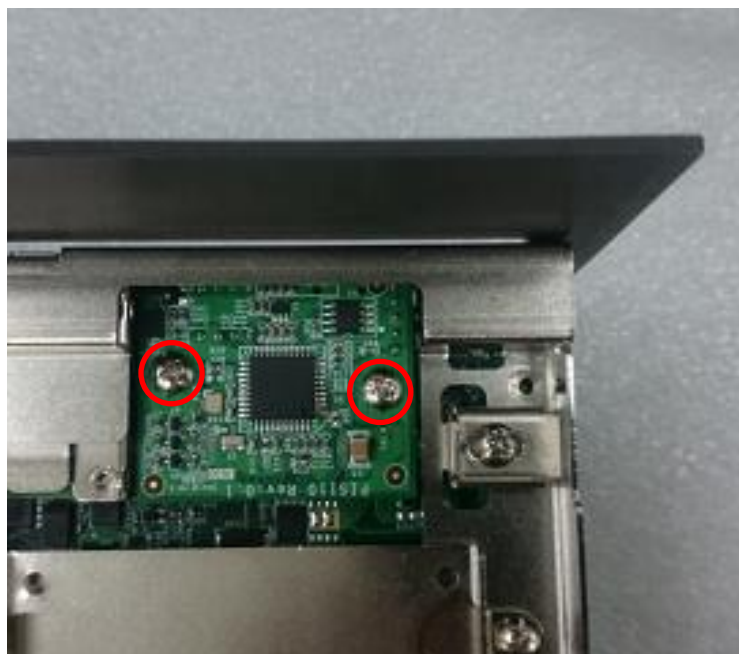

### 3.11 Installing the Internal FAN (For DS-1102 only)

1. Unscrew 6 screws to remove 3 I/O brackets from rear panel.



2. Attach the FAN from back side of rear panel. Fasten 4 screws to fix it.



3. Connect the FAN power cable to the power connector on main board.as marked on photo.



## 3.12 Installing a PCI/PCIe Add-on Card

### (For DS-1101 and DS-1102 only)

The applicable riser cards for DS-1100 series are listed in the following table.

| Model No.   | Description                      |
|-------------|----------------------------------|
| RC-E16-01   | Riser Card 1 x PCIe16            |
| RC-PI-01    | Riser Card 1 x PCI               |
| RC-E16E1-01 | Riser Card 1 x PCIe16, 1 x PCIe1 |
| RC-E8E8-R10 | Riser Card 2 x PCIe8             |
| RC-E16PI-01 | Riser Card 1 x PCIe16, 1 x PCI   |
| RC-PIPI-01  | Riser Card 2 x PCI               |



**NOTE**

The photo example in this section is illustrated by RC-E16PI-01 module.

1. Prepare a Riser Card intended for installation.



Riser Card RC-E16PI-01

2. Unscrew the 4 screws to remove the extension bracket.

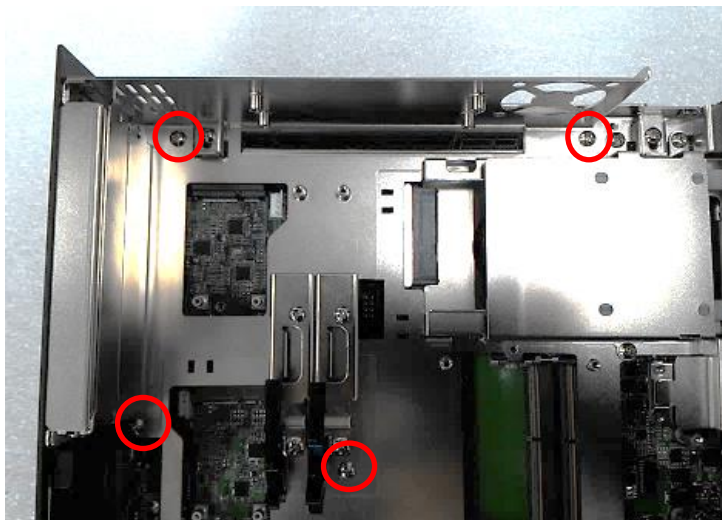

3. Remove the extension bracket from the system.

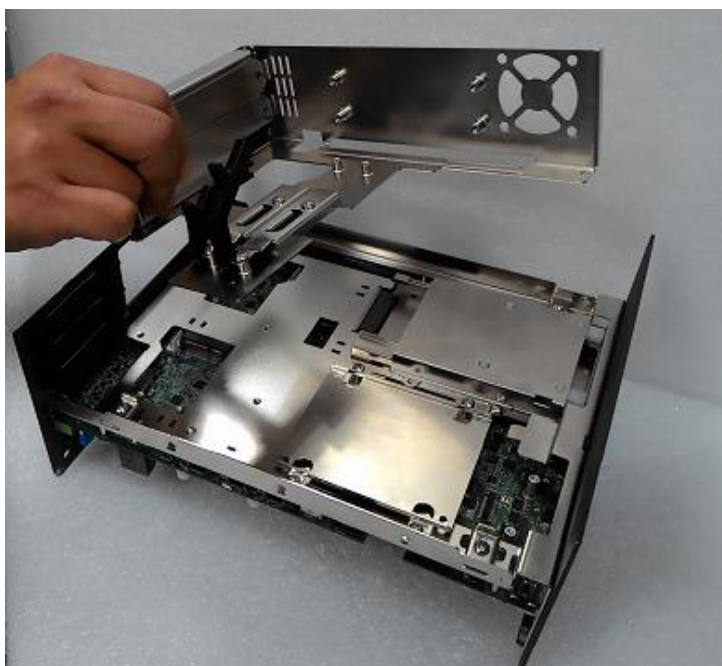

4. Assemble the riser card with extension bracket together and fasten with the 4 screws.

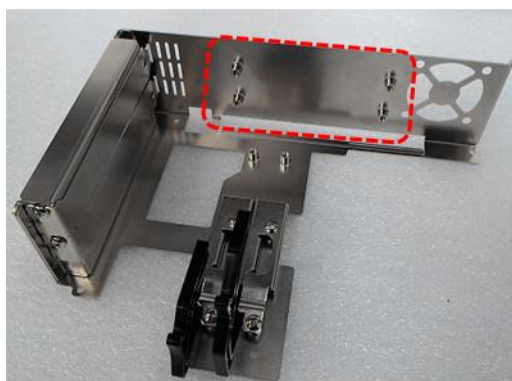

Extension Bracket

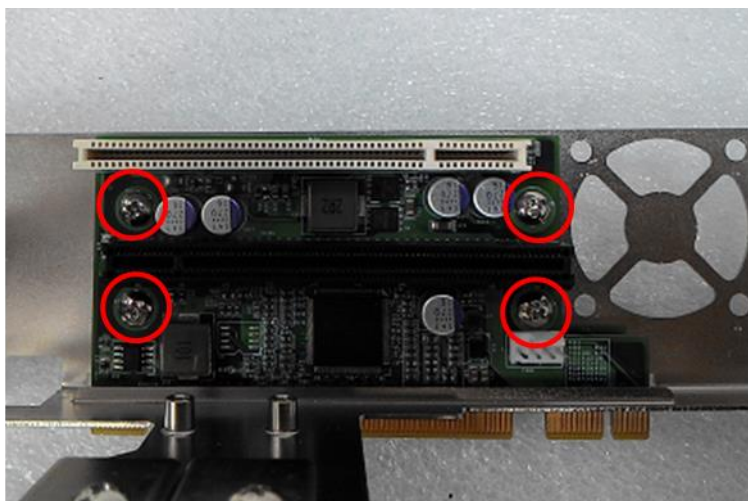



5. (1) Loosen the screw to remove I/O bracket. (2) Loosen the 2 screws halfway to allow the card retainer to be adjustable.

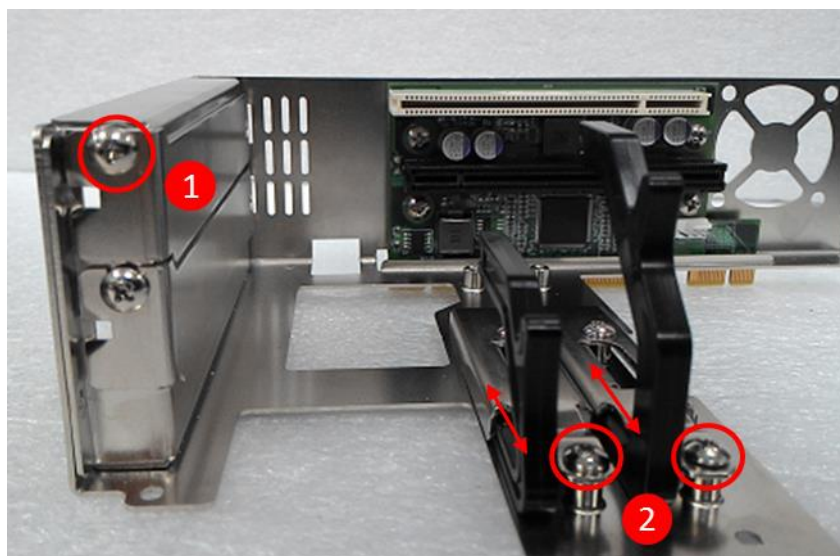

6. (1) Insert a PCI(e) add-on card to the slot. (2) Fasten the screw to secure it (3) Push the card retainer forward to against the edge of the add-on card. (4) Tighten the screw to fix the card retainer.

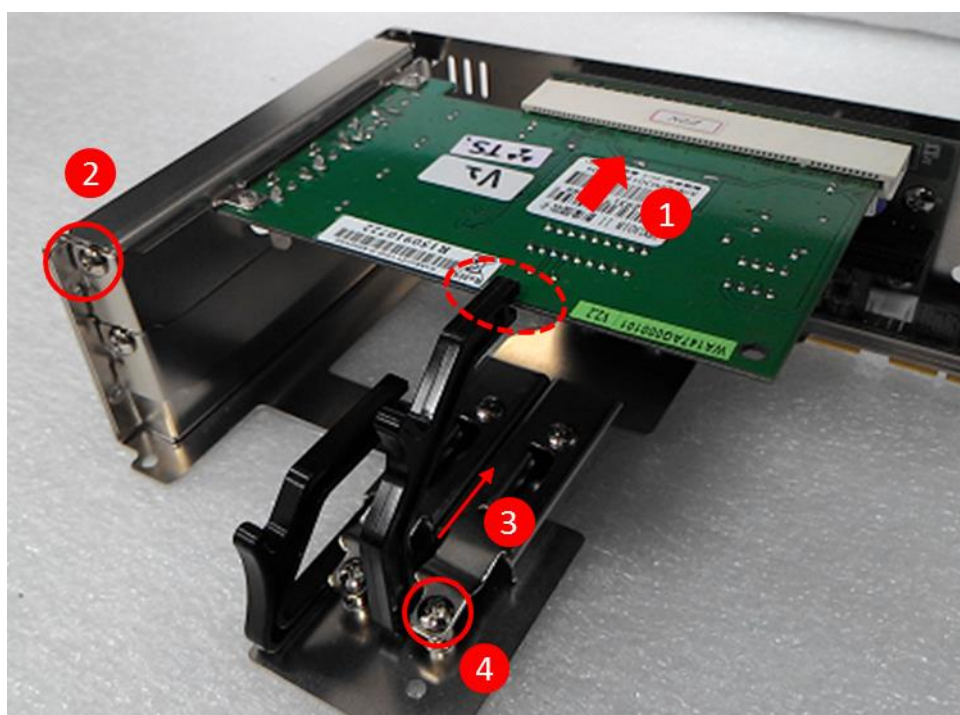

7. Locate the riser card slot on bottom side of system.

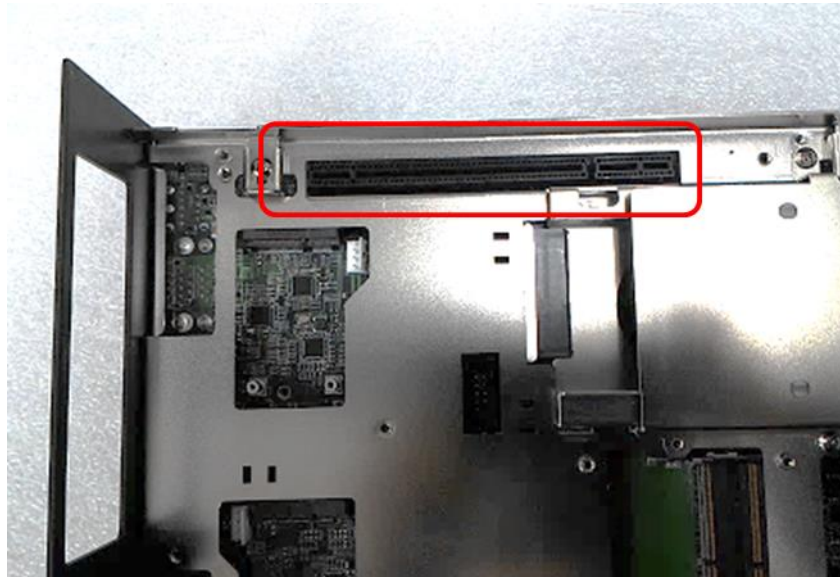

8. Install the module assembled in step 4 into the riser card slot, and fasten the 4 screws to secure it.



## 3.13 Assembling the System

1. Make sure the notch on chassis and the front bezel of body are at the same side.

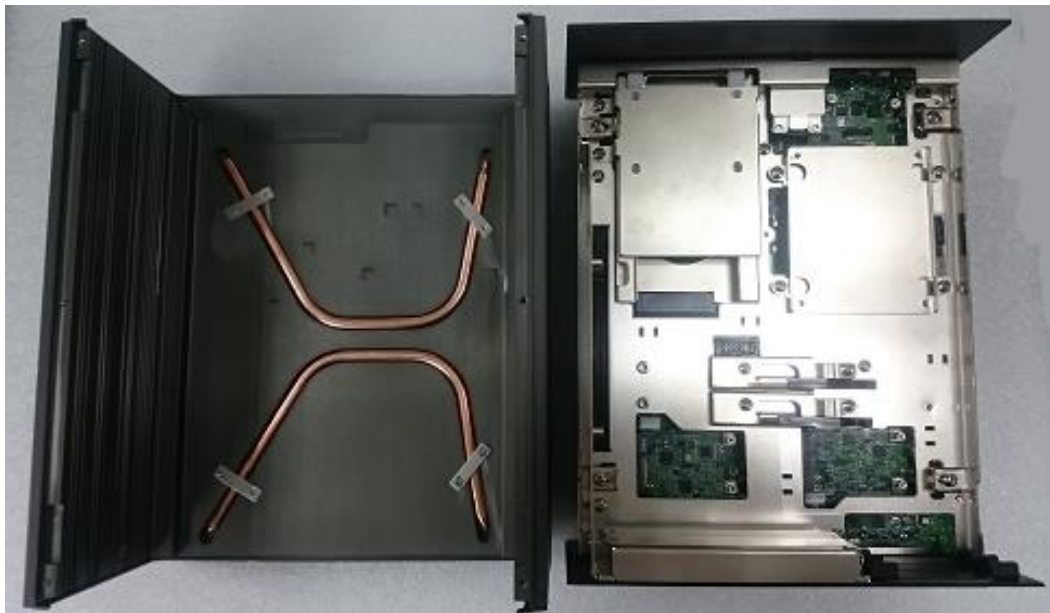

2. Lift up the body of unit. Make sure that both front and rear panels are in the chassis grooves and assemble the body on to chassis firmly.

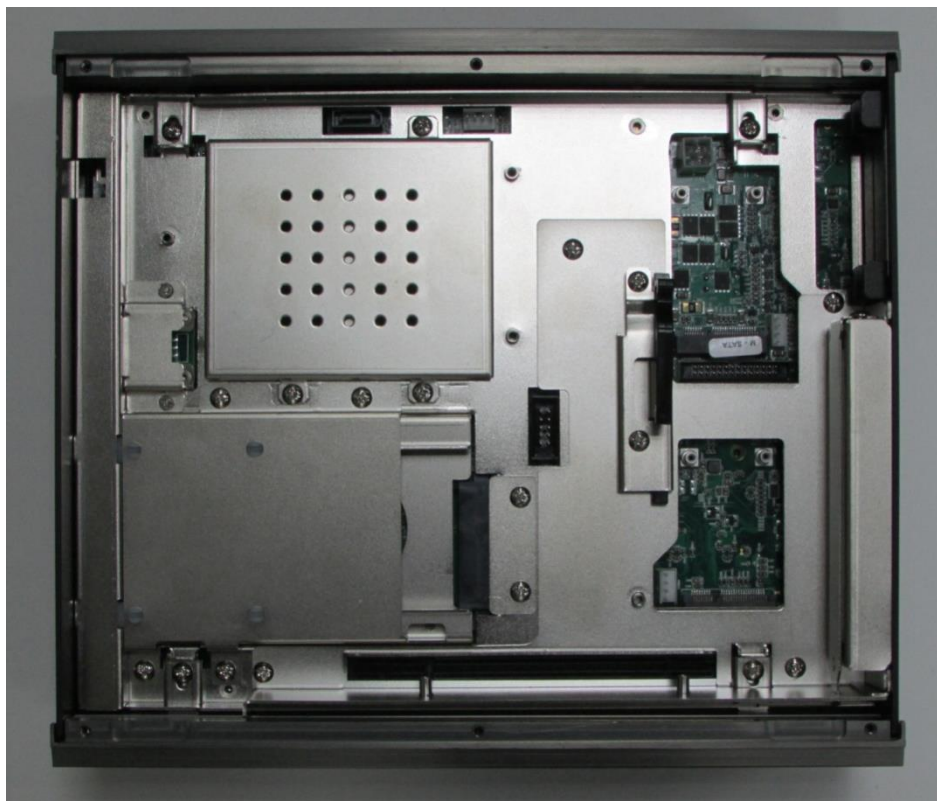

3. Push into the 4 latches as indicated and fasten the 4 screws.

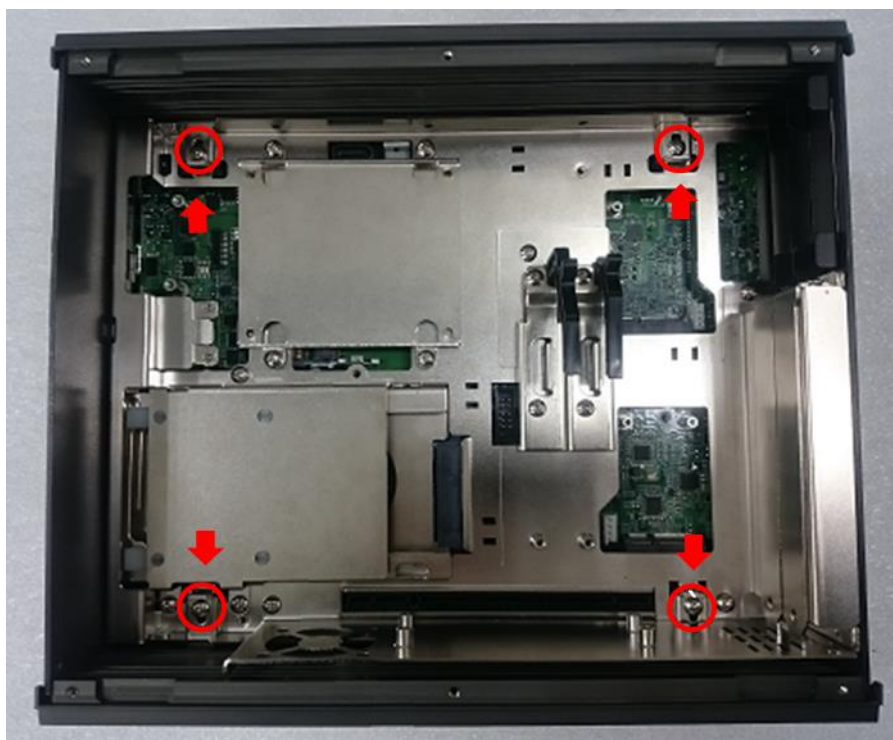

4. Fasten the 2 screws at rear panel.



5. Be sure to align the grooves with front and rear panels. Put the cover back on and fasten the 6 screws to fix the cover.



### 3.14 Installing a SATA Hard Drive at Front Side

1. Loosen the screws in order to remove the front expansion plate.



2. Locate the removable HDD bay and loosen the screw.



3. Move the rotating arm out and pull the HDD bracket out.



4. Make the PCB side of the HDD face up, place the HDD bracket into it. Ensure the direction of bracket is correct and use 4 provided screws to assemble HDD and HDD bracket together.



5. Align the HDD bracket with the entrance of HDD bay. Holding the rotating arm and insert the HDD bracket until the connector of HDD contact the SATA connector firmly.



6. Place the rotating arm back and fasten the screw.

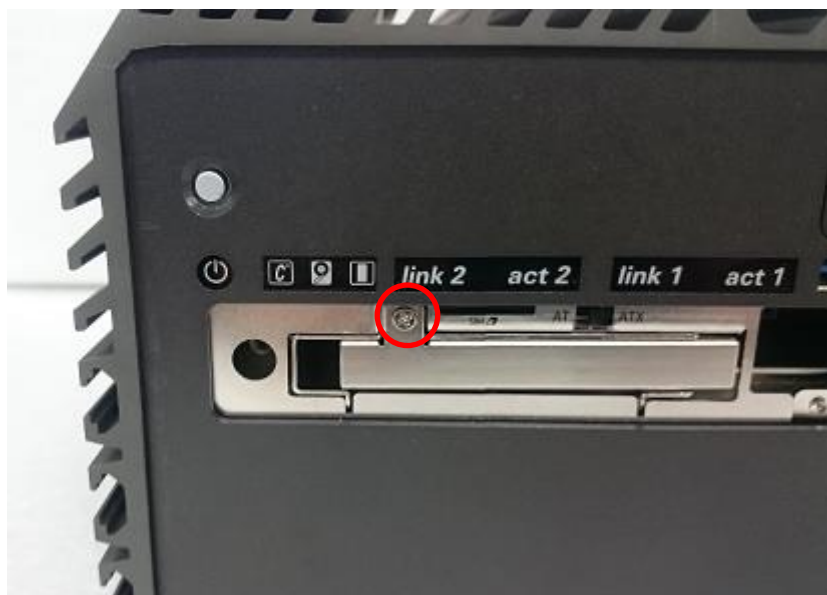



### 3.15 Installing a SIM Card

1. Locate the SIM card slot at front side.



2. Insert the SIM card according to the icon instruction aside.



## 3.16 Installing the CMOS Battery

1. Locate the removable CMOS Battery and loosen the screw.



2. Pull out the CMOS battery bracket with assistance of a tweezer.



3. Insert a CMOS battery in the battery slot.



4. Insert the battery bracket firmly and fasten the screw.



## 3.17 Fastening the Cover

1. Fasten the cover by using the two screws.



## 3.18 Installing an External Fan

1. Prepare an external fan. Loosen the 2 screws halfway on mounting frame before attempting to install it.

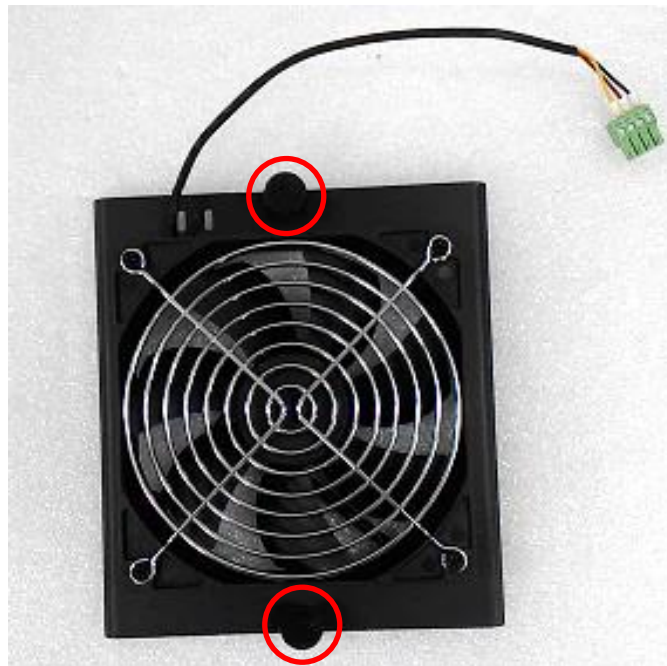

- Slide the FAN into the middle groove of chassis as illustrated. Tighten the 2 screws to fix it onto chassis.

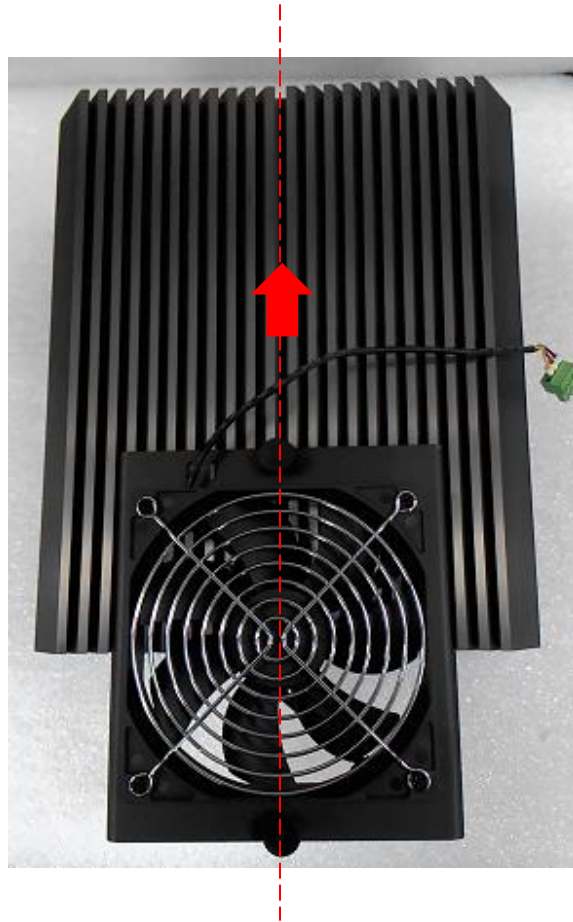

- Move the fan to the center of chassis. Tighten the 2 screws marked on photo to secure it.



4. Connect the FAN cable to external fan power connector at rear panel.



### 3.19 Wall Mount Brackets

DS-1100 series offers wall mount that customers can install system on the wall in convenient and economical ways.



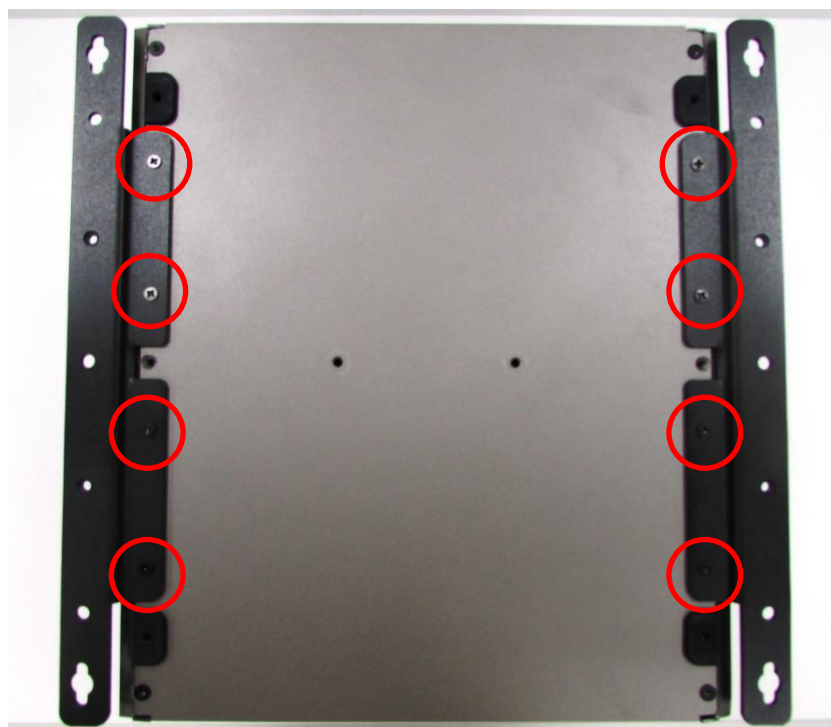

1. The mounting holes are at the bottom of system. Use provided 8 screws to fasten the bracket with each side of system together.

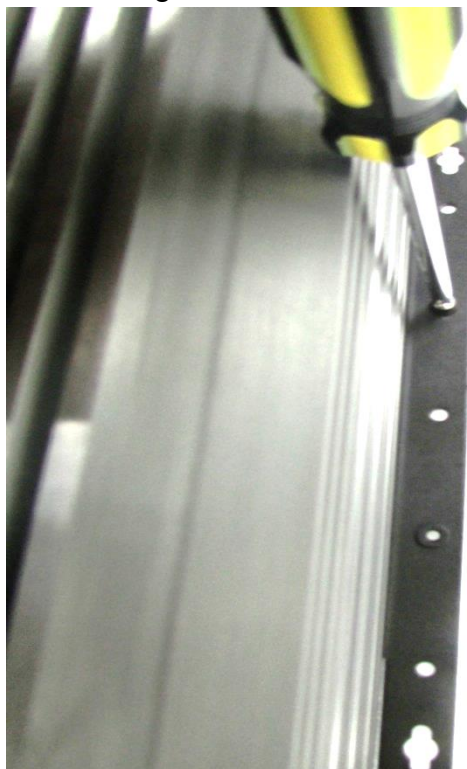

2. Fasten the screws through the bracket mounting hole to mount system on the wall.







# **Chapter 4**

## **BIOS Setup**

## 4.1 BIOS Introduction

The BIOS (Basic Input/ Output System) is a program located on a Flash Memory on the motherboard. When you start the computer, the BIOS program will gain control. The BIOS first operates an auto-diagnostic test called POST (power on self-test) for all the necessary hardware, it detects the entire hardware device and configures the parameters of the hardware synchronization.

### BIOS Setup

Power on the computer and by pressing <Del> immediately allows you to enter Setup. If the message disappears before your respond and you still wish to enter Setup, restart the system to try again by turning it OFF then ON or pressing <Ctrl>, <Alt> and <Delete> keys.

| Control Keys  |  |
|---------------|--|
| <←> <→>       | Move to select screen                        |
| <↑> <↓>       | Move to select item                          |
| <Esc>         | Quit the BIOS Setup                          |
| <Enter>       | Select item                                  |
| <Page Up/+>   | Increases the numeric value or makes changes |
| <Page Down/-> | Decreases the numeric value or makes changes |
| <Tab>         | Select setup fields                          |
| <F1>          | General help                                 |
| <F2>          | Previous value                               |
| <F3>          | Load Optimized defaults                      |
| <F10>         | Save configuration and Exit                  |

### Main Menu

The main menu lists the setup functions you can make changes to. You can use the arrow keys ( ↑↓ ) to select the item. The on-line description of the highlighted setup function is displayed at the bottom of the screen.

### Sub-Menu

If you find a right pointer symbol appears to the left of certain fields that means a sub-menu can be launched from this field. A sub-menu contains additional options for a field parameter. You can use arrow keys ( ↑↓ ) to highlight the field and press <Enter> to call up the sub-menu. Then you can use the control keys to enter values and move from field to field within a sub-menu. If you want to return to the main menu, just press the <Esc >.

## 4.2 Main Setup

Press <Del> to enter BIOS CMOS Setup Utility, the Main Menu (as shown below) will appear on the screen. Use arrow keys to move among the items and press <Enter> to accept or enter a sub-menu.

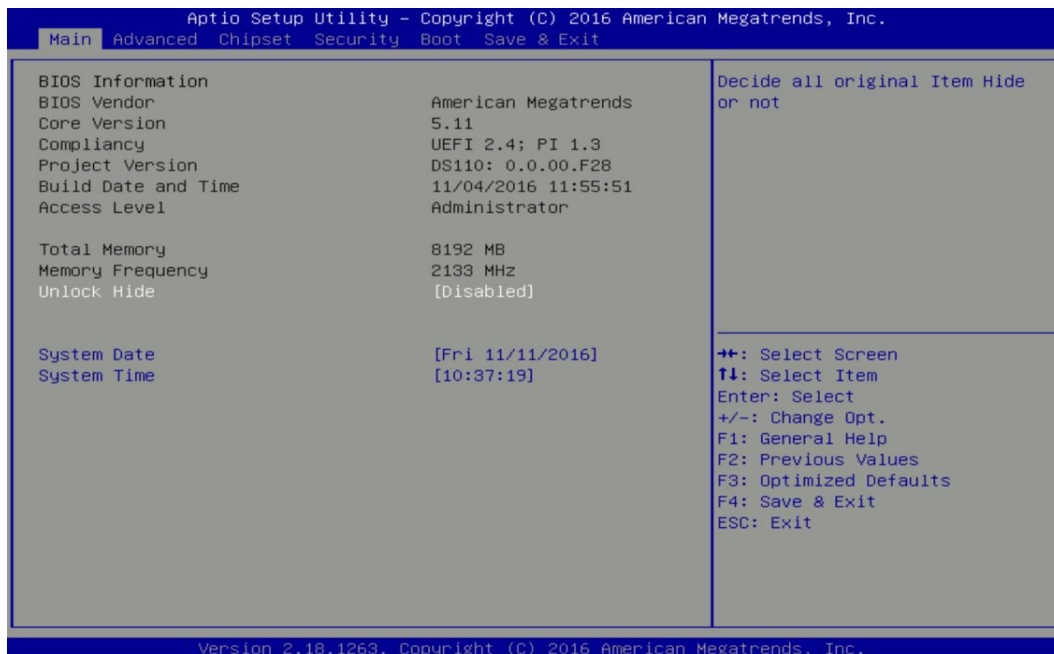

### 4.2.1 Unlock Hide [Disabled]

Enables or disables display detailed system hardware information.

### 4.2.2 System Date

Set the date. Please use <Tab> to switch between date elements.

### 4.2.3 System Time

Set the time. Please use <Tab> to switch between time elements.

## 4.3 Advanced Setup

This section allows you to configure and improve your system and allows you to set up some system features according to your preference.

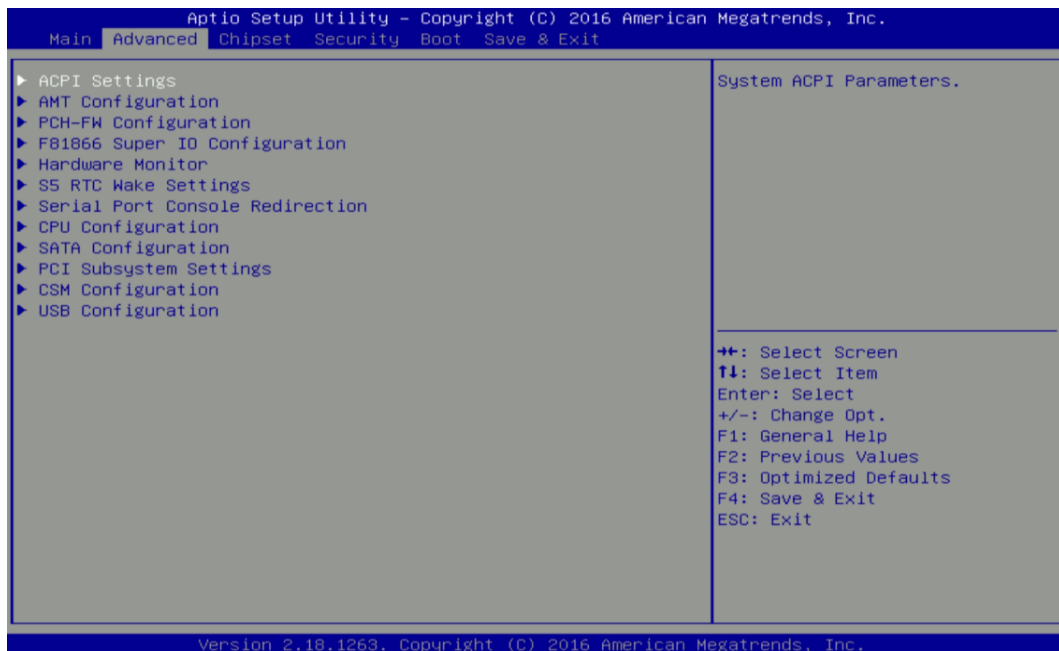

### 4.3.1 ACPI Settings

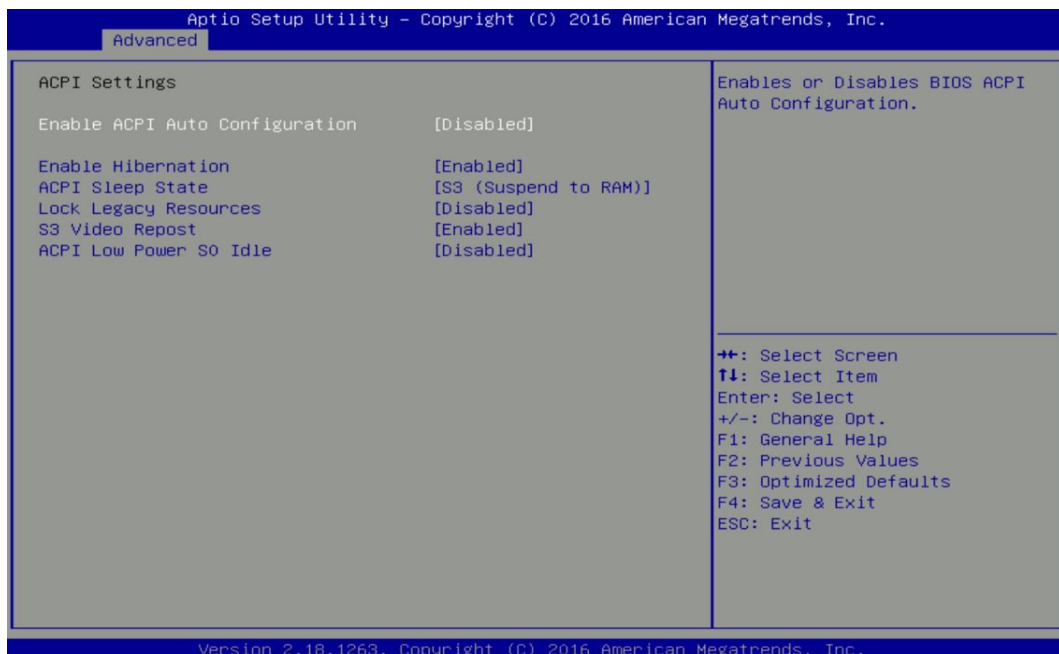

#### ■ Enable ACPI Auto Configuration [Disabled]

Enables or disables BIOS Advanced Configuration Power Interface® (ACPI) auto configuration.

#### ■ Enable Hibernation [Enabled]

Enables or disables system ability to hibernate state (OS/S4 state). This option may not be effective with some OS.

■ **ACPI Sleep State [S3 (Suspend to RAM)]**

Allows users to select the highest Advanced Configuration Power Interface® (ACPI) sleep state that system will enter when suspend button is pressed.

[Suspend Disabled]: Disables entering suspend state.

[S3 (suspend to RAM)]: Enables suspend to RAM state.

■ **Lock Legacy Resources [Disabled]**

Enables or disables Lock Legacy Resources.

■ **S3 Video Repost [Enabled]**

Enable or disable S3 Video Repost.

■ **ACPI Low Power S0 Idle [Disabled]**

Enables or disables ACPI Low Power S0 idle support.

**4.3.2 AMT Configuration**

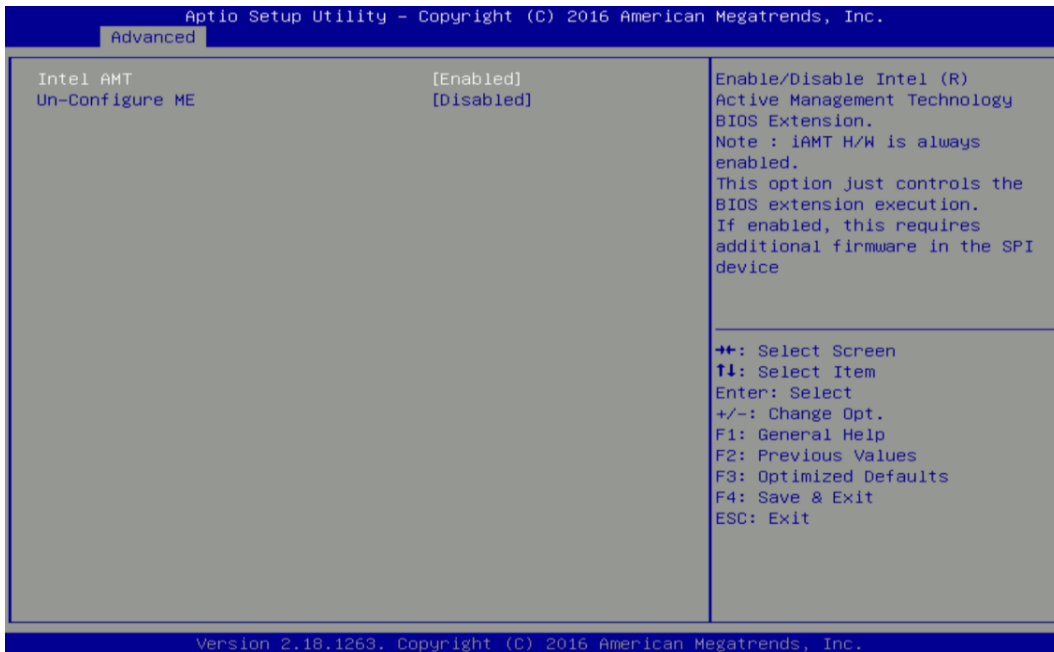

■ **Intel AMT [Enabled]**

Enables or disables Intel® Active Management Technology BIOS Extension.

■ **Un-Configure ME [Disabled]**

Enables or disables Un-Configure-Management Engine (ME) without password.

### 4.3.3 PCH-FW Configuration



#### ■ Firmware Update Configuration

Configure Management Engine Parameters

- Me FW Image Re-Flash [Disabled]**

Enables or disables Me FW Image Re-Flash function.

### 4.3.4 F81866 Super IO Configuration

Set Parameters of Serial Ports. User can Enable/Disable the serial port and Select an optimal setting for the Super IO Device.

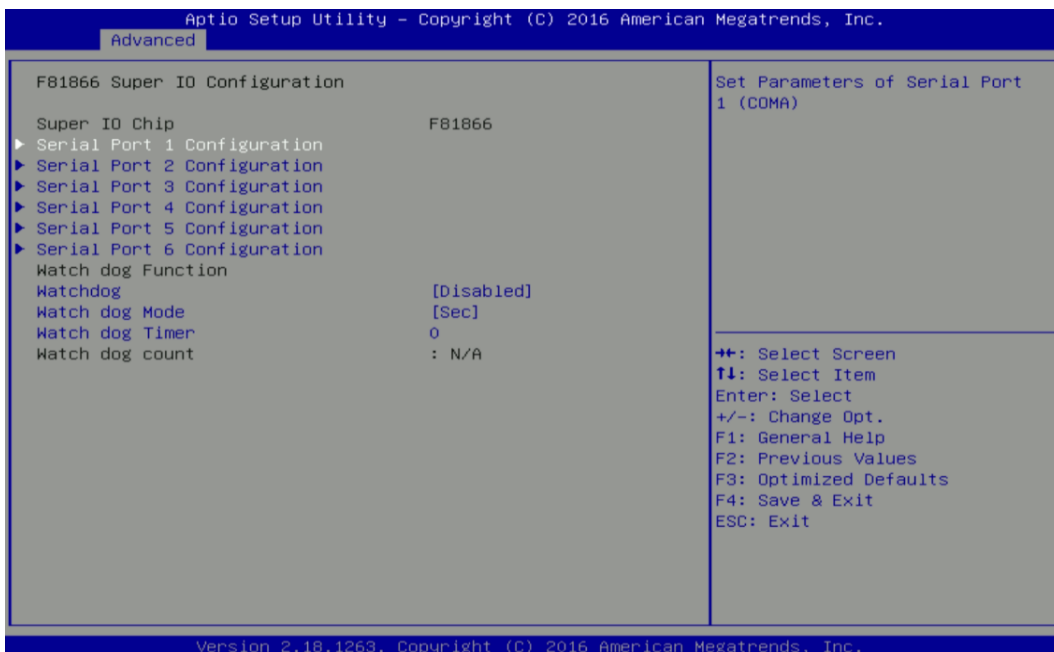

## ■ Serial Port 1~6 Configuration.

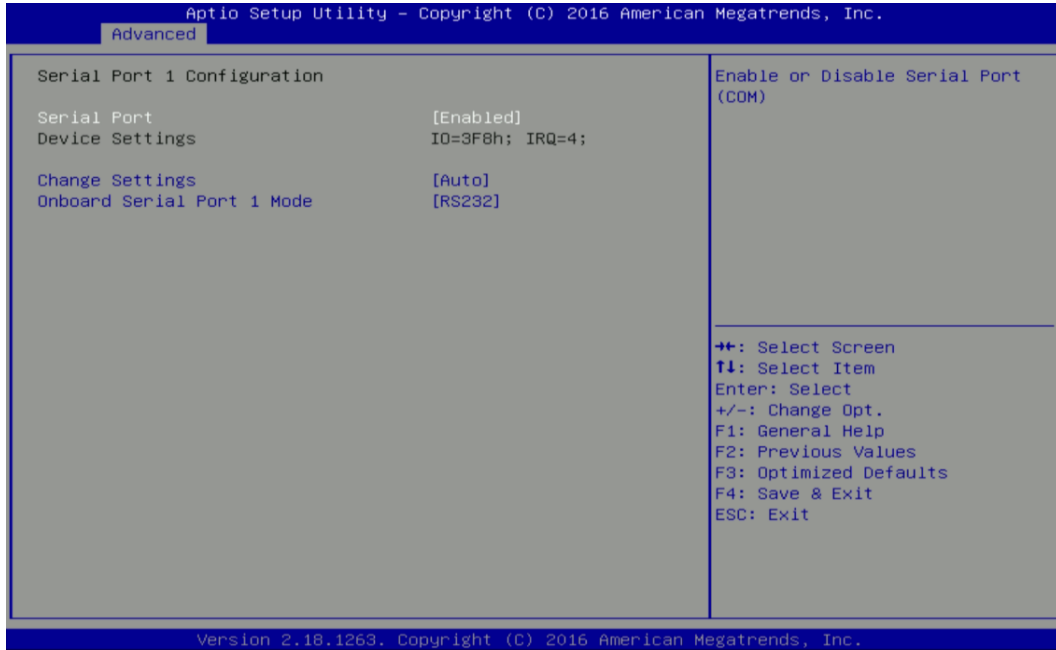

### Serial Port [Enabled]

Enables or disables serial port.

### Change Settings [Auto]

Allows you to change the IO Address & IRQ settings of the specified serial port.

### Onboard Serial Port 1~6 Mode [RS232]

Allows you to select Serial Port Mode.

Configuration options: [RS232] [RS422/RS485 Full Duplex] [RS485 Half Duplex]

## ■ Watch Dog [Disabled]

Enables or disables watch dog function.

### ■ Watch Dog Mode [Sec]

Allows to set watchdog timer unit <Sec> or <Min>.

### ■ Watch Dog Timer [0]

Allows you to set watchdog timer's value in the range of 0 to 255.

### 4.3.5 Hardware Monitor

This screen displays the current status of all monitored hardware devices/components such as voltages, temperatures and all fans' speeds.

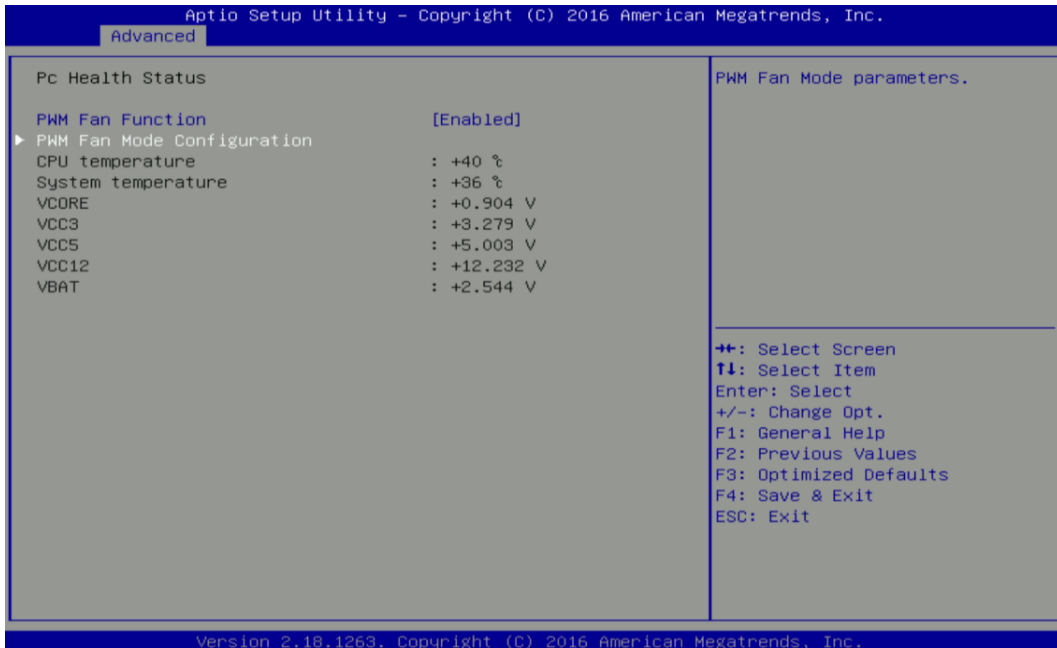

#### PC Health Status

##### ■ PWM Fan Function [Disabled]

Enables or disables PWM Fan function.

##### ■ PWM Fan Mode Configuration

###### PWM Fan1 Duty [60%]

This item allows users to change duty cycle value of PWM Fan1.

###### PWM Fan2 Duty [60%]

This item allows users to change duty cycle value of PWM Fan2.

### 4.3.6 S5 RTC Wake Settings

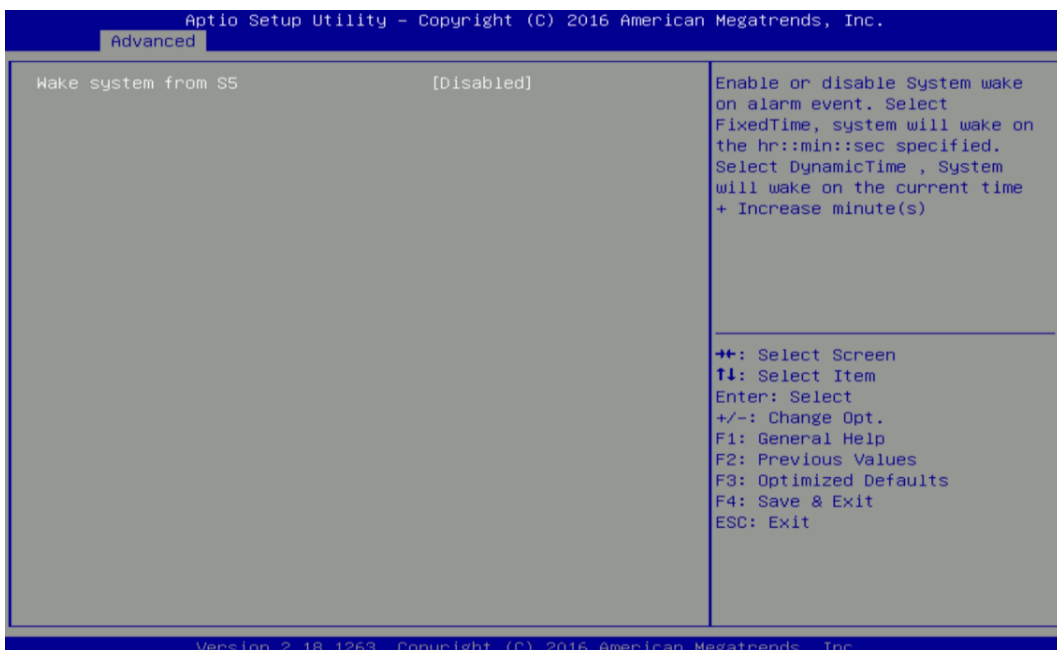



### ■ Wake system from S5 [Disabled]

Enables or disables wake system from S5 (soft-off state).

[Disabled]: Disables wake system from S5.

[Fixed Time]: Sets a fixed time (HH:MM:SS) to wake system from S5.

[Dynamic Time]: Sets an increase minute(s) from current time to wake system from S5.

### 4.3.7 Serial Port Console Redirection

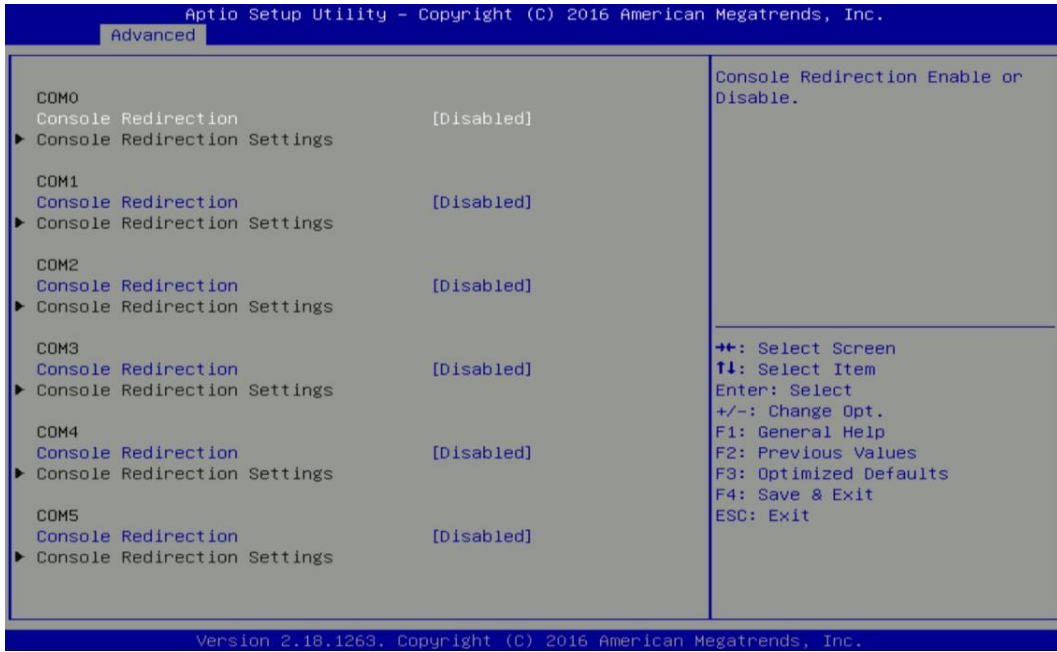

### ■ Console Redirection [Disabled]

These items allow users to enable or disable COM0, COM1, COM2, COM3, COM4, COM5 console redirection function.

### 4.3.8 CPU Configuration

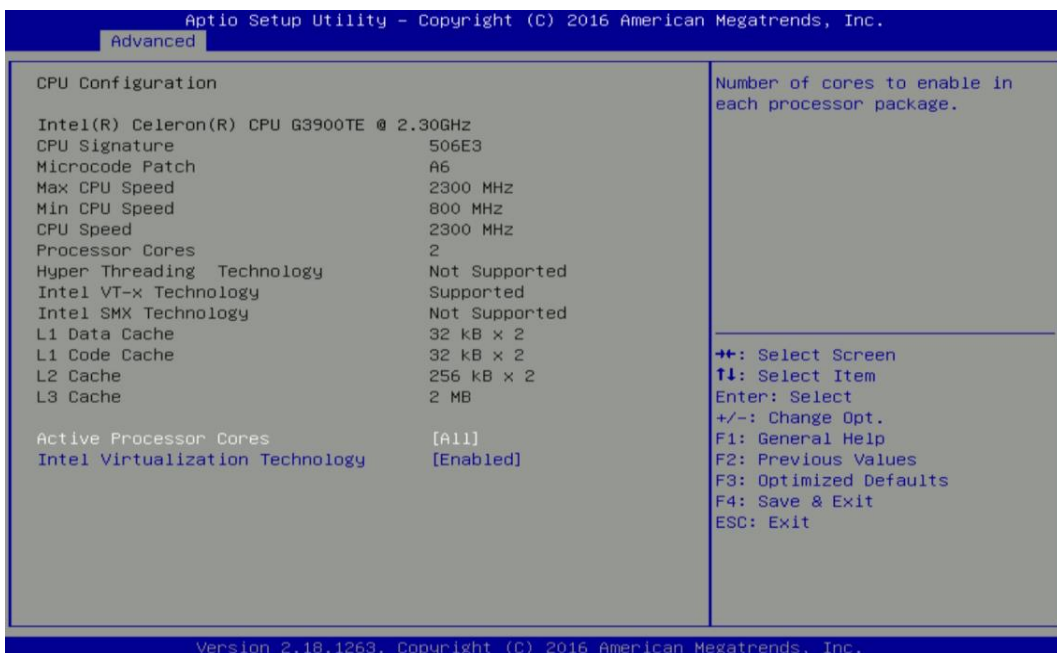

### ■ Active Process Cores [All]

Allows you to choose the number of active processor cores.

Configuration options: [All] [1].

### ■ Intel® Virtualization Technology [Enabled]

Enables or disables Intel® Virtualization Technology, which will allow a platform to run multiple operating systems and applications in independent partitions. With virtualization, one computer system can function as multiple virtual systems.

## 4.3.9 SATA Configuration

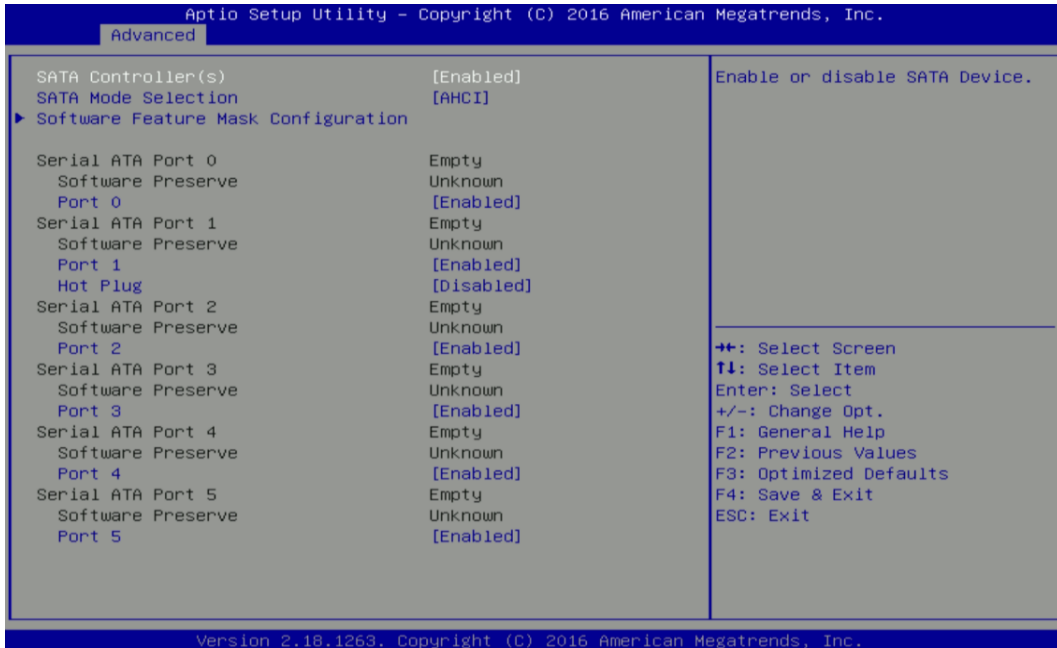

### ■ SATA Controller(s) [Enabled]

Enables or disables SATA device.

### ■ SATA Mode Selection [AHCI]

Allows you to select which mode SATA controller will operate.

Configuration options: [AHCI], [RAID]

## ■ Software Feature Mask Configuration

RAID option ROM (OROM) / Intel® Rapid Storage Technology (RST) driver will refer to the software feature configuration to enable or disable the storage features.

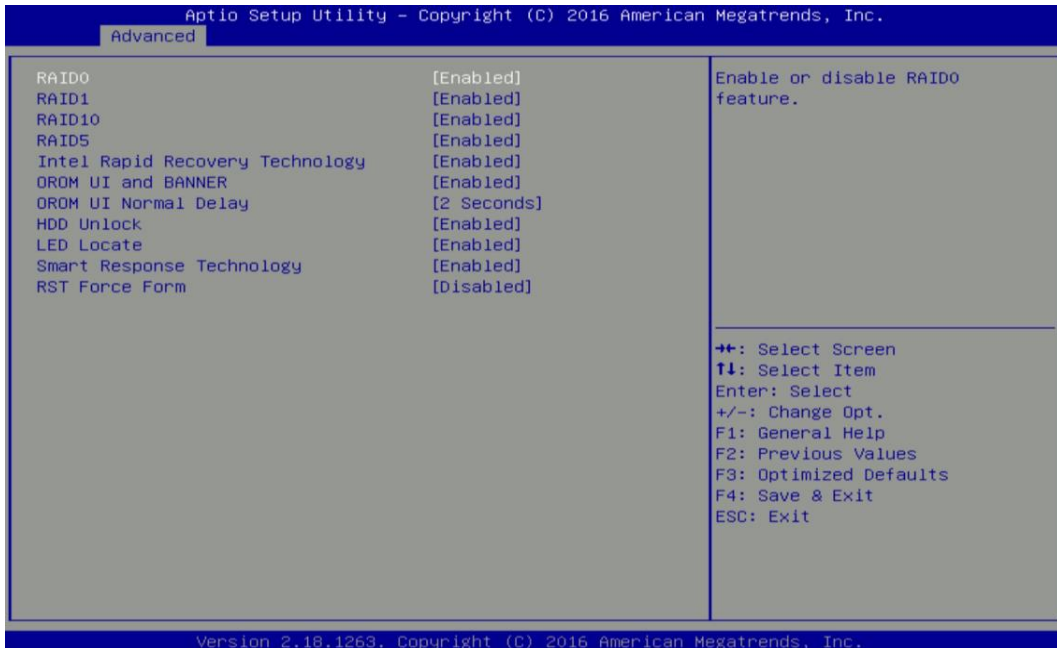

- RAID0 [Enabled]**  
Enables or disables RAID0 function.
- RAID1 [Enabled]**  
Enables or disables RAID1 function.
- RAID10 [Enabled]**  
Enables or disables RAID10 function.
- RAID5 [Enabled]**  
Enables or disables RAID5 function.
- Intel Rapid Recovery Technology [Enabled]**  
Enables or disables Intel® Rapid Recovery Technology.
- OROM UI and BANNER [Enabled]**  
Enables or disables OROM (Option ROM) UI and BANNER.
- OROM UI Normal Delay [2 Seconds]**  
Enables or disables OROM UI Normal Delay time in seconds.  
Configuration options: [2 Seconds] [4 Seconds] [6 Seconds] [8 Seconds]
- HDD Unlock [Enabled]**  
Enables or disables HDD Unlock.
- LED Locate [Enabled]**  
Enables or disables LED Locate.
- Smart Response Technology [Enabled]**  
Enables or disables Smart Response Technology.
- RST Force Form [Disabled]**  
Enables or disables RST (Intel® Storage Technology) Force Form.

## ■ Serial ATA Port 0

### Port 0 [Enabled]

Enables or disables SATA Port 0.

## ■ Serial ATA Port 1

### Port 1 [Enabled]

Enables or disables SATA Port 1.

### Hot Plug [Disabled]

Enables or disables Hot Plug support for port1.

## ■ Serial ATA Port 2

### Port 2 [Enabled]

Enables or disables SATA Port 2.

## ■ Serial ATA Port 3

### Port 3 [Enabled]

Enables or disables SATA Port 3.

## ■ Serial ATA Port 4

### Port 4 [Enabled]

Enables or disables SATA Port 4.

## ■ Serial ATA Port 5

### Port 5 [Enabled]

Enables or disables SATA Port 5.

## 4.3.10 PCI Subsystem Settings

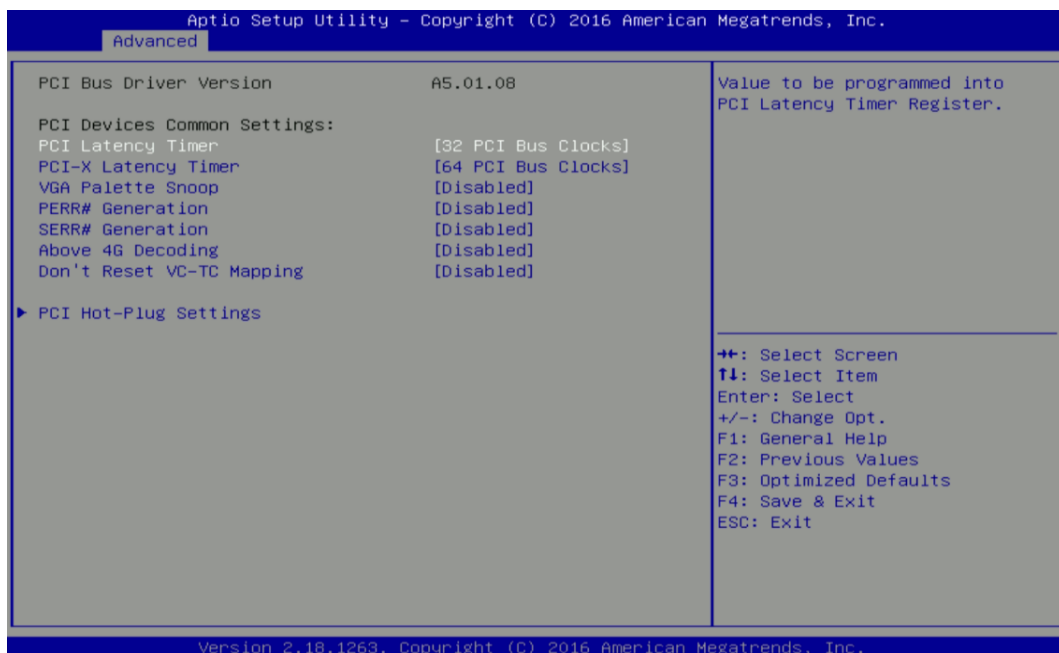

■ **PCI Latency Timer [32 PCI Bus Clocks]**

Allows you to set the value to be programmed into PCI latency Timer Register.  
Configuration options: [32][64][96][128][160][192][224][248] PCI Bus Clocks.

■ **PCI-X Latency Timer [64 PCI Bus Clocks]**

Allows you to set the value to be programmed into PCI latency Timer Register.  
Configuration options: [32][64][96][128][160][192][224][248] PCI Bus Clocks

■ **VGA Palette Snoop [Disabled]**

Enables or disables VGA palette registers snooping.

■ **PERR# Generation [Disabled]**

Enables or disables PCI device to generate PERR#.

■ **Above 4G Decoding [Disabled]**

Enables or disables 64bit capable devices to be decoded in above 4G address space.

■ **Don't Reset VC-TC Mapping [Disabled]**

Enables or disables software can reset traffic class mapping through virtual channels if system has virtual channels.

■ **PCI Hot-Plug Settings**



■ **BIOS Hot-Plug Support [Disabled]**

Enables or disables BIOS build in Hot-Plug support. Use this feature if OS does not support PCI Express and SHPC hot-plug natively.

■ **PCI Buses Padding [1]**

Allows users to set PCI Buses Padding.

Configuration options; [Disabled] [1] [2] [3] [4] [5]

■ **I/O Resources Padding [4K]**

Allows users to set I/O Resources Padding.

Configuration options; [Disabled] [4K] [8K] [16K] [32K]

### ■ MMIO 32 bit Resources Padding [16M]

Allows users to set I/O Resources Padding.

Configuration options; [Disabled] [1M] [2M] [4M] [8M] [16M] [32M] [64M] [128M]

### ■ PFMMIO 32 bit Resources Padding [16M]

Allows users to set I/O Resources Padding.

Configuration options; [Disabled] [1M] [2M] [4M] [8M] [16M] [32M] [64M] [128M]

## 4.3.11 CSM Configuration

This option controls legacy/UEFI ROMs priority.

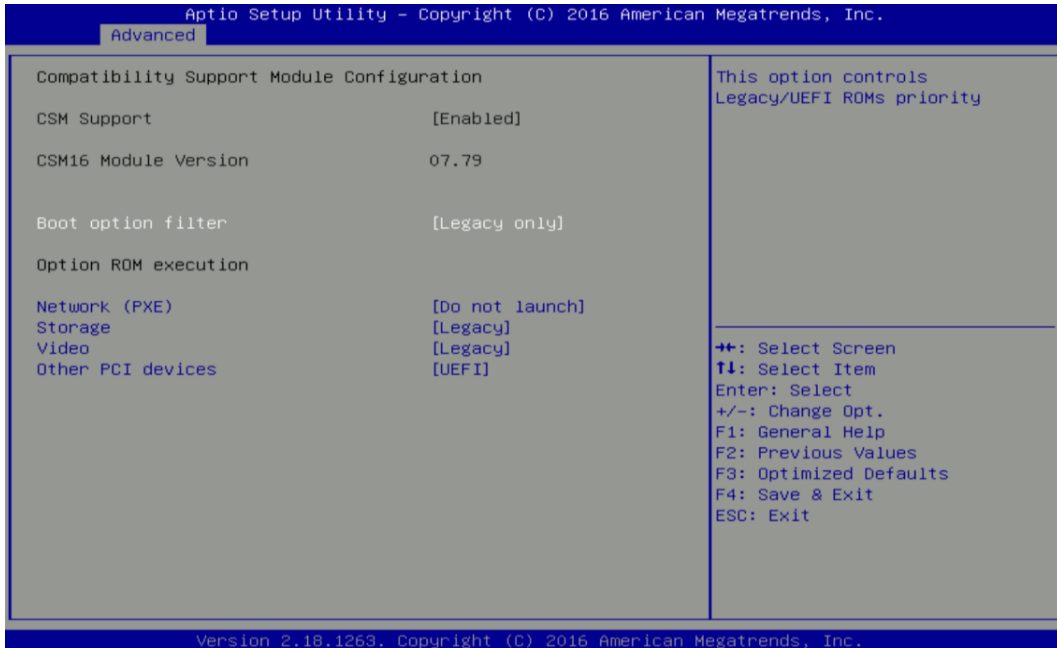

### Compatibility Support Module Configuration

This option controls legacy/UEFI ROMs priority

#### ■ Boot option filter [Legacy only]

Allows you to select which type of operating system to boot.

[UEFI and Legacy]: Allows booting from operating systems that support legacy option ROM or UEFI option ROM.

[Legacy only]: Allows booting from operating systems that only support legacy option ROM.

[UEFI only]: Allows booting from operating systems that only support UEFI option ROM.

**This item is configurable only when CSM Support is set to Enabled.**

#### ■ Network PXE [Do not launch]

Controls the execution of UEFI and Legacy PXE (Network Preboot eXecution Environment) option ROM.

[Do not launch]: Disables option ROM execution.

[UEFI]: Enables UEFI option ROM only.

[Legacy]: Enables legacy option ROM only.

#### ■ Storage [Legacy]

Controls the execution of UEFI and Legacy Storage option ROM.

[Do not launch]: Disables option ROM execution.

[UEFI]: Enables UEFI option ROM only.

[Legacy]: Enables legacy option ROM only.

### ■ Video [Legacy]

Controls the execution of UEFI and Legacy Video option ROM.

[Do not launch]: Disables option ROM execution.

[UEFI]: Enables UEFI option ROM only.

[Legacy]: Enables legacy option ROM only.

### ■ Other PCI devices [UEFI]

Allows users to determine option ROM execution policy for device other than network, storage, or video.

## 4.3.12 USB Configuration

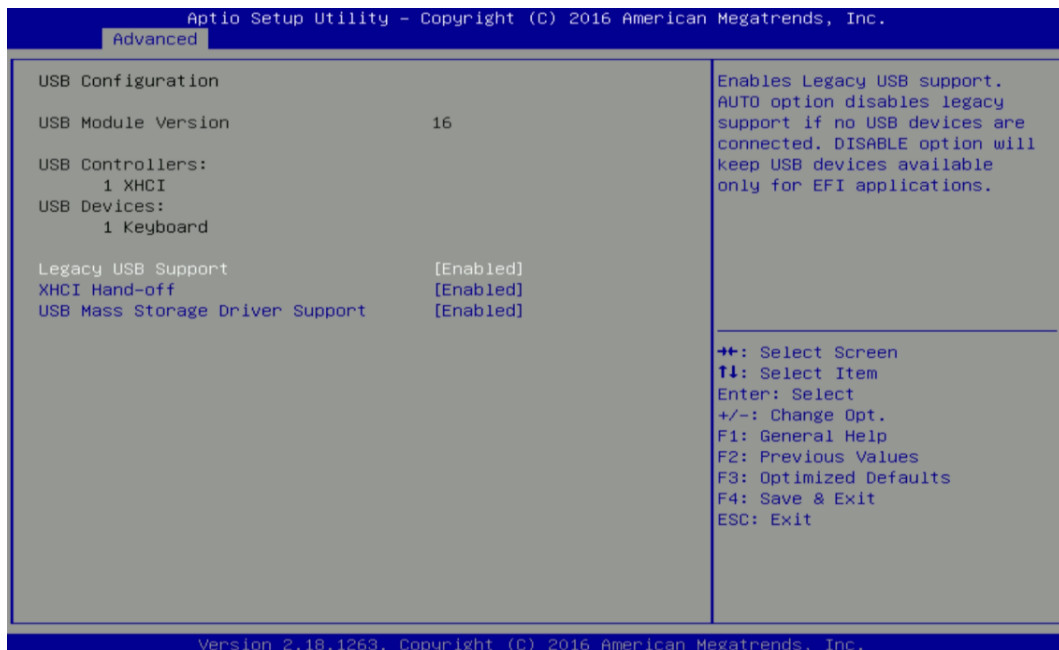

### ■ Legacy USB Support [Enabled]

This item allows users to enable or disable legacy USB support. When set to [Auto], legacy USB support will be disabled automatically if no USB devices are connected.

### ■ XHCI Hand-off [Enabled]

Enables or disables XHCI (USB3.0) hand-off function. Use this feature as a workaround for operating systems without XHCI hand-off support.

### ■ USB Mass Storage Driver Support [Enabled]

Enables or disables USB mass storage driver support.

## 4.4 Chipset Setup

This section allows you to configure chipset related settings according to user's preference.

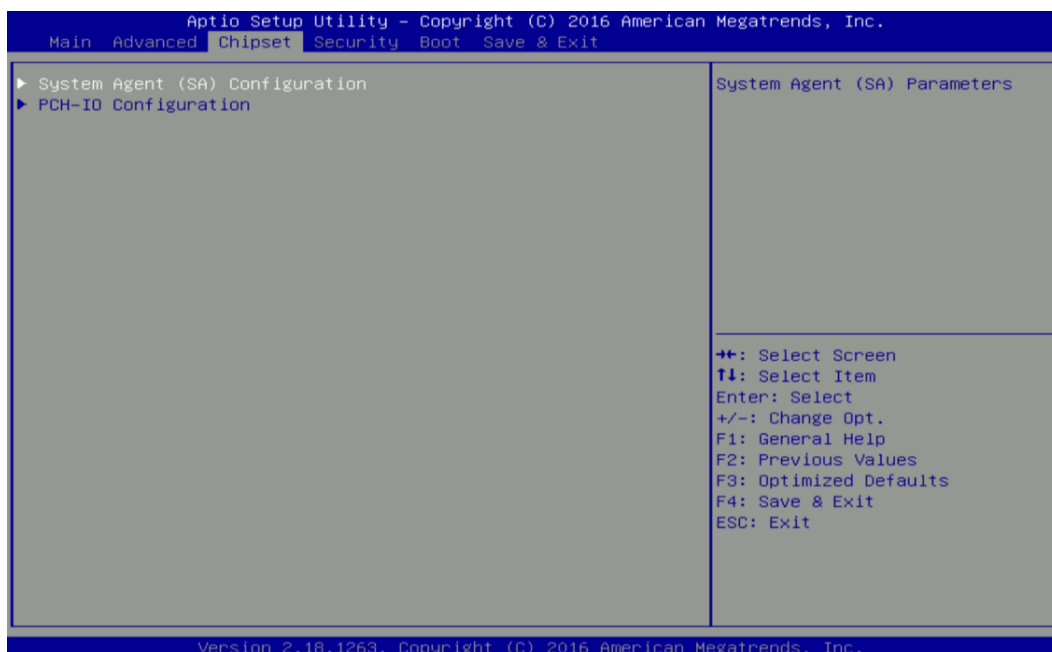

### 4.4.1 System Agent (SA) Configuration

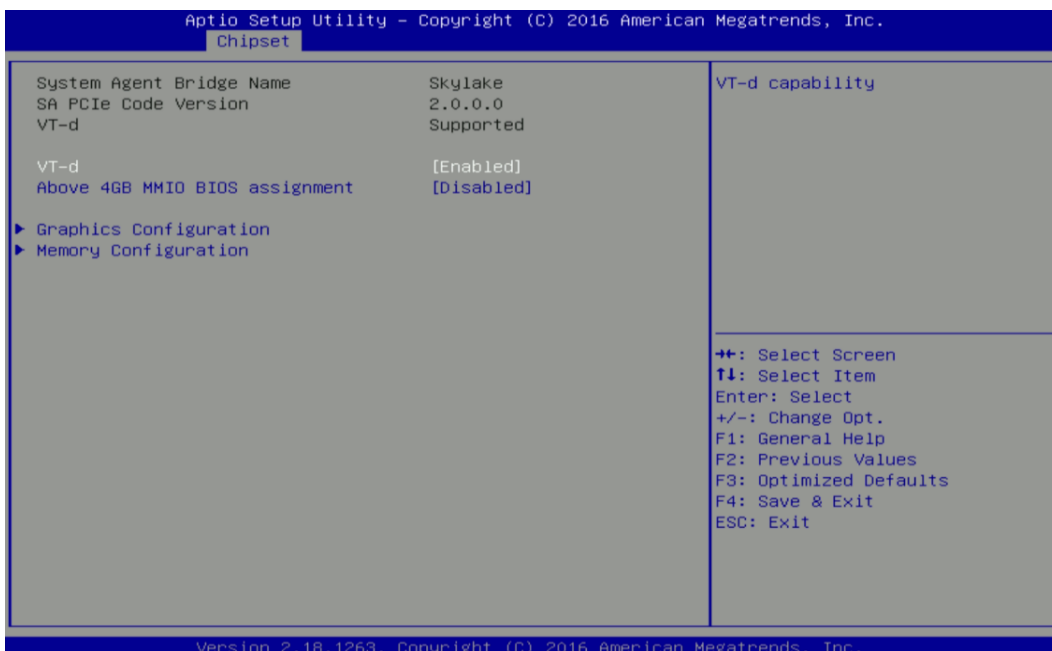

#### ■ VT-d [Enabled]

Enables or disables Intel® Virtualization Technology for Directed I/O (VT-d) capability.

#### ■ Above 4GB MMIO BIOS assignment [Disabled]

Enables or disables Above 4GB Memory Mapped IO BIOS assignment. This is disabled automatically when Aperture Size is set to 2048MB.



## ■ Graphics Configuration

### ❑ Primary Display [Auto]

Allows users to select which graphics device should be primary display or select SG for switchable graphics.

Configuration options: [Auto] [IGFX] [PEG] [PCIE]

### ❑ Internal Graphics [Auto]

Allows users to enable or disable Internal Graphics.

Configuration options: [Auto] [Disabled] [Enabled]

## ■ Memory Configuration

This item displays detailed memory information in the system.

### 4.4.2 PCH-IO Configuration

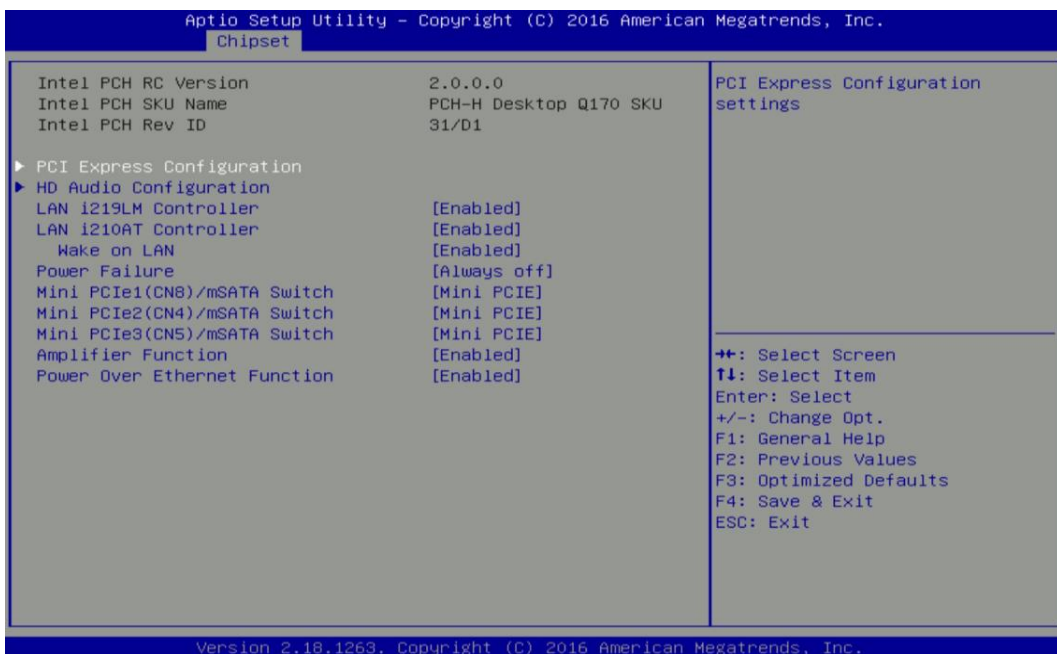

## ■ PCI Express Configuration

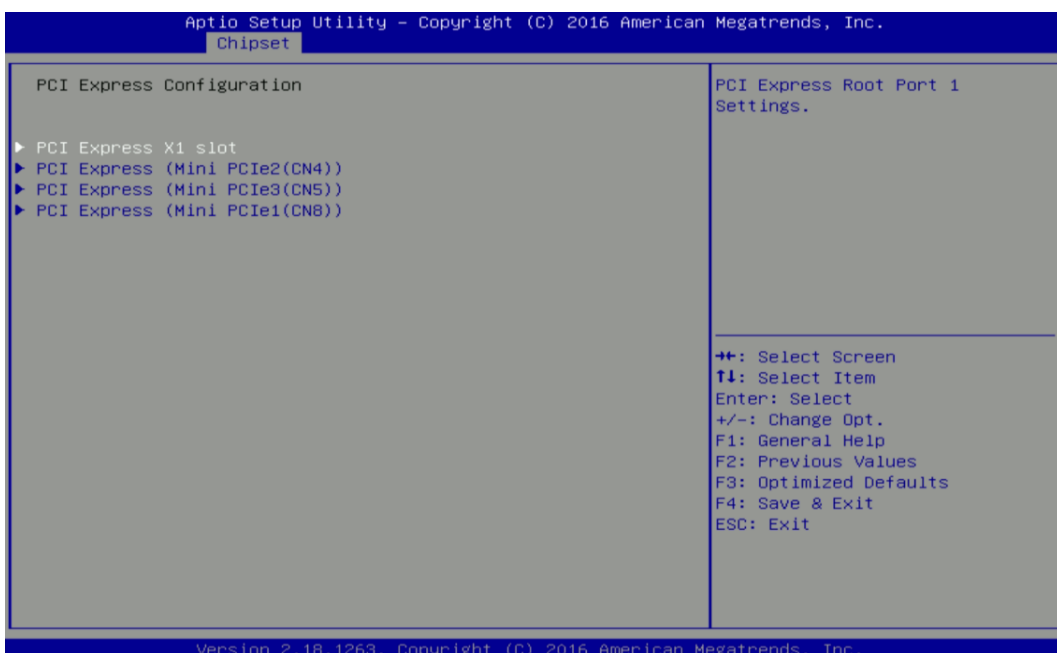

### **PCI Express x1 Slot**

**PCI Express Root Port 1 [Enabled]**

Enables or disables PCI Express Root Port 1.

**PCleSpeed [Auto]**

Allows you to select PCI Express port speed.

Configuration options: [Auto] [Gen1] [Gen2] [Gen3].

### **PCI Express (Mini PCIe2(CN4))**

**PCI Express Root Port 2 [Enabled]**

Enables or disables PCI Express Root Port 2.

Configuration options: [Auto] [Gen1] [Gen2] [Gen3].

### **PCI Express (Mini PCIe2(CN5))**

**PCI Express Root Port 3 [Enabled]**

Enables or disables PCI Express Root Port 3.

Configuration options: [Auto] [Gen1] [Gen2] [Gen3].

### **PCI Express (Mini PCIe2(CN8))**

**PCI Express Root Port 4 [Enabled]**

Enables or disables PCI Express Root Port 4.

Configuration options: [Auto] [Gen1] [Gen2] [Gen3].

### **HD Audio Configuration**

**HD Audio [Auto]**

Control detection of the HD-Audio device.

Configuration options: [Disabled]:[Enabled] [Auto]

### **LAN i219LM Controller [Enabled]**

Enables or disables i219LM LAN Controller.

### **LAN i210AT Controller [Enabled]**

Enables or disables I210 LAN Controller.

### **Wake on LAN [Enabled]**

Enables or disables integrated LAN Wake On LAN function.

### **Power Failure [Always off]**

Allows you to specify what power state system will enter when power is resumed after a power failure.

[Always on]: Enters to power on state.

[Always off]: Enters to power off state.

[Keep last state]: Enters to the last power state before a power failure.

### **Mini PCIe1(CN8)/mSATA Switch [Min PCIE]**

Allows you to switch to Mini PCIe or mSATA interface for CN8 slot.

### **Mini PCIe2(CN4)/mSATA Switch [Min PCIE]**

Allows you to switch to Mini PCIe or mSATA interface for CN4 slot.

### **Mini PCIe3(CN5)/mSATA Switch [Min PCIE]**

Allows you to switch to Mini PCIe or mSATA interface for CN5 slot.

### **Amplifier Function [Enabled]**

Enables or disables Amplifier Function.

### ■ Power Over Ethernet Function [Enabled]

Enables or disables Power Over Ethernet Function.

## 4.5 Security Setup

This section allows users to configure BIOS security settings.

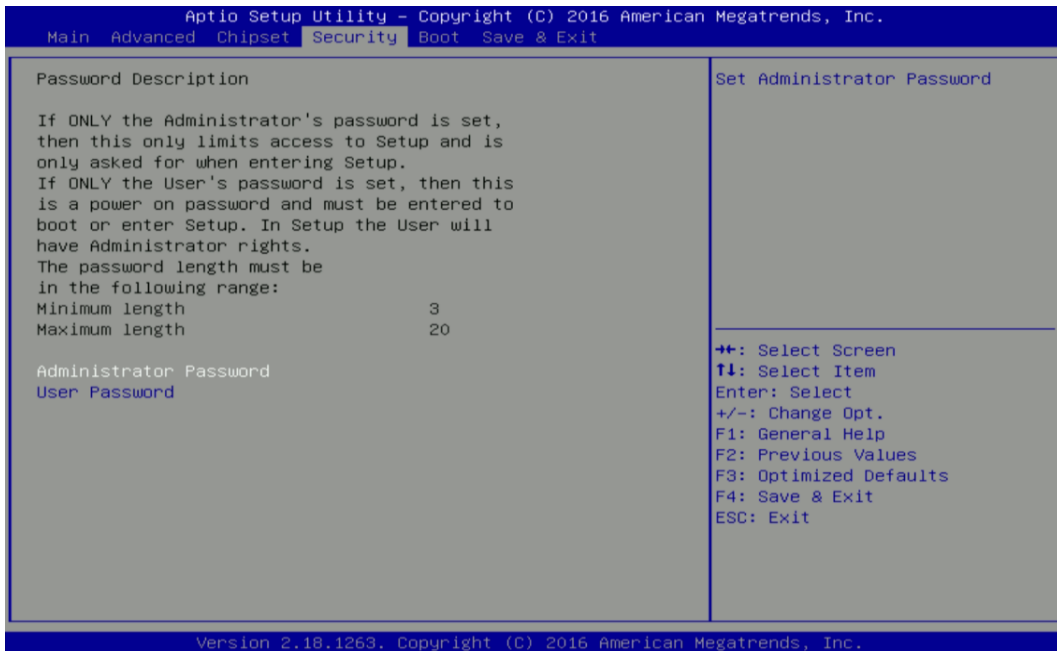

### 4.5.1 Administrator Password

Administrator Password controls access to the BIOS Setup utility.

### 4.5.2 User Password

User Password controls access to the system at boot and to the BIOS Setup utility.

## 4.6 Boot Setup

This section allows you to configure Boot settings.

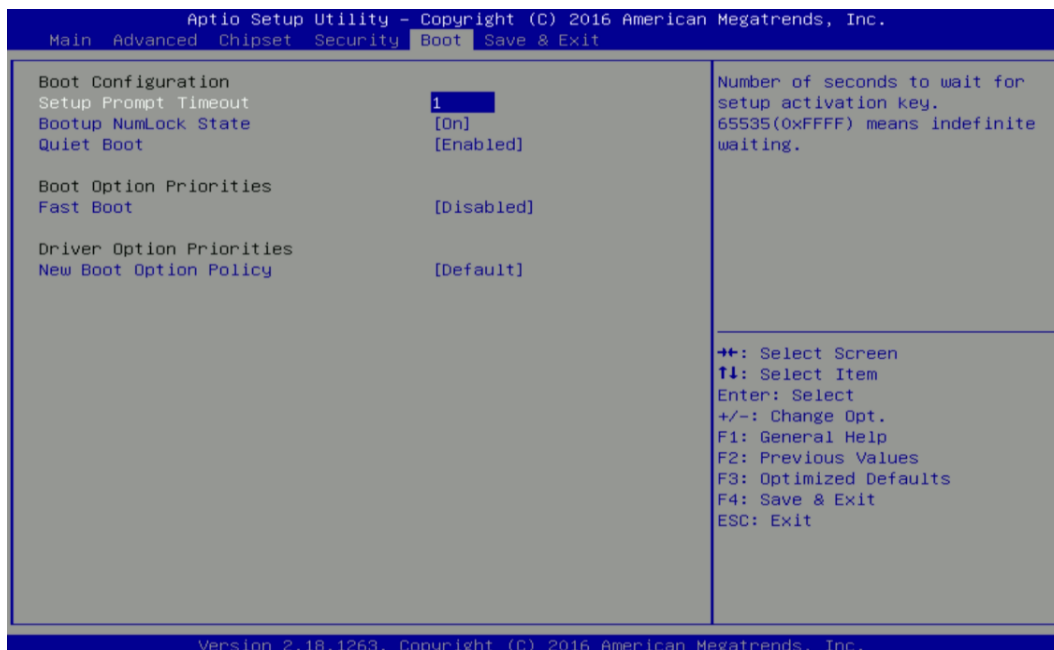

### 4.6.1 Setup Prompt Timeout [1]

Use this item to set number of seconds (1..65535) to wait for setup activation key.

### 4.6.2 Bootup NumLock State [On]

Allows you to set NumLock key to <On> or <Off> state when system boots up.

### 4.6.3 Quiet Boot [Enabled]

Allows you to enable or disable Quiet Boot function.

### 4.6.4 Fast Boot [Disabled]

Allows you to enable or disable Fast Boot function. If enabled, system boots with initialization of a minimal set of devices required to launch active boot option.

### 4.6.5 New Boot Option Policy [Default]

Allows you to change New Boot Option Policy.

Configuration options: [Default] [Place First] [Place Last].

## 4.7 Save & Exit



### 4.7.1 Save Changes and Exit

This item allows you to exit system setup after saving changes.

### 4.7.2 Discard Changes and Exit

This item allows you to exit system setup without saving changes.

### 4.7.3 Save Changes and Reset

This item allows you to reset the system after saving changes.

### 4.7.4 Discard Changes and Reset

This item allows you to reset system setup without saving any changes.

### 4.7.5 Save Changes

This item allows you to save changes done so far to any of the setup options.

### 4.7.6 Discard Changes.

This item allows you to discard changes done so far to any of the setup options.

### 4.7.7 Restore Defaults

This item allows you to restore/ load default values for all the setup options.

### 4.7.8 Save as User Defaults

This item allows you to save the changes done so far as user defaults.

### 4.7.9 Restore User Defaults

This item allows you to restore the user defaults to all the setup options.



# **Chapter 5**

## **Product Application**

**(For CMI-CD, CMI-ICD only)**

## 5.1 Digital I/O (DIO) application

This section describes DIO application of the product. The content and application development are better understood and implemented by well experienced professionals or developers.

### 5.1.1 Digital I/O Programming Guide

#### 5.1.1.1 Pins for Digital I/O

| Item            | Standard |
|-----------------|----------|
| GPIO74 (Pin107) | DI       |
| GPIO75 (Pin108) |          |
| GPIO76 (Pin109) |          |
| GPIO77 (Pin110) |          |
| GPIO80 (Pin111) | DO       |
| GPIO81 (Pin112) |          |
| GPIO82 (Pin113) |          |
| GPIO83 (Pin114) |          |

### 5.1.1.2 Programming Guide

To program the Super I/O chip F81866A configuration registers, the following configuration procedures must be followed in sequence:

- (1) Enter the Extended Function Mode
- (2) Configure the configuration registers
- (3) Exit the Extended Function Mode

The configuration register is used to control the behavior of the corresponding devices. To configure the register, use the index port to select the index and then write data port to alter the parameters. The default index port and data port are 0x4E and 0x4F, respectively.

**Pull down the SOUT1 pin to change the default value to 0x2E/ 0x2F. To enable configuration, the entry key 0x87 must be written to the index port. To disable configuration, write exit entry key 0xAA to the index port.**

Following is an example to enable configuration and to disable configuration by using debug.

- o 4e 87
- o 4e 87 (enable configuration)
- o 4e aa (disable configuration)

### 5.1.1.3 Relative Registers

To program the F81866A configuration registers, see the following configuration procedures.

**Logic Device Number Register (LDN) — Index 07h**

| Bit | Name | R/W | Reset   | Default | Description  |
|-----|------|-----|---------|---------|--|
| 7-0 | LDN  | R/W | LRESET# | 00h     | 00h: Select FDC device configuration registers.<br>03h: Select Parallel Port device configuration registers.<br>04h: Select Hardware Monitor device configuration registers.<br>05h: Select KBC device configuration registers.<br><b>06h: Select GPIO device configuration registers.</b><br>07h: Select WDT device configuration registers.<br>0Ah: Select PME, ACPI and ERP device configuration registers.<br>10h: Select UART1 device configuration registers.<br>11h: Select UART2 device configuration registers.<br>12h: Select UART3 device configuration registers.<br>13h: Select UART4 device configuration registers.<br>14h: Select UART5 device configuration registers.<br>15h: Select UART6 device configuration registers.<br>Otherwise: Reserved. |

**7.7.11.1GPIO7 Output Enable Register — Index 80h**

| Bit | Name      | R/W | Reset   | Default | Description   |
|-----|-----------|-----|---------|---------|---|
| 7   | GPIO77_OE | R/W | LRESET# | 0       | 0: GPIO77 is in input mode.<br>1: GPIO77 is in output mode. |
| 6   | GPIO76_OE | R/W | LRESET# | 0       | 0: GPIO76 is in input mode.<br>1: GPIO75 is in output mode. |
| 5   | GPIO75_OE | R/W | LRESET# | 0       | 0: GPIO75 is in input mode.<br>1: GPIO75 is in output mode. |
| 4   | GPIO74_OE | R/W | LRESET# | 0       | 0: GPIO74 is in input mode.<br>1: GPIO74 is in output mode. |



7.7.11.3GPIO7 Pin Status Register — Index 82h (This byte could be also read by base address + 3)

| Bit | Name      | R/W | Reset | Default | Description                     |
|-----|-----------|-----|-------|---------|---------------------------------|
| 7   | GPIO77_IN | R   | -     | -       | The pin status of GPIO77/STB#.  |
| 6   | GPIO76_IN | R   | -     | -       | The pin status of GPIO76/AFD#.  |
| 5   | GPIO75_IN | R   | -     | -       | The pin status of GPIO75/ERR#.  |
| 4   | GPIO74_IN | R   | -     | -       | The pin status of GPIO74/INIT#. |

7.7.12.1GPIO8 Output Enable Register — Index 88h

|   |           |     |         |   |   |
|---|-----------|-----|---------|---|---|
| 3 | GPIO83_OE | R/W | LRESET# | 1 | 0: GPIO83 is in input mode.<br>1: GPIO83 is in output mode. |
| 2 | GPIO82_OE | R/W | LRESET# | 1 | 0: GPIO82 is in input mode.<br>1: GPIO82 is in output mode. |
| 1 | GPIO81_OE | R/W | LRESET# | 1 | 0: GPIO81 is in input mode.<br>1: GPIO81 is in output mode. |
| 0 | GPIO80_OE | R/W | LRESET# | 1 | 0: GPIO80 is in input mode.<br>1: GPIO80 is in output mode. |

7.7.12.2GPIO8 Output Data Register — Index 89h (This byte could be also written by base address + 2)

|   |            |     |         |   |  |
|---|------------|-----|---------|---|--|
| 3 | GPIO83_VAL | R/W | LRESET# | 1 | 0: GPIO83 outputs 0 when in output mode.<br>1: GPIO83 outputs 1 when in output mode. |
| 2 | GPIO82_VAL | R/W | LRESET# | 1 | 0: GPIO82 outputs 0 when in output mode.<br>1: GPIO82 outputs 1 when in output mode. |
| 1 | GPIO81_VAL | R/W | LRESET# | 1 | 0: GPIO81 outputs 0 when in output mode.<br>1: GPIO81 outputs 1 when in output mode. |
| 0 | GPIO80_VAL | R/W | LRESET# | 1 | 0: GPIO80 outputs 0 when in output mode.<br>1: GPIO80 outputs 1 when in output mode. |

### 5.1.1.4 Sample Code in C Language

#### 5.1.1.4.1 Control of GP74 to GP77 (DI1 ~ DI4)

```
#define AddrPort 0x4E
```

```
#define DataPort 0x4F
```

<Enter the Extended Function Mode>

```
WriteByte(AddrPort, 0x87)
```

```
WriteByte(AddrPort, 0x87) // Must write twice to enter Extended mode
```

<Select Logic Device>

```
WriteByte(AddrPort, 0x07)
```

```
WriteByte(dataPort, 0x06) // Select logic device 06h
```

<Output/Input Mode Selection> // Set GP74 to GP77 input Mode

```
WriteByte(AddrPort, 0x80) // Select configuration register 80h
```

```
WriteByte(DataPort, 0x0X) // Set (bit 4~7) = 0 to select GP 74~77 as Input mode.
```

<Input Value>

```
WriteByte(AddrPort, 0x82) // Select configuration register 82h
ReadByte(DataPort, Value) // Read bit 4~7 (0xFx)= GP74 ~77 as High.
```

<Leave the Extended Function Mode>

```
WriteByte(AddrPort, 0xAA)
```

#### 5.1.1.4.2 Control of GP80 to GP83 (DO1 ~ DO4)

```
#define AddrPort 0x4E
```

```
#define DataPort 0x4F
```

<Enter the Extended Function Mode>

```
WriteByte(AddrPort, 0x87)
WriteByte(AddrPort, 0x87) // Must write twice to enter Extended mode
```

<Select Logic Device>

```
WriteByte(AddrPort, 0x07)
WriteByte(DataPort, 0x06) // Select logic device 06h
```

<Output/Input Mode Selection>

```
WriteByte(AddrPort, 0x88) // Set GP80 to GP83 output Mode
WriteByte(DataPort, 0xFF) // Select configuration register 88h
WriteByte(DataPort, 0xFF) // Set (bit 0~3) = 1 to select GP 80 ~83 as Output mode.
```

<Output Value>

```
WriteByte(AddrPort, 0x89) // Set GP80 to GP83 output Mode
WriteByte(DataPort, Value) // Select configuration register 89h
WriteByte(DataPort, Value) // Set bit 0~3=(0/1) to output GP 80~83 as Low or High
```

<Leave the Extended Function Mode>

```
WriteByte(AddrPort, 0xAA)
```

#### 5.1.1.5 Change base address

<Enter the Extended Function Mode>

```
WriteByte(AddrPort, 0x87)
WriteByte(AddrPort, 0x87) // Must write twice to enter Extended mode
```

<Select Logic Device>

```
WriteByte(AddrPort, 0x07)
WriteByte(dataPort, 0x06) // Select logic device 06h
```

```
WriteByte(AddrPort, 0x60) // Select configuration register 60h (High Byte address)
```

```
WriteByte(DataPort, (0x0A))
```

```
WriteByte(AddrPort, 0x61) // Select configuration register 61h (Low Byte address)
```

WriteByte(DataPort, (0x00))

<Leave the Extended Function Mode>

WriteByte(AddrPort, 0xAA)

Cincoze default GPIO Port base address is 0xA00h

### 5.1.1.6 DATA Bit Table (DIO)

|   |   |   |   |   |   |   |   |       |
|---|---|---|---|---|---|---|---|-------|
| 7 | 6 | 5 | 4 | 3 | 2 | 1 | 0 | bit   |
| 0 | 0 | 0 | 1 | - | - | - | - | value |
| 1 |   |   |   | X |   |   |   | /h    |

= DI1

(Base  
address +3)  
(0xA03)

|   |   |   |   |   |   |   |   |       |
|---|---|---|---|---|---|---|---|-------|
| 7 | 6 | 5 | 4 | 3 | 2 | 1 | 0 | bit   |
| - | - | - | - | 0 | 0 | 0 | 1 | value |
| X |   |   |   | 1 |   |   |   | /h    |

= DO1

(Base  
address +2)  
(0xA02)

|   |   |   |   |   |   |   |   |       |
|---|---|---|---|---|---|---|---|-------|
| 7 | 6 | 5 | 4 | 3 | 2 | 1 | 0 | bit   |
| 0 | 0 | 1 | 0 | - | - | - | - | value |
| 2 |   |   |   | X |   |   |   | /h    |

= DI2

(Base  
address +3)  
(0xA03)

|   |   |   |   |   |   |   |   |       |
|---|---|---|---|---|---|---|---|-------|
| 7 | 6 | 5 | 4 | 3 | 2 | 1 | 0 | bit   |
| - | - | - | - | 0 | 0 | 1 | 0 | value |
| X |   |   |   | 2 |   |   |   | /h    |

= DO2

Base address  
+2) (0xA02)

|   |   |   |   |   |   |   |   |       |
|---|---|---|---|---|---|---|---|-------|
| 7 | 6 | 5 | 4 | 3 | 2 | 1 | 0 | bit   |
| 0 | 1 | 0 | 0 | - | - | - | - | value |
| 4 |   |   |   | X |   |   |   | /h    |

= DI3

(Base  
address +3)  
(0xA03)

|   |   |   |   |   |   |   |   |       |
|---|---|---|---|---|---|---|---|-------|
| 7 | 6 | 5 | 4 | 3 | 2 | 1 | 0 | bit   |
| - | - | - | - | 0 | 1 | 0 | 0 | value |
| X |   |   |   | 4 |   |   |   | /h    |

= DO3

Base address  
+2) (0xA02)

|   |   |   |   |   |   |   |   |       |
|---|---|---|---|---|---|---|---|-------|
| 7 | 6 | 5 | 4 | 3 | 2 | 1 | 0 | bit   |
| 1 | 0 | 0 | 0 | - | - | - | - | value |
| 8 |   |   |   | X |   |   |   | /h    |

= DI4

(Base  
address +3)  
(0xA03)

|   |   |   |   |   |   |   |   |       |
|---|---|---|---|---|---|---|---|-------|
| 7 | 6 | 5 | 4 | 3 | 2 | 1 | 0 | bit   |
| - | - | - | - | 1 | 0 | 0 | 0 | value |
| X |   |   |   | 8 |   |   |   | /h    |

= DO4

Base address  
+2) (0xA02)

### 5.1.1.7 DIO I/O Port Address (Default Address 0xA00)

| DI4   | DI3 | DI2 | DI1 | DO4   | DO3 | DO2 | DO1 | Pin Definition   |
|-------|-----|-----|-----|-------|-----|-----|-----|------------------|
| 7     | 6   | 5   | 4   | 3     | 2   | 1   | 0   | Data Bits        |
| DI    |     |     |     | DO    |     |     |     | DIO              |
| 0xA03 |     |     |     | 0xA02 |     |     |     | I/O Port address |

## 5.2 DIO Hardware Specification

- XCOM+: Isolated power in V+
- XCOM-: Isolated power in V-
- Isolated power in DC voltage: 9-30V
- 8x Digital Input (Source Type)
- Input Signal Voltage Level
  - Signal Logic 0: XCOM+ = 9V,  $\text{Signal Low} - V_- < 1V$   
XCOM+ > 9V,  $V_+ - \text{Signal Low} > 8V$
  - Signal Logic 1:  $> \text{XCOM+} - 3V$
- Input Driving Sink Current:
  - Minimal: 1 mA
  - Normal: 5 mA
- 8x Digital Output (Open Drain)
  - DO Signal have to pull up resistor to XCOM+ for external device, the resistance will affect the pull up current
  - Signal High Level: Pull up resistor to XCOM+
  - Signal Low Level: = XCOM-
  - Sink Current: 1A (Max)

## 5.2.1 CMI-CD, CMI-ICD Connector Definition



### DIO1: Digital Input / Output Connector

Connector Type: Terminal Block 2X5 10-pin, 3.5mm pitch

| Pin | Definition | Pin | Definition |
|-----|------------|-----|------------|
| 1   | DI1        | 2   | DO1        |
| 3   | DI2        | 4   | DO2        |
| 5   | DI3        | 6   | DO3        |
| 7   | DI4        | 8   | DO4        |
| 9   | DC INPUT   | 10  | GND        |

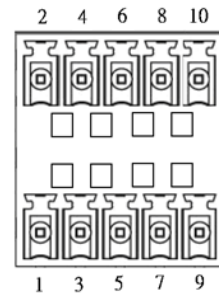

### Reference Input Circuit

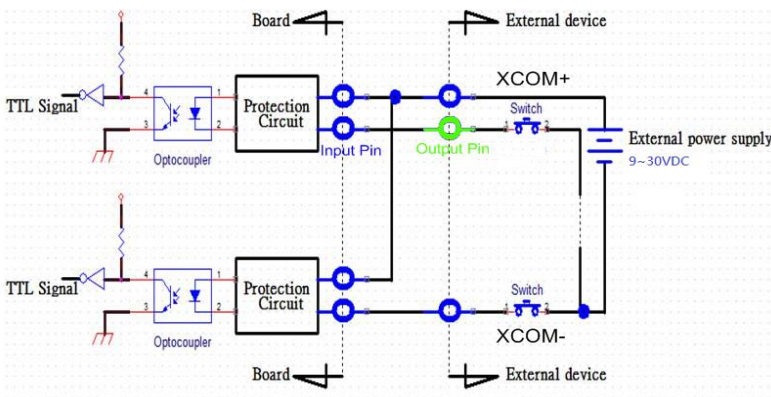

Digital Input Wiring

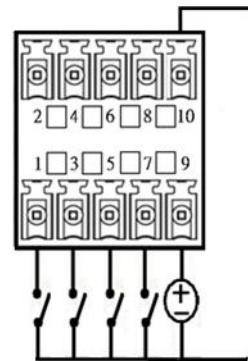

### Reference Output Circuit

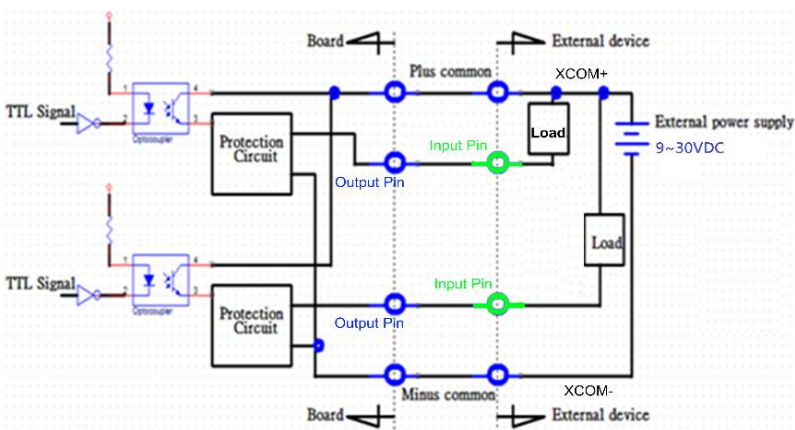

Digital Output Wiring

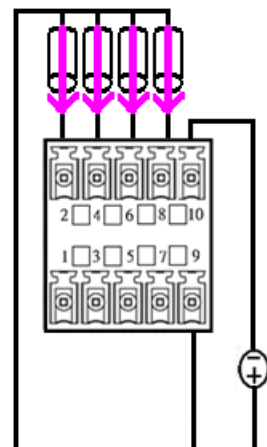

***cincoze***

© 2020 Cincoze Co., Ltd. All rights reserved.

The Cincoze logo is a registered trademark of Cincoze Co., Ltd.

All other logos appearing in this catalog are the intellectual property of the respective company, product, or organization associated with the logo.

All product specifications and information are subject to change without notice.