

chcoze

DS-1200 Series

User Manual



Rugged Embedded Computer

9/8th Generation Intel® Core™ Series Processors

High Performance, Expandable and Modular Rugged Embedded Computer

Content

Preface	5
Revision	5
Copyright Notice	5
Acknowledgement	5
Disclaimer.....	5
Declaration of Conformity.....	6
Product Warranty Statement	6
Technical Support and Assistance	8
Conventions Used in this Manual	8
Safety Precautions.....	8
Package Contents	10
Ordering Information	10
Chapter 1 Product Introductions	11
1.1 Overview	12
1.2 Highlights.....	12
1.3 Product pictures	13
1.4 Key Features	13
1.5 Hardware Specification	14
1.6 System I/O	15
1.7 Mechanical Dimension.....	19
Chapter 2 Switches & Connectors.....	21
2.1 Location of Switches and Connectors	22
2.1.1 Top View.....	22
2.1.2 Bottom View	23
2.2 Switches and Connectors Definition	24
2.3 Definition of Switches	25
2.4 Definition of Connectors	26
Chapter 3 System Setup	33
3.1 Removing Top Cover.....	34
3.2 Installing CPU	37
3.3 Installing SO-DIMM Memory	40
3.4 Installing Mini-PCIe/mSATA Card on Top Side	43
3.5 Installing Mini-PCIe/mSATA Card on Bottom Side.....	45
3.6 Installing Antenna(s)	46
3.7 Installing SATA Hard Drive on Top Side.....	49
3.8 Installing M.2 Card	51
3.9 Installing PCI/PCIe Add-on Card	53
3.10 Installing Top Cover	58
3.11 Removing Maintenance Cover	61
3.12 Installing SATA Hard Drive at Front Side.....	61

3.13 Installing SIM Card	64
3.14 Installing CMOS Battery	65
3.15 Installing Maintenance Cover	67
3.16 Installing Wall Mount Brackets	68
Chapter 4 BIOS Setup	70
4.1 BIOS Introduction	71
4.2 Main Setup	72
4.3 Advanced Setup	73
4.3.1 CPU Configuration	73
4.3.2 SATA Configuration	74
4.3.3 PCH-FW Configuration	74
4.3.4 Trusted Computing	75
4.3.5 ACPI Settings	76
4.3.6 F81866 Super IO Configuration	77
4.3.7 Hardware Monitor	78
4.3.8 S5 RTC Wake Settings	79
4.3.9 Serial Port Console Redirection	79
4.3.10 USB Configuration	80
4.3.11 Network Stack Configuration	81
4.3.12 CSM Configuration	81
4.3.13 NVMe Configuration	82
4.4 Chipset Setup	83
4.4.1 System Agent (SA) Configuration	83
4.4.2 PCH-IO Configuration	84
4.5 Security Setup	87
4.5.1 Administrator Password	87
4.5.2 User Password	87
4.6 Boot Setup	88
4.7 Save & Exit	89
Chapter 5 Product Application	90
5.1 Digital I/O (DIO) application	91
5.1.1 Digital I/O Programming Guide	91
5.2 DIO Hardware Specification	103
5.2.1 DIO Connector Definition	104
Chapter 6 Optional Modules	106
6.1 CMI-COM Connector Definition and Settings	107
6.2 CMI-M12 Connector Definition and Settings	109
6.3 CFM-IGN Connector Definition and Settings	110
6.4 Installing Low Speed CMI Modules	111
6.5 Installing High Speed CMI Modules	114
6.5.1 CMI-M12LAN01-R10/UB1010 Module	114
6.5.2 CMI-XM12LAN01-R10/UB1030 Module	117

6.6 Installing CFM-PoE Module	120
6.7 Installing CFM-IGN Module.....	124
6.8 Installing External FAN	125
6.9 Installing Internal FAN (For DS-1202 only)	127

Preface

Revision

Revision	Description	Date
1.00	First Release	2018/10/23
1.10	Correction Made	2018/11/20
1.20	Update the Supporting Capacity of Memory to the latest	2019/11/08
1.30	Correction Made	2019/12/18
1.40	Add the latest supported processors	2019/12/31
1.50	Add CMI-XM12LAN01-R10 installation steps	2021/07/26
1.51	Correction Made	2021/08/10
1.52	Correction Made	2021/08/31
1.53	Correction Made	2022/05/31
1.54	Correction Made	2023/04/14
1.55	Correction Made	2023/09/21

Copyright Notice

© 2018 by Cincoze Co., Ltd. All rights are reserved. No parts of this manual may be copied, modified, or reproduced in any form or by any means for commercial use without the prior written permission of Cincoze Co., Ltd. All information and specification provided in this manual are for reference only and remain subject to change without prior notice.

Acknowledgement

Cincoze is a registered trademark of Cincoze Co., Ltd. All registered trademarks and product names mentioned herein are used for identification purposes only and may be trademarks and/or registered trademarks of their respective owners.

Disclaimer

This manual is intended to be used as a practical and informative guide only and is subject to change without notice. It does not represent a commitment on the part of Cincoze. This product might include unintentional technical or typographical errors. Changes are periodically made to the information herein to correct such errors, and these changes are incorporated into new editions of the publication.

Declaration of Conformity



FCC

This equipment has been tested and found to comply with the limits for a Class A digital device, pursuant to Part 15 of the FCC Rules. These limits are designed to provide reasonable protection against harmful interference when the equipment is operated in a commercial environment. This equipment generates, uses, and can radiate radio frequency energy and, if not installed and used in accordance with the instruction manual, may cause harmful interference to radio communications. Operation of this equipment in a residential area is likely to cause harmful interference in which case the user will be required to correct the interference at his own expense.



CE

The product(s) described in this manual complies with all application European Union (CE) directives if it has a CE marking. For computer systems to remain CE compliant, only CE-compliant parts may be used. Maintaining CE compliance also requires proper cable and cabling techniques.



E-Mark

The "E" mark is based on ECE regulations issued by the Economic Commission for Europe. It is an organizational part of the UN and the members are EU countries and many others. Therefore, the acceptance of approved components is much broader, especially in the eastern part of Europe. It is necessary to confirm whether a particular country has accepted (signed) the application of an ECE-regulation; as the application it is not mandatory for the countries.

Product Warranty Statement

Warranty

Cincoze products are warranted by Cincoze Co., Ltd. to be free from defect in materials and workmanship for 2 years from the date of purchase by the original purchaser. During the warranty period, we shall, at our option, either repair or replace any product that proves to be defective under normal operation. Defects, malfunctions, or failures of the warranted product caused by damage resulting from natural disasters (such as by lightning, flood, earthquake, etc.), environmental and atmospheric disturbances, other external forces such as power line disturbances, plugging the board in under power, or incorrect cabling, and damage caused by misuse, abuse, and unauthorized alteration or repair, and the product in question is either software, or an expendable item (such as a fuse, battery, etc.), are not warranted.

RMA

Before sending your product in, you will need to fill in Cincoze RMA Request Form and obtain a RMA number from us. Our staff is available at any time to provide you with the most friendly and immediate service.

■ RMA Instruction

- Customers must fill in Cincoze Return Merchandise Authorization (RMA) Request Form and obtain an RMA number prior to returning a defective product to Cincoze for service.
- Customers must collect all the information about the problems encountered and note anything abnormal and describe the problems on the "Cincoze Service Form" for the RMA number apply process.
- Charges may be incurred for certain repairs. Cincoze will charge for repairs to products whose warranty period has expired. Cincoze will also charge for repairs to products if the damage resulted from acts of God, environmental or atmospheric disturbances, or other external forces through misuse, abuse, or unauthorized alteration or repair. If charges will be incurred for a repair, Cincoze lists all charges, and will wait for customer's approval before performing the repair.
- Customers agree to ensure the product or assume the risk of loss or damage during transit, to prepay shipping charges, and to use the original shipping container or equivalent.
- Customers can be sent back the faulty products with or without accessories (manuals, cable, etc.) and any components from the system. If the components were suspected as part of the problems, please note clearly which components are included. Otherwise, Cincoze is not responsible for the devices/parts.
- Repaired items will be shipped along with a "Repair Report" detailing the findings and actions taken.

Limitation of Liability

Cincoze' liability arising out of the manufacture, sale, or supplying of the product and its use, whether based on warranty, contract, negligence, product liability, or otherwise, shall not exceed the original selling price of the product. The remedies provided herein are the customer's sole and exclusive remedies. In no event shall Cincoze be liable for direct, indirect, special or consequential damages whether based on contract of any other legal theory.

Technical Support and Assistance

1. Visit the Cincoze website at www.cincoze.com where you can find the latest information about the product.
2. Contact your distributor or our technical support team or sales representative for technical support if you need additional assistance. Please have following information ready before you call:
 - Product name and serial number
 - Description of your peripheral attachments
 - Description of your software (operating system, version, application software, etc.)
 - A complete description of the problem
 - The exact wording of any error messages

Conventions Used in this Manual



WARNING

This indication alerts operators to an operation that, if not strictly observed, may result in severe injury.



CAUTION

This indication alerts operators to an operation that, if not strictly observed, may result in safety hazards to personnel or damage to equipment.



NOTE

This indication provides additional information to complete a task easily.

Safety Precautions

Before installing and using this device, please note the following precautions.

1. Read these safety instructions carefully.
2. Keep this User's Manual for future reference.
3. Disconnect this equipment from any AC outlet before cleaning.
4. For plug-in equipment, the power outlet socket must be located near the equipment and must be easily accessible.
5. Keep this equipment away from humidity.
6. Put this equipment on a reliable surface during installation. Dropping it or letting it fall may cause damage.
7. Make sure the voltage of the power source is correct before connecting the equipment to the power outlet.

8. Use a power cord that has been approved for using with the product and that it matches the voltage and current marked on the product's electrical range label. The voltage and current rating of the cord must be greater than the voltage and current rating marked on the product.
9. Position the power cord so that people cannot step on it. Do not place anything over the power cord.
10. All cautions and warnings on the equipment should be noted.
11. If the equipment is not used for a long time, disconnect it from the power source to avoid damage by transient overvoltage.
12. Never pour any liquid into an opening. This may cause fire or electrical shock.

13. Never open the equipment. For safety reasons, the equipment should be opened only by qualified service personnel.
If one of the following situations arises, get the equipment checked by service personnel:
 - The power cord or plug is damaged.
 - Liquid has penetrated into the equipment.
 - The equipment has been exposed to moisture.
 - The equipment does not work well, or you cannot get it work according to the user's manual.
 - The equipment has been dropped and damaged.
 - The equipment has obvious signs of breakage.
14. CAUTION: Danger of explosion if battery is incorrectly replaced. Replace only with the same or equivalent type recommended by the manufacturer.
15. Equipment intended only for use in a RESTRICTED ACCESS AREA.

Package Contents

Before installation, please ensure all the items listed in the following table are included in the package.

Item	Description	Q'ty
1	Embedded System	1
2	Heat Sink Pack	1
3	Screw Pack	1
4	Wall Mounting Kit	1
5	Power Terminal Block Connector	1
6	Remote Power On/Off Terminal Block Connector	1
7	Remote Power Reset Terminal Block Connector	1
8	Fan Terminal Block Connector	1
9	DVI-I to VGA Adaptor	1

Note: *Notify your sales representative if any of the above items are missing or damaged.*

Ordering Information

Model No.	Product Description
DS-1200-R10	9/8th Generation Intel® Core™ Series Processors, High Performance, Expandable and Modular Rugged Embedded Computer
DS-1201-R10	9/8th Generation Intel® Core™ Series Processors, High Performance, Expandable and Modular Rugged Embedded Computer with 1x PCI/PCIe Expansion Slots
DS-1202-R10	9/8th Generation Intel® Core™ Series Processors, High Performance, Expandable and Modular Rugged Embedded Computer with 2x PCI/PCIe Expansion Slots



Chapter 1

Product Introductions

1.1 Overview

DS-1200 series is a high performance fanless embedded computer, powered by 9/8th generation Intel® Core™ processor (Coffee Lake) with up to 8 cores and 64GB DDR4 memory capacity for unprecedented performance to fulfill all kinds of high-end computing requirements. The system also incorporates rich I/O, such as 2x Intel® GbE ports, 2x USB 3.1 (Gen2), 4x USB 3.0, 1x DVI-I, 2x DisplayPort, and 1x M.2 Key M 2280 socket for ultra-fast data transfer speed.

Based on Cincoze' innovative CMI & CFM Technology, it allows users to expand I/O and functionalities through ready-to-use modules, such as GbE/PoE ports, serial ports, optical isolated digital I/O and power ignition function. Furthermore, DS-1200 series supports maximum 2 PCI(e) expansion slots to accommodate versatile add-on cards.

Designed to operate under harsh conditions, DS-1200 series has passed rigorous testing like EN50155 (EN50121-3-2) and EN62368-1 to fulfill industrial applications such as rolling stock. Besides, DS-1200 series features with wide operating temperature (-40°C to 70°C), wide range DC power input (from 9V to 48V), high tolerance of shock/vibration (5G/50G), and industrial-grade protections (OVP, OCP, ESD Surge, ...etc).

1.2 Highlights

High Performance

The new 9/8th generation Intel® Core™ processor (Coffee Lake) offers for the first time up to 8 cores, 16 threads and 1.4 times computing performance improvement comparing to the previous generation (Kaby Lake).



Fully Modular and Expandable

Featuring PCI/PCIe expansion slots, Mini-PCIe slots, CMI (Combined Multiple I/O), CFM (Control Function Module), and versatile ready-to-use modules, DS-1200 series provides great flexibility to configure the system according to your need.

Wide Temperature

DS-1200 series is designed for continuous operation in wide temperature range from -40°C to 70°C. In addition, it also features with anti-shock/vibration and ESD/surge protection for tough industrial environments.



1.3 Product pictures

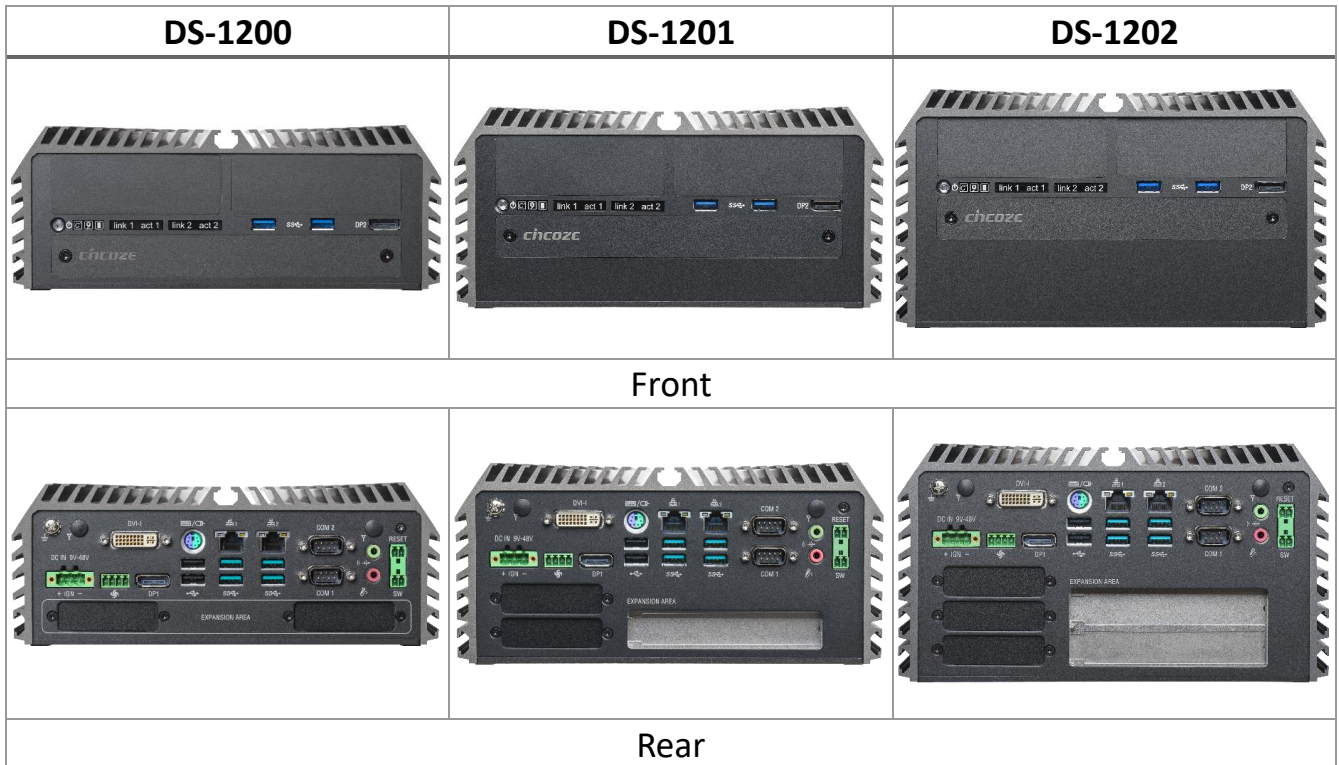

1.4 Key Features

- Supports 9/8th Gen Intel® Core™ / Pentium® / Celeron® Octa Cores 35W/65W LGA 1151 Processors
- 2x DDR4 SO-DIMM Socket, Supports Up to 2666MHz, 64GB
- Triple Independent Displays: 1x DVI-I and 2x DP (4K Resolution)
- 1x M.2 2280 M Key Socket, Auto-detection for PCIe4 NVMe SSD or SATA Gen3 SSD
- 2x Front Accessible SIM Card Slots for Signal Redundancy
- 2x PCI/PCIe Slots for Add-on Cards (Maximum Length: 235mm) (For DS-1201 & DS-1202 only)
- 4x CMI Slots for Modular I/O Expansions
- 1x CFM Slot for Power Ignition Sensing Function
- Wide Operating Temperature (-40°C to 70°C)
- EN50155 (EN50121-3-2) / EN62368-1 Certified

1.5 Hardware Specification

Processor

- 9th Generation Intel® Coffee Lake-R S Series CPU:
 - Intel® Core™ i7-9700E 8 Cores Up to 4.4 GHz, TDP 65W
 - Intel® Core™ i5-9500E 6 Cores Up to 4.2 GHz, TDP 65W
 - Intel® Core™ i3-9100E 4 Cores Up to 3.7 GHz, TDP 65W
 - Intel® Core™ i7-9700TE 8 Cores Up to 3.8 GHz, TDP 35W
 - Intel® Core™ i5-9500TE 6 Cores Up to 3.6 GHz, TDP 35W
 - Intel® Core™ i3-9100TE 4 Cores Up to 3.2 GHz, TDP 35W
- 8th Generation Intel® Coffee Lake S Series CPU:
 - Intel® Core™ i7-8700 6 Cores Up to 4.6 GHz - 12M Cache, TDP 65W
 - Intel® Core™ i5-8500 6 Cores Up to 4.1 GHz - 9M Cache, TDP 65W
 - Intel® Core™ i3-8100 4 Cores 3.6 GHz - 6M Cache, TDP 65W
 - Intel® Core™ i7-8700T 6 Cores Up to 4.0 GHz - 12M Cache, TDP 35W
 - Intel® Core™ i5-8500T 6 Cores Up to 3.5 GHz - 9M Cache, TDP 35W
 - Intel® Core™ i3-8100T 4 Cores 3.1 GHz - 6M Cache, TDP 35W
 - Intel® Pentium® G5400 2 Cores 3.7 GHz - 4M Cache, TDP 58W
 - Intel® Pentium® G5400T 2 Cores 3.1 GHz - 4M Cache, TDP 35W
 - Intel® Celeron® G4900 2 Cores 3.1 GHz - 2M Cache, TDP 54W
 - Intel® Celeron® G4900T 2 Cores 2.9 GHz - 2M Cache, TDP 35W

Chipset

- Intel® Q370

BIOS

- AMI 32MB SPI BIOS

Memory

- 2x DDR4-2400/2666 MHz SO-DIMM Sockets, Supports up to 64 GB (Un-buffered and Non-ECC Type)
 - * DDR4 2666MHz memory modules are only for Core™ i7/i5 Processors

Graphics

- Integrated Intel® UHD Graphics 630: Core™ i7/i5/i3
- Integrated Intel® UHD Graphics 610: Pentium® /Celeron®
- Supports Triple Independent Display (1x DVI-I, 2x DisplayPort)

Audio

- Realtek® ALC888
- High Definition Audio

External I/O Interface

- 1x DVI-I (DVI-D: 1920 x 1200 @60Hz / VGA: 1920 x 1080 @60Hz)
- 2x DisplayPort (DisplayPort: 4096 x 2304 @60Hz)
- 2x GbE LAN (Supports WoL, Teaming, Jumbo Frame & PXE), RJ45
 - GbE1: Intel® I210
 - GbE2: Intel® I219-LM
- 2x USB 3.1 Gen2 (Type A)
- 4x USB 3.0 (Type A)
- 2x USB 2.0 (Type A)
- 2x RS-232/422/485 with Auto Flow Control (Supports 5V/12V), DB9
- 1x PS/2, 6-pin mini-DIN Female Connector
- 1x Line-out & 1x Mic-in, Phone Jack 3.5mm
- 1x ATX Power On/Off Button
- 1x AT/ATX Mode Switch
- 1x Clear CMOS Switch
- 1x Remote Reset Connector, 2-pin Terminal Block
- 1x Remote Power On/Off Connector, 2-pin Terminal Block
- 1x External Fan Connector, 4-Pin Terminal Block (Supports smart fan by BIOS)

Storage

- 2x 2.5" SATA HDD/SSD bay (Gen3), 1x Internal, 1x Front Accessible Supports RAID 0/1
- 3x mSATA (shared by Mini-PCIe socket) (Gen3), BIOS Selectable
- 1x M.2 Key M 2280 Socket, Supports PCIe x4 NVMe SSD or SATA SSD (Gen3)

Expansion

- 3x Full-size Mini-PCIe Socket

- 2x SIM Socket
- 1x CFM (Control Function Module) Interface
- 2x CMI (Combined Multiple I/O) High Speed Interface
- 2x CMI (Combined Multiple I/O) Low Speed Interface
- 2x Antenna Hole
- 1x PCI/PCIe Expansion slot (with Optional Riser Card) (For DS-1201)
 - * Supports maximum dimensions of add-on card (H x L):111 x 235mm
- 2x PCI/PCIe Expansion slot (with Optional Riser Card) (For DS-1202)
 - * Supports maximum dimensions of add-on card (H x L):111 x 235mm

Other Function

- Supports Instant Reboot Technology (0.2 sec)
- SuperCap Integrated for CMOS Battery Maintenance-free Operation
- Watchdog Timer: Software Programmable Supports 256 Levels System Reset

Power Requirement

- Supports AT/ATX Power Type
- Power Input Voltage 9-48VDC
- 1x 3-Pin Terminal Block
- Power Adapter AC/DC 24V/5A 120W or 24V/9.2A 220W (Optional)

Physical

- Dimensions (WxDxH):
 - 227 x 261 x 88 mm (DS-1200), 227 x 261 x 108 mm (DS-1201)
 - 227 x 261 x 128 mm (DS-1202)
- Weight: 4.3 kg (DS-1200), 4.92 kg (DS-1201), 5.14 kg (DS-1202)
- Construction: Extruded Aluminum with Heavy Duty Metal
- Mounting: Wall Mount • Unibody Chassis
- Fanless Design • Jumper-less Design

Protection

- Reverse Power Input Protection
- Over Voltage Protection
 - Protection Range: 51-58V
 - Protection Type: shut down operating voltage, re-power on at the present level to recover
- Over Current Protection: 15A
- ESD Protection: +/-8kV (air), +/-4kV (contact)
- Surge Protection: 2 kV

Operating System

- Windows® 10
- Linux: Supports by project

Environment

- Operating Temperature:
 - 35W TDP Processor: -40°C to 70°C
 - 51~65W TDP Processor: -40°C to 45°C
- * PassMark BurnInTest: 100% CPU, 2D/3D Graphics (without thermal throttling)
- * With extended temperature peripherals; Ambient with air flow
- * According to IEC60068-2-1, IEC60068-2-2, IEC60068-2-14
- Storage Temperature: -40°C to 85°C
- Relative Humidity: 95%RH @ 70°C (non-Condensing)
- Shock: Operating, 50 Grms, Half-sine 11 ms Duration (w/ SSD, according to IEC60068-2-27)
- Vibration: Operating, 5 Grms, 5-500 Hz, 3 Axes (With SSD, according to IEC60068-2-64)
- MTBF: 396,565 Hours

Certification

- EMC: CE, FCC Class A
- Safety: LVD, EN62368-1
- Railway: EN50155, EN50121-3-2

** Product Specifications and features are for reference only and are subject to change without prior notice. For more information, please refer to the latest product datasheet from Cincoze's website.*

1.6 System I/O

1.6.1 Front

ATX Power On/Off

Used to power-on or power-off the system

AT/ATX Mode Select Switch

Used to select AT or ATX power mode

Power LED

Indicates the power status of the system

Temperature LED

Indicates the temperature of the system

HDD LED

Indicates the status of the hard drive

Digital I/O LED

Indicates the working status of digital input/ output

Ethernet LED

Indicates the status of the LAN ports

USB 3.1 Port

Used to connect USB 3.1/3.0/2.0/1.1 device

DisplayPort

Used to connect the system with DisplayPort monitor

SIM card, CMOS Battery, and 2.5" Removable HDD Bay

Used to inserts a SIM card, CMOS battery, and 2.5" HDD

DS-1200

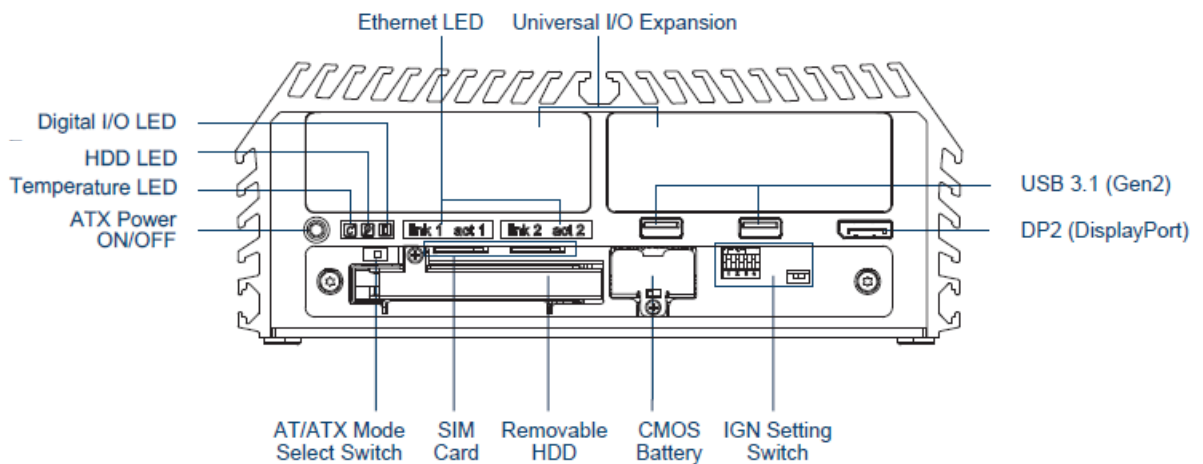

DS-1201

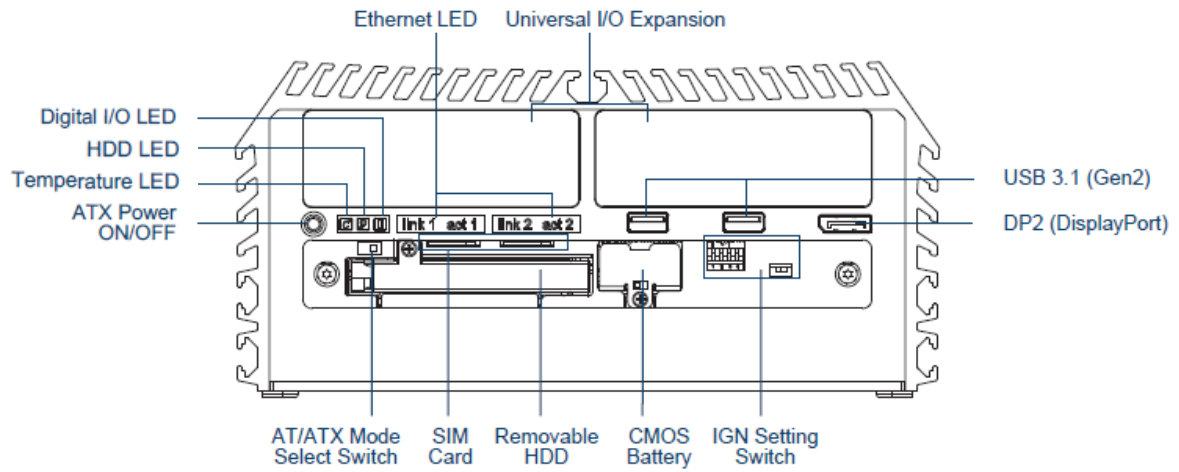

DS-1202

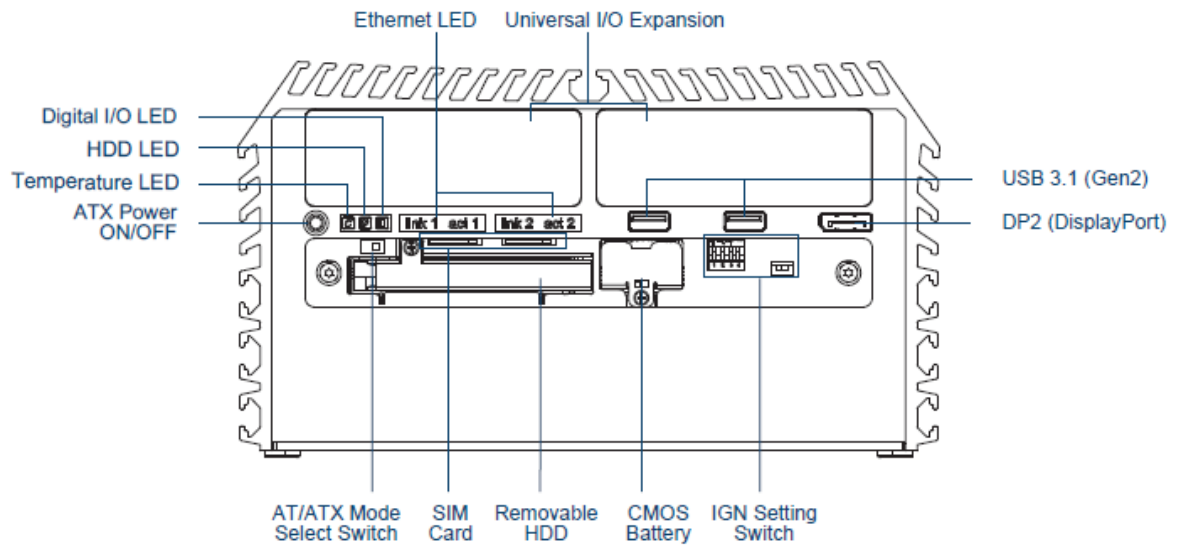

1.6.2 Rear

DC IN Terminal Block

Used to plug a DC power input with terminal block

External Fan Terminal Block

Used to plug an external fan with terminal block

DVI-I Port

Used to connect a DVI monitor or connect optional split cable for dual display mode

PS/2 Port

Used to connect the PS/2 device

LAN Port

Used to connect to local area network

Display Port

Used to connect a monitor with DisplayPort interface

USB 3.0 Port

Used to connect USB 3.0/2.0/1.1 device

USB 2.0 Port

Used to connect USB 2.0/1.1 device

Antenna Hole

Used to connect an antenna for optional wireless module

COM Port

Used to connect to RS-232/422/485 serial devices

Line-Out

Used to connect a speaker

Mic-In

Used to connect a microphone

Remote Power On/Off & Remote Power Reset Terminal Block

Terminal Block

A terminal block used to connect to remote power on/off switch

Universal I/O Bracket

Used to customized I/O output

DS-1200

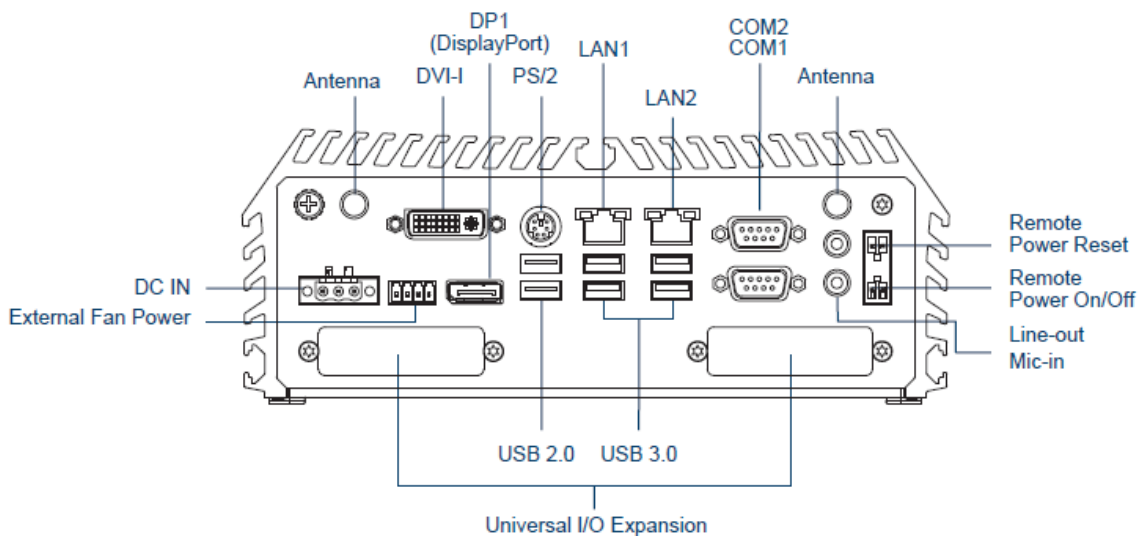

DS-1201

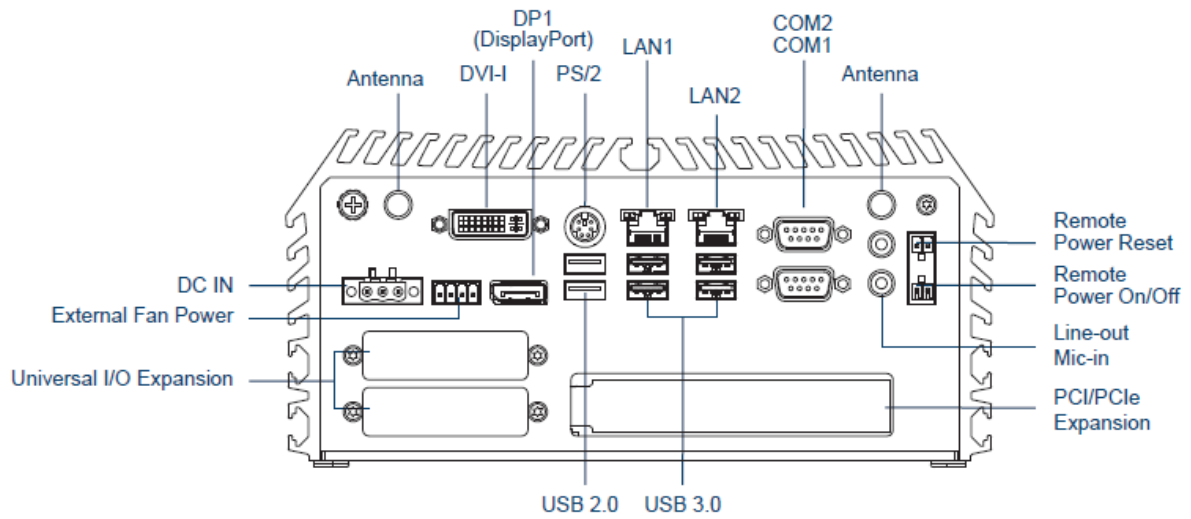

DS-1202

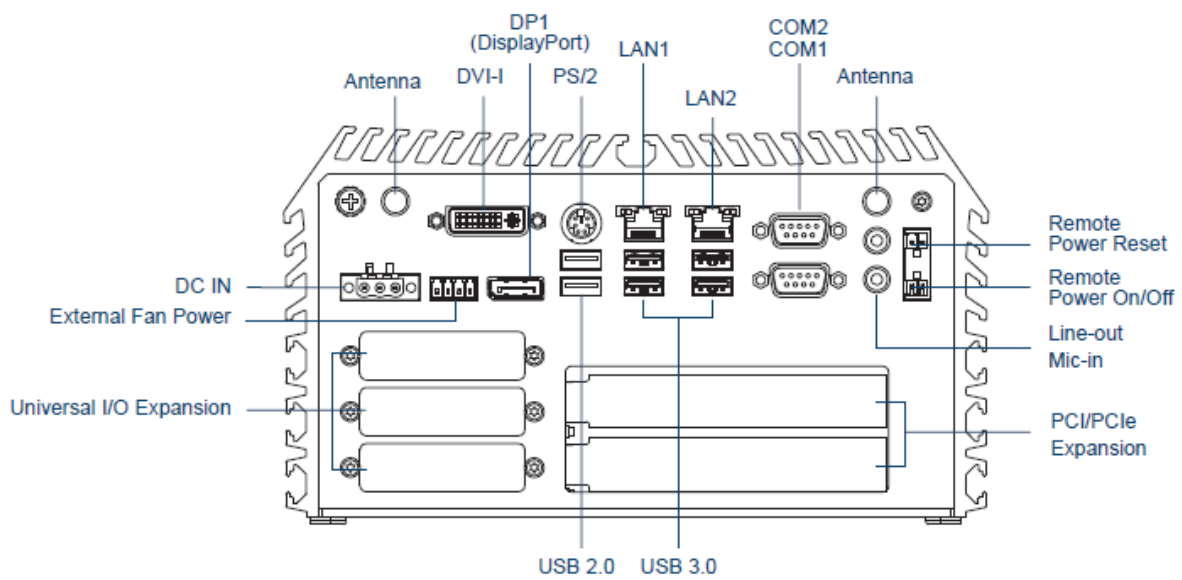

1.7 Mechanical Dimension

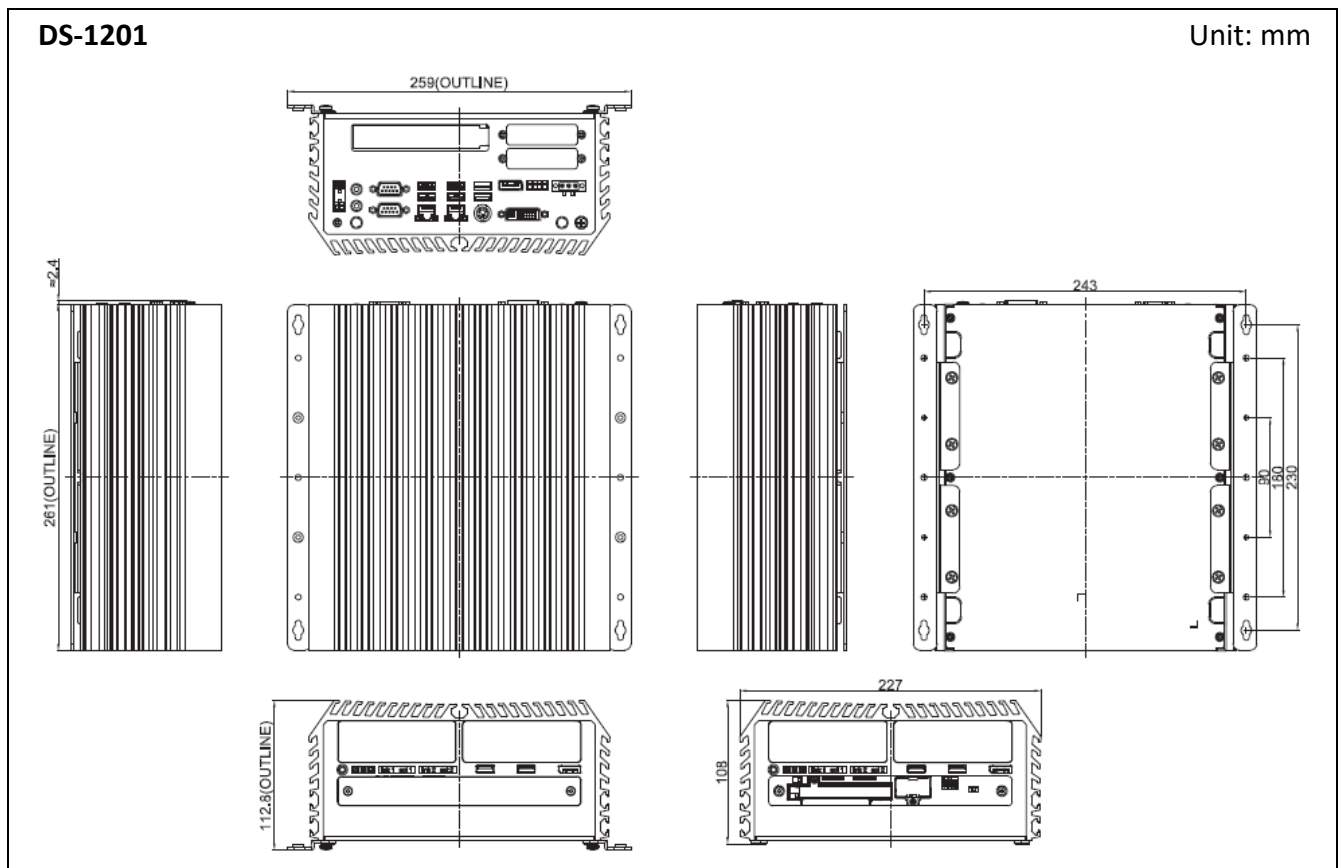
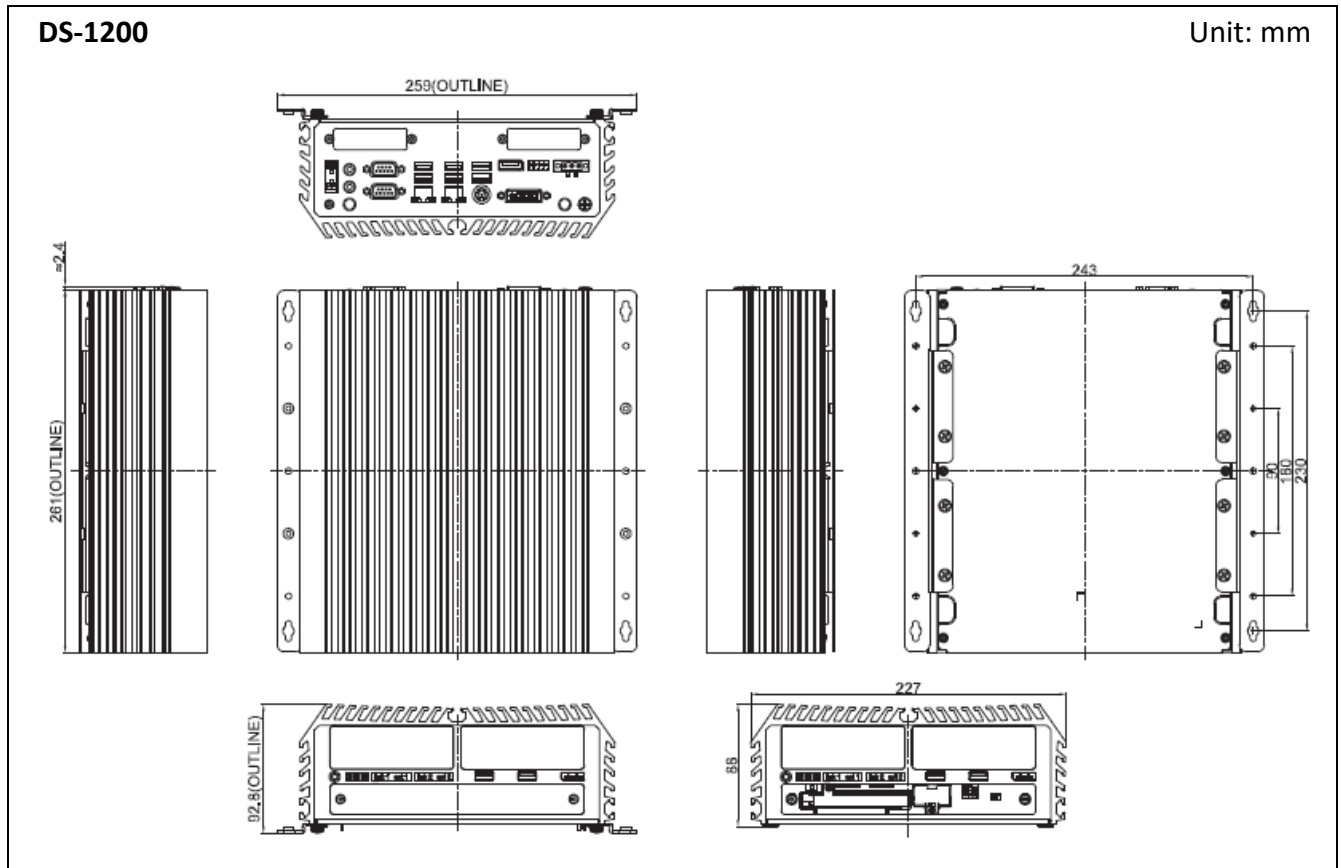

DS-1202

Unit: mm

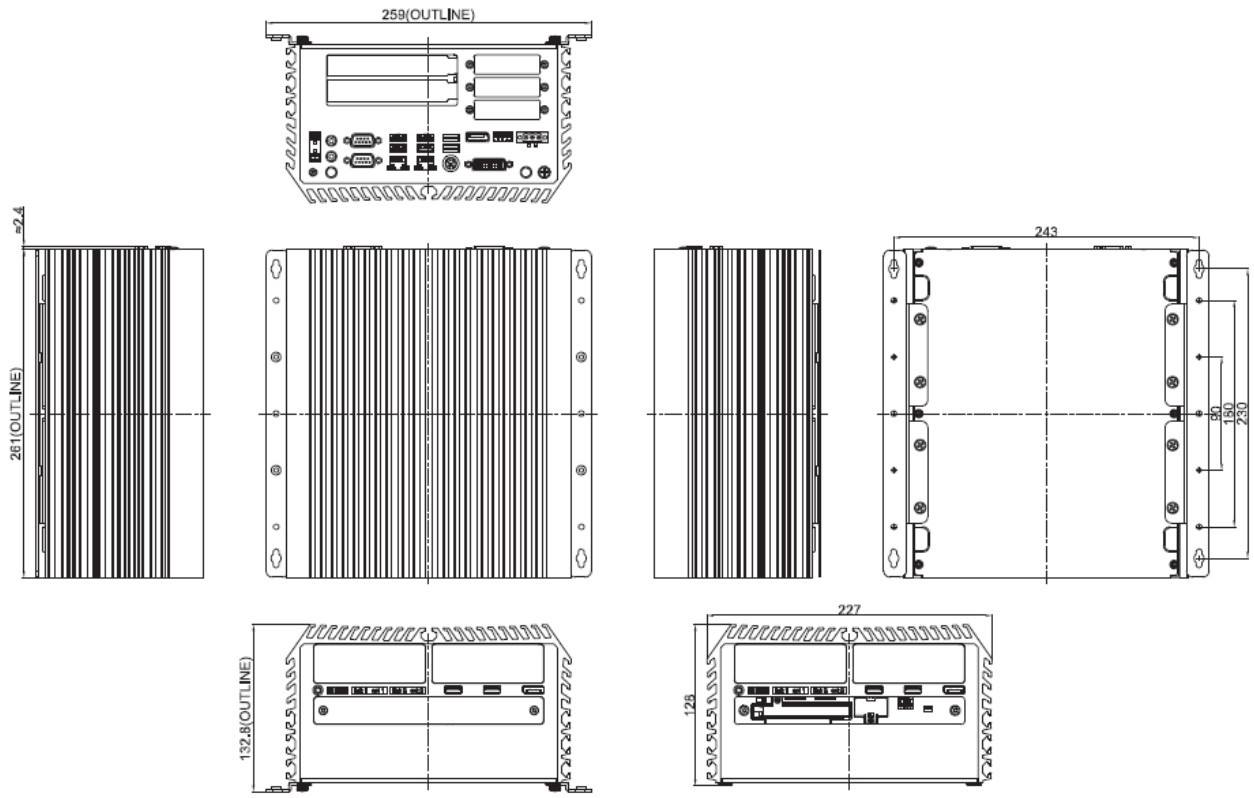



Chapter 2

Switches & Connectors

2.1 Location of Switches and Connectors

2.1.1 Top View

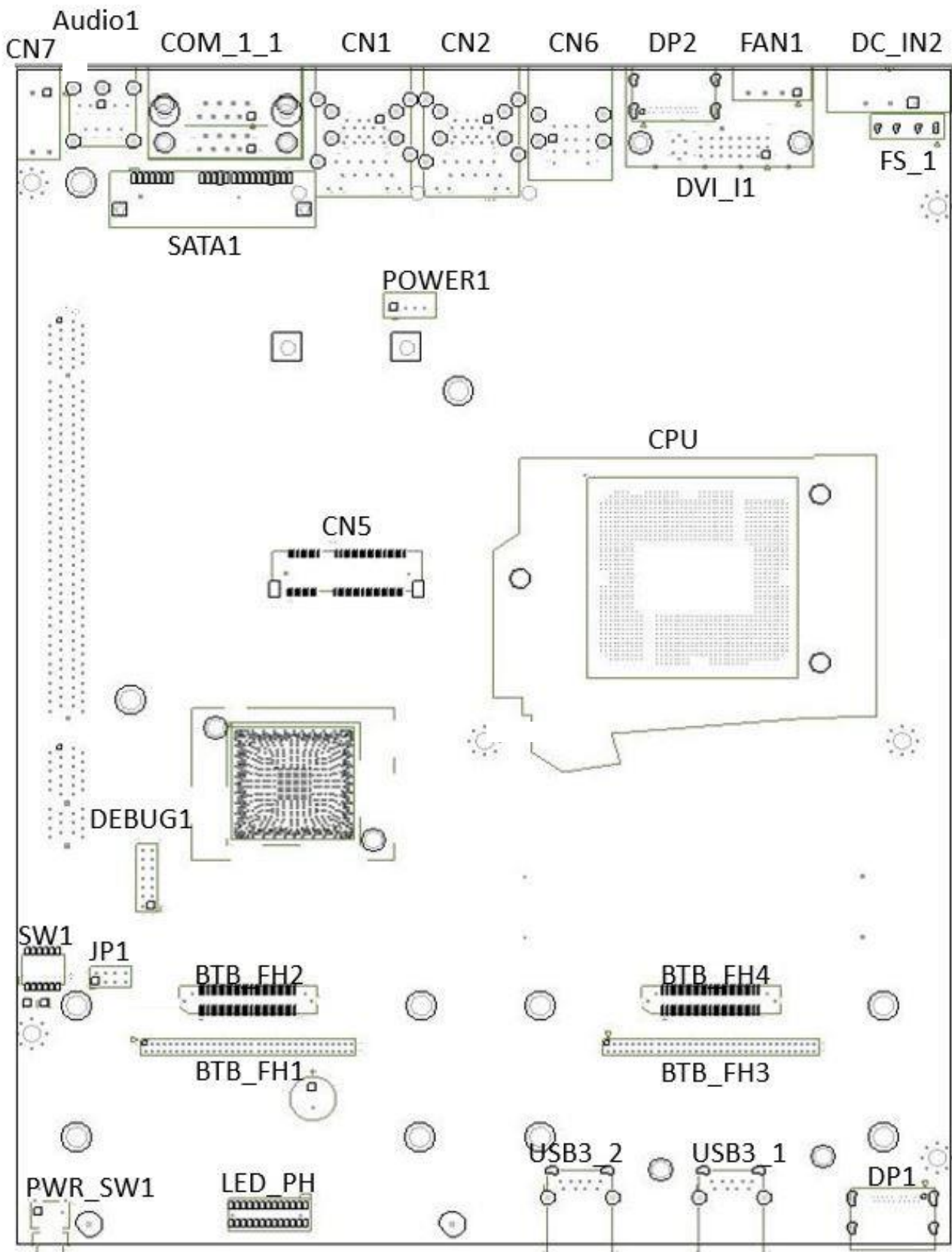

2.1.2 Bottom View

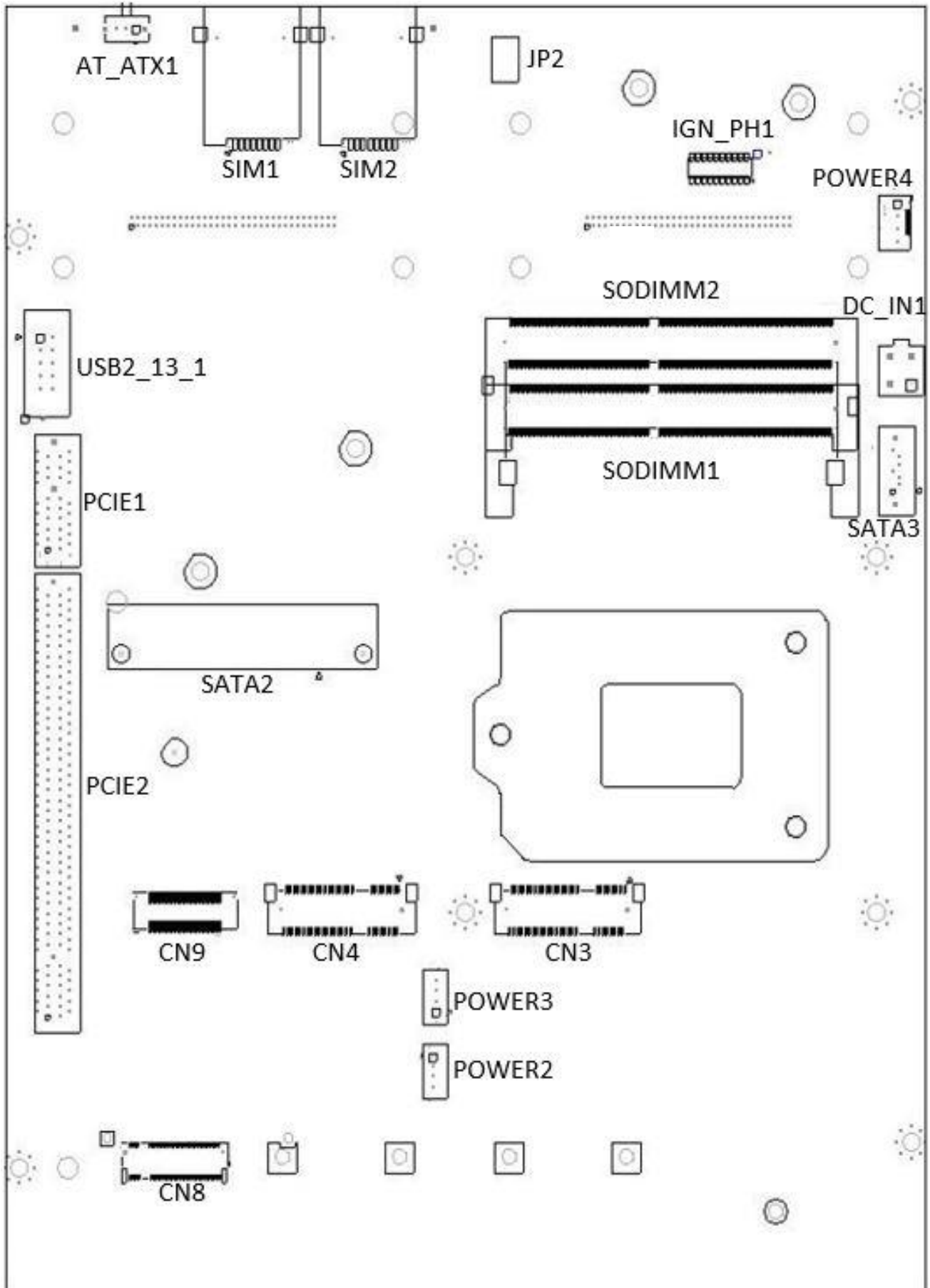

2.2 Switches and Connectors Definition

List of Switch and Connectors

Location	Definition
SW1	RTC / SATA DOM / COM1 / COM2 Power Select
JP1	BIOS SPI interface (Optional)
JP2	RTC Battery board to board connector
AT_ATX1	AT / ATX Power Mode Switch
Debug1	Engineer Use / LPC 80 Port interface (Optional)
PWR_SW1	Power Button, System LED
BTB_FH1, BTB_FH3	DIO + COM Port Board to Board Connector
BTB_FH2, BTB_FH4	PSE LAN Port Board to Board Connector
IGN_PH1	IGN Board to Board connector
FS1	Input Fuse 15A
DC_IN1	4-PIN DC Out
DC_IN2	3-PIN DC 9-48V Power Input with Power Ignition Connector
FAN1	External PWM Fan Connector
DP1, DP2	DisplayPort Connector
DVI_I1	DVI-I Connector
CN6	PS/2 and USB 2.0 Ports
CN1	LAN1 and USB 3.0 Ports
CN2	LAN2 and USB 3.0 Ports
COM_1_1	COM1 / COM2, RS232 / RS422 / RS485 Connector
AUDIO1	Audio Jack / MIC_IN / LINE_OUT
CN7	Remote Power on/off, Remote Reset Switch Connector
USB3_1, USB3_2	USB 3.1 Ports
SIM1, SIM2	SIM Card Socket
SATA1, SATA2	22 Pin SATA Connector
SATA3	SATA Connector
Power 1~4	Power Connector
CN5	Mini PCI-Express Socket + mSATA + 4G Module
CN3, CN4	Mini PCI-Express / mSATA Socket
CN8	M.2 PCIE / SATA SSD
USB2_13_1	Internal USB 2.0 Ports
PCIE1	PCI-Express X1 Socket
PCIE2	PCI-Express X16 Socket
SODIMM1, SODIMM2	DDR4 SODIMM Socket

2.3 Definition of Switches

AT_ATX1: AT / ATX Power Mode Switch

Switch	Definition
1-2 (Right)	ATX Power Mode (Default)
2-3 (Left)	AT Power Mode



SW1: RTC / SATA DOM / COM1 / COM2 Power Select

Super CAP Function Setting: Pin Define SW1 Switch

Switch mode	Function	ON	OFF
1	Super CAP	Enable (Default)	Disable

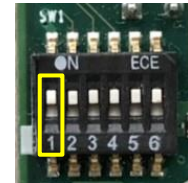

ON
OFF

SATA DOM Function Setting: Pin Define SW1 Switch

Switch mode	Function	ON	OFF
2	SATA DOM	Disable (Default)	Enable

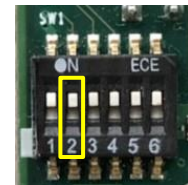

ON
OFF

COM1/2 Voltage Function Setting: Pin Define SW1 Switch

Switch mode	Function	ON	OFF
3-4	COM1	0V(RI)	ON/ON (Default)
		5V	ON/OFF
		12V	OFF/OFF
5-6	COM2	0V(RI)	ON/ON (Default)
		5V	ON/OFF
		12V	OFF/OFF

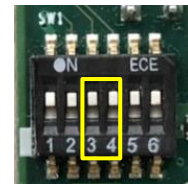

ON
OFF



ON
OFF

2.4 Definition of Connectors

CN5 : Mini PCI-Express Socket (Support mSATA and SIM Card to Link feature)

Pin	Definition	Pin	Definition	Pin	Definition
1	WAKE#	19	SIM_DATA2	37	RESERVED
2	3.3V	20	3.3V	38	USB_D+
3	NA	21	GND	39	RESERVED
4	GND	22	PERST#	40	GND
5	NA	23	PERN/SATARP	41	3.3V
6	1.5V	24	3.3V	42	NA
7	UIM_RST2	25	PERP/SATARN	43	GND
8	SIM_PWR1	26	GND	44	NA
9	GND	27	GND	45	NA
10	SIM_DATA1	28	+1.5V	46	NA
11	REFCLK-	29	GND	47	NA
12	SIM_CLK	30	SMB_CLK	48	+1.5V
13	REFCLK+/SIM_PWR2	31	PETN/SATATN	49	NA
14	SIM_Reset1	32	SMB_DATA	50	GND
15	GND	33	PETP/SATAPN	51	NA
16	SIM_VPP1	34	GND	52	+3.3V
17	SIM_CLK2	35	GND		
18	GND	36	USB_D-		

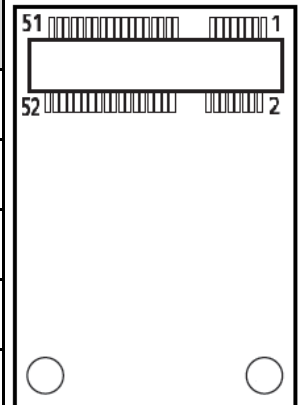

CN4 : Mini PCI-Express Socket (Support mSATA feature)

Pin	Definition	Pin	Definition	Pin	Definition
1	WAKE#	19	NA	37	GND
2	3.3V	20	3.3V	38	USB_D+
3	NA	21	GND	39	3.3V
4	GND	22	PERST#	40	GND
5	NA	23	PERN/SATARXP	41	3.3V
6	1.5V	24	3.3V	42	NA
7	NA	25	PERPSATARXN	43	GND
8	NA	26	GND	44	NA
9	GND	27	GND	45	NA
10	NA	28	+1.5V	46	NA
11	NA	29	GND	47	NA
12	NA	30	SMB_CLK	48	+1.5V
13	NA	31	PETN/SATATXN	49	NA
14	NA	32	SMB_DATA	50	GND
15	GND	33	PETP/SATATXP	51	NA
16	NA	34	GND	52	+3.3V
17	NA	35	GND		
18	GND	36	USB_D-		

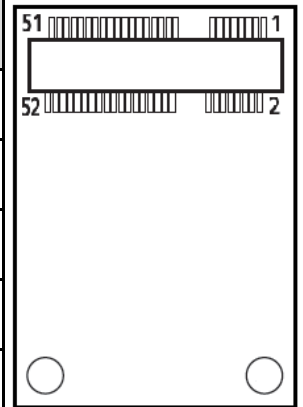

CN3: Mini PCI-Express Socket (Support mSATA feature)

Pin	Definition	Pin	Definition	Pin	Definition
1	WAKE#	19	NA	37	GND
2	3.3V	20	3.3V	38	USB_D+
3	NA	21	GND	39	3.3V
4	GND	22	PERST#	40	GND
5	NA	23	PERN/SATARP	41	3.3V
6	1.5V	24	+3.3VAUX	42	NA
7	CLKREQ#	25	PERP/SATARN	43	GND
8	NA	26	GND	44	NA
9	GND	27	GND	45	NA
10	NA	28	+1.5V	46	NA
11	REFCLK-	29	GND	47	NA
12	NA	30	SMB_CLK	48	+1.5V
13	REFCLK+	31	PETN/SATATN	49	NA
14	NA	32	SMB_DATA	50	GND
15	GND	33	PETP/SATATP	51	NA
16	NA	34	GND	52	+3.3V
17	NA	35	GND		
18	GND	36	USB_D-		

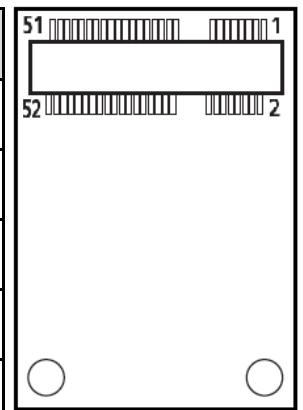

CN8: M.2 Socket Socket (Support M.2 PCIE / SATA SSD feature)

Pin	Definition	Pin	Definition	Pin	Definition
1	CFG3	27	GND	53	REFCLKN
2	+3.3V	28	NC	54	PEWAKE#
3	GND	29	PERN1	55	REFCLKP
4	+3.3V	30	NC	56	NC
5	PERN3	31	PERP1	57	GND
6	NC	32	NC	58	NC
7	PERP3	33	GND	59	key
8	NC	34	NC	60	key
9	GND	35	PETN1	61	key
10	LED	36	NC	62	key
11	PETN3	37	PETP1	63	key
12	+3.3V	38	DEVSLP	64	key
13	PETP3	39	GND	65	key
14	+3.3V	40	SMB_CLK	66	key
15	GND	41	PERNO/SATARPO	67	NC
16	+3.3V	42	SMD_DATA	68	SUSCLK
17	PERN2	43	PERPO/SATARN0	69	PEDET
18	+3.3V	44	ALERT#	70	+3.3V
19	PERP2	45	GND	71	GND
20	NC	46	NC	72	+3.3V
21	CFG0	47	PETNO/SATATNO	73	GND
22	NC	48	NC	74	+3.3V
23	PETN2	49	PETPO/SATATPO	75	CFG2
24	NC	50	RESET#	76	NC
25	PETP2	51	GND		
26	NC	52	NC		

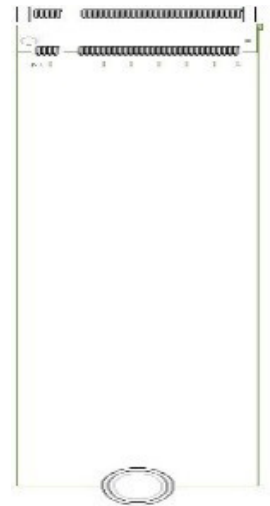

SATA3: SATA Connector (SATA DOM)

Pin	Definition	Pin	Definition
1	GND	5	RX2-
2	TX2+	6	RX2+
3	TX2-	7	NC/+5V
4	GND		



POWER1, POWER2, POWER3: Power Connector

Connector Type: 1X4-pin Wafer, 2.0 mm pitch

Pin	Definition
1	+5V
2	GND
3	GND
4	+12V

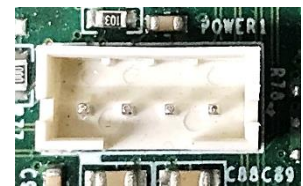

1 2 3 4

POWER4: Power Connector

Connector Type: 1X4-pin Wafer, 2.54mm pitch

Pin	Definition
1	+5V
2	GND
3	GND
4	+12V



1 2 3 4

CLR_CMOS1: Clear BIOS Switch

Pin	Definition
1-2 (Left)	Normal Status (Default)
2-3 (Right)	Clear BIOS



PWR_SW1: Power on/ off switch and Thermal LED

Button	Definition
ON	Green
OFF	Blue
Thermal	Red



LED_PH: TEMP / HDD / GPIO LED Status

LED B1	Status	LED Color
HDD LED	HDD Read/Write	Blinking Yellow
TEMP LED	System Temp $\leq 65^{\circ}\text{C}$	Colorless
	$65^{\circ}\text{C} < \text{System Temp} \leq 70^{\circ}\text{C}$	Blue
	$70^{\circ}\text{C} < \text{System Temp} \leq 75^{\circ}\text{C}$	Red
	$75^{\circ}\text{C} < \text{System Temp}$	Blinking Red

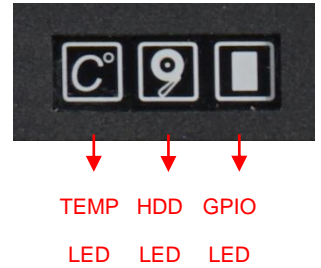

NOTE

The TEMP LED is only available when IGN module is installed.

LAN LED Status Defines

Act LED Status	Definition	Link LED Status	Definition
Blinking Yellow	Data Activity	Steady Green	1Gbps Network Link
Off	No Activity	Steady Orange	100Mbps Network Link
		Off	10Mbps Network Link

DC_IN2: DC Power Input Connector (+9-48V)

Connector Type: Terminal Block 1x3 3-pin, 5.0mm pitch

Pin	Definition
1	+9-48VIN
2	Ignition (IGN)
3	GND

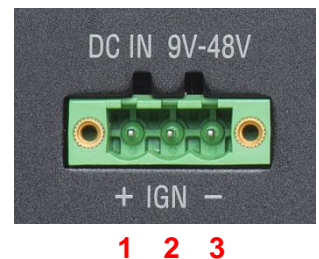

CAUTION

Please disconnect the power source before mounting the DC power cables or connecting the DC power connector to system.

FAN1: External PWM Fan Connector

Connector Type: Terminal Block 1X4 4-pin, 3.5mm pitch

Pin	Definition
1	GND
2	+12V
3	SENSE
4	Control

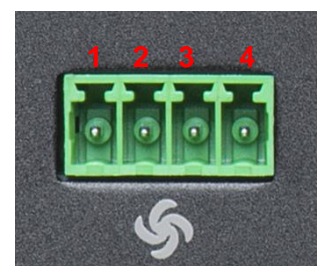

CN7: Remote Power on/off, Remote Reset Switch Connector

Connector Type: Terminal Block 2X2 4-pin, 3.5mm pitch

Pin	Definition
1	PWR_SW
2	RESET_SW
3	GND
4	GND

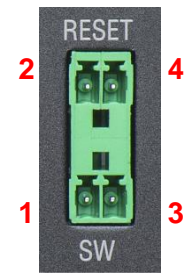

WARNING

**Do not apply power to this connector!
This port is used to connect a SWITCH!**

COM1_2_1: RS232 / RS422 / RS485 Connector

Connector Type: 9-pin D-Sub

Pin	RS232 Definition	RS422 / 485 Full Duplex Definition	RS485 Half Duplex Definition
1	DCD	TX-	DATA -
2	RXD	TX+	DATA +
3	TXD	RX+	
4	DTR	RX-	
5	GND		
6	DSR		
7	RTS		
8	CTS		
9	RI		



DC_IN1: 4 PINs DC 9-48V Power Connector



Connector Type: 2x2 4-pin, 4.2mm pitch

Pin	Definition
1	GND
2	GND
3	+9-48VIN
4	+9-48VIN



WARNING

Before using this connector, make sure that the PIN3 & PIN4 voltage meets the power requirements of the device.



Chapter 3

System Setup

This chapter takes DS-1200 as an example to demonstrate the installation of hardware components, except for chapter 3.9.

3.1 Removing Top Cover



WARNING

In order to prevent electric shock or system damage, before removing the chassis cover, must turn off power and disconnect the unit from power source.

1. Turn over the unit to have the bottom side face up, loosen the 6 screws on the bottom cover and place them aside for later use.

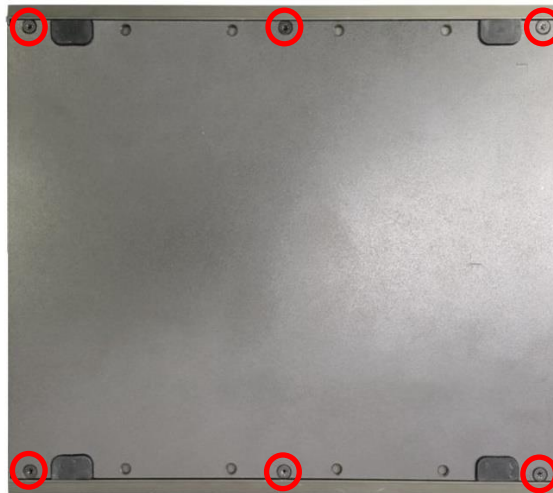

2. Remove the bottom cover from the chassis.



3. Unscrew the 2 screws at rear panel as marked on the photo and place them aside for later use.



4. Loosen the 4 screws. Pull out 4 latches as marked on the photo.

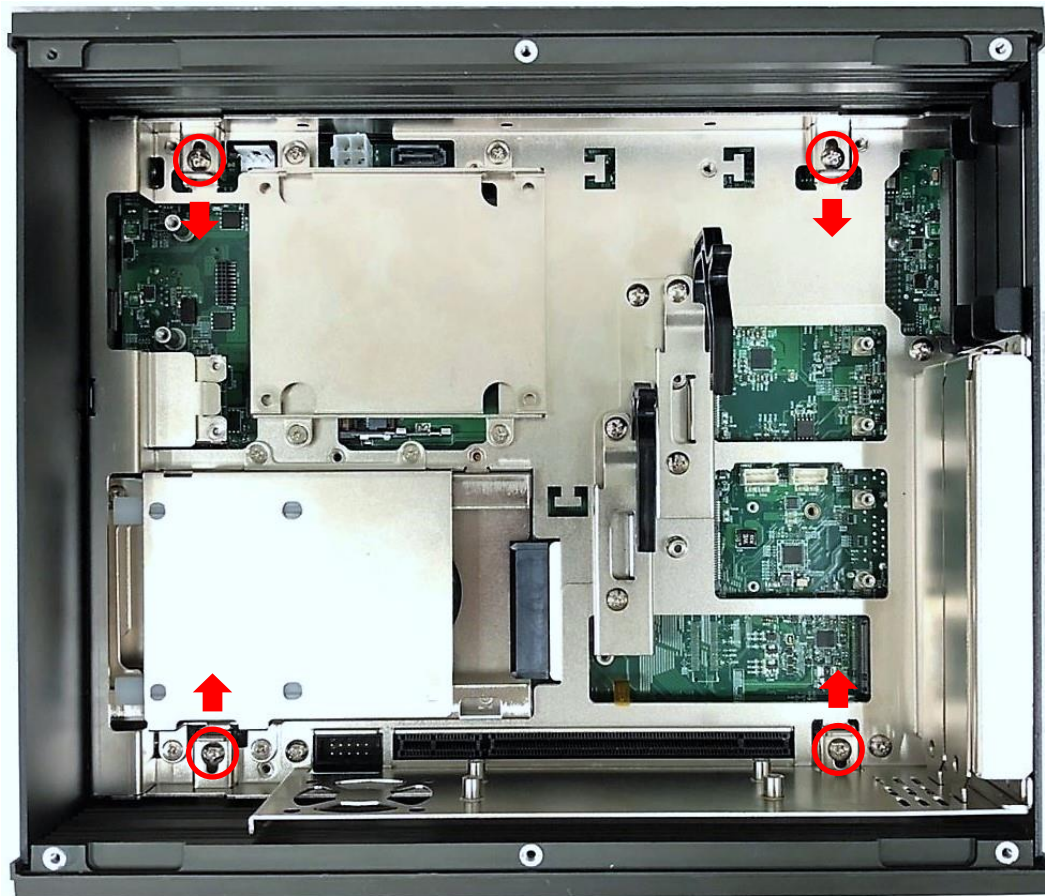

5. Lift up the unit vertically by holding the front and rear panel.

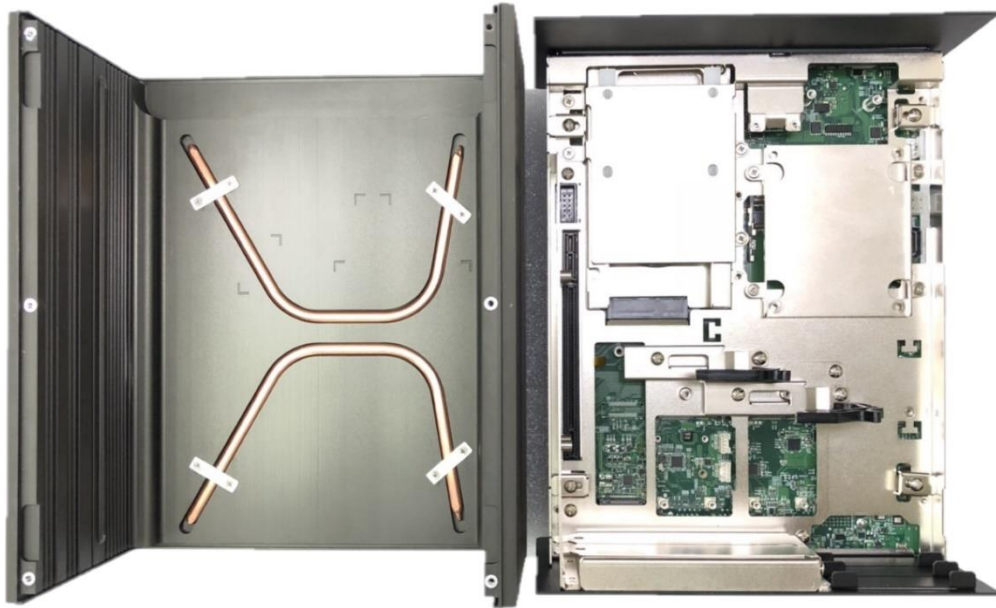

6. Turn over the body of the unit and place it gently.

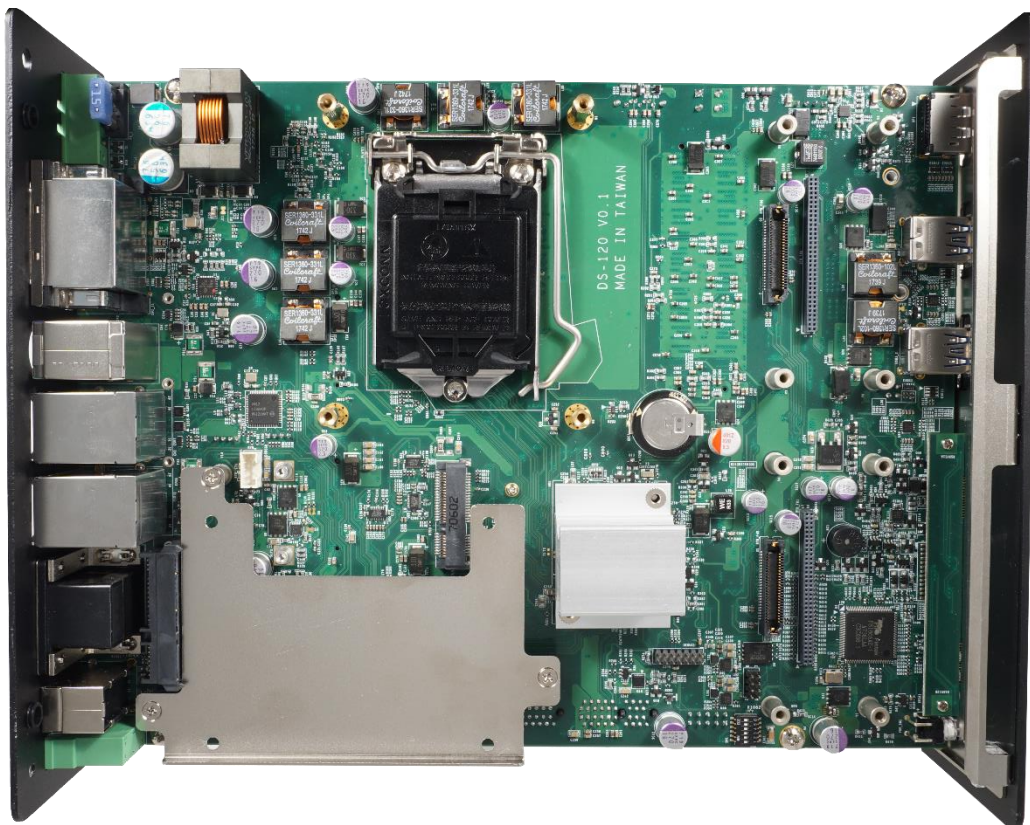

3.2 Installing CPU

1. Locate the CPU socket, remove the protection cover on it.

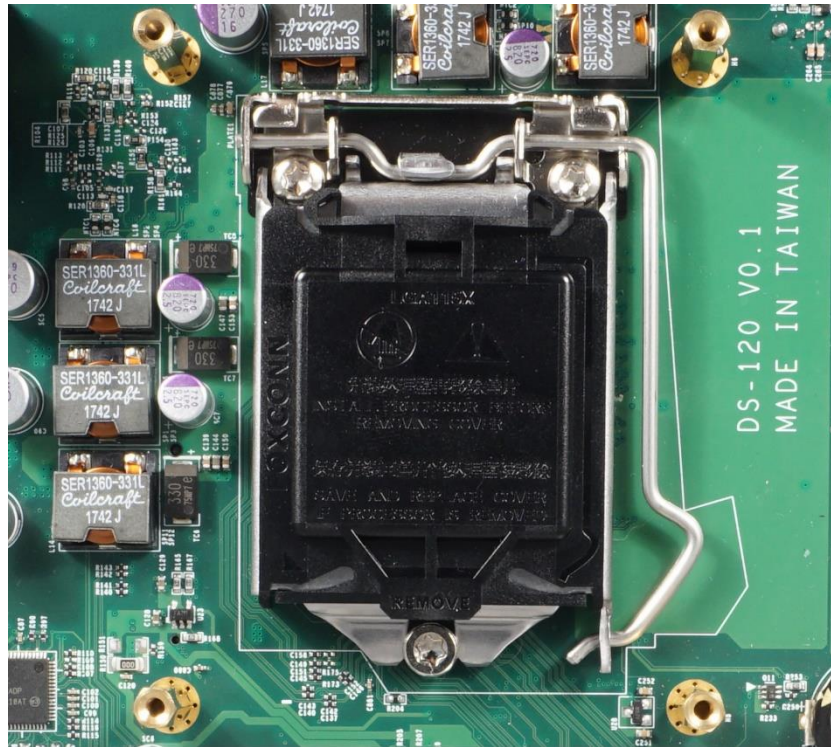

2. Press the CPU socket lever and pull it aside away from the socket to unlock it. Pull back the lever to open the socket.

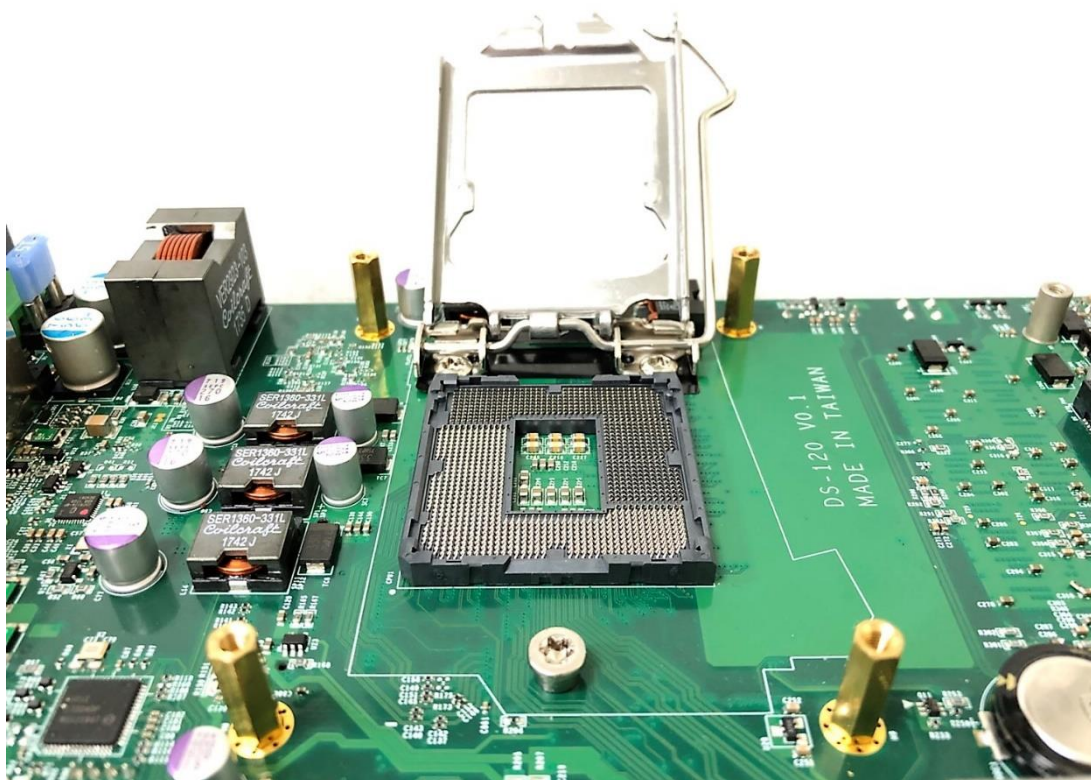

- Align the notches on CPU with the alignment post on socket.

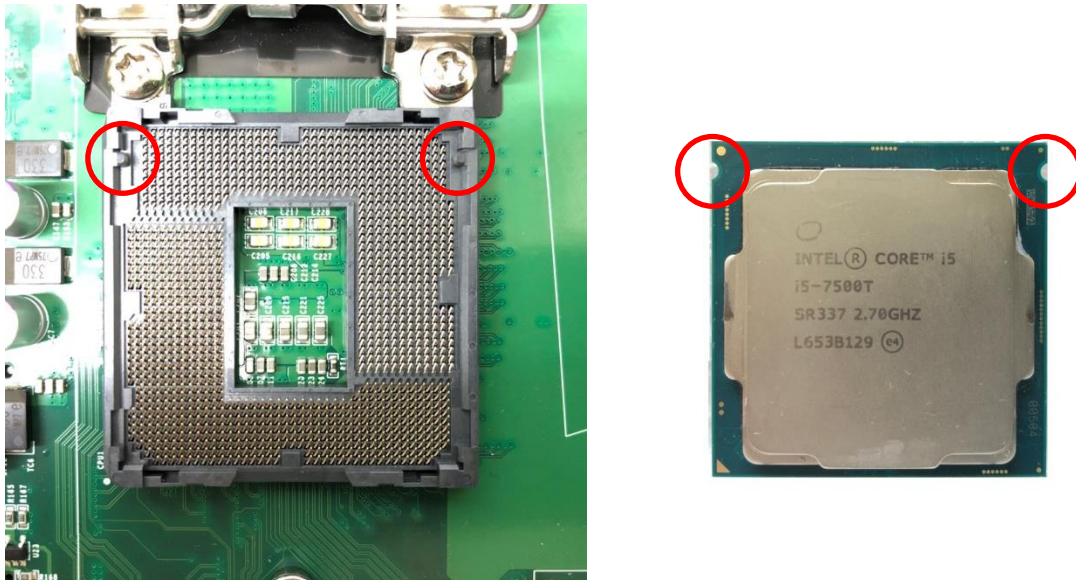

- The notches of socket provide the space for fingers while lowering the CPU, hold the CPU by the edges toward the notches and insert the CPU gently.



5. Place the thermal pad on the CPU heat spreader. Press down the socket lever to lock the CPU.



6. Align mounting holes of heatsink with the nut studs and fasten the heat sink with provided 4 screws.

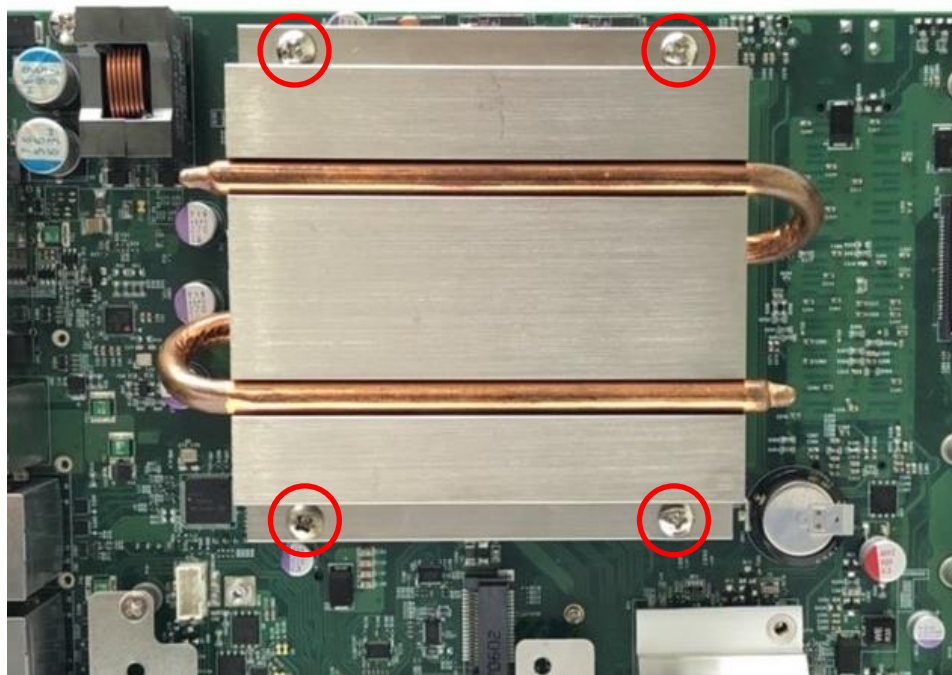

3.3 Installing SO-DIMM Memory

1. Locate the SO-DIMM sockets at the bottom side of system. Unscrews the 4 screws and remove the bracket.

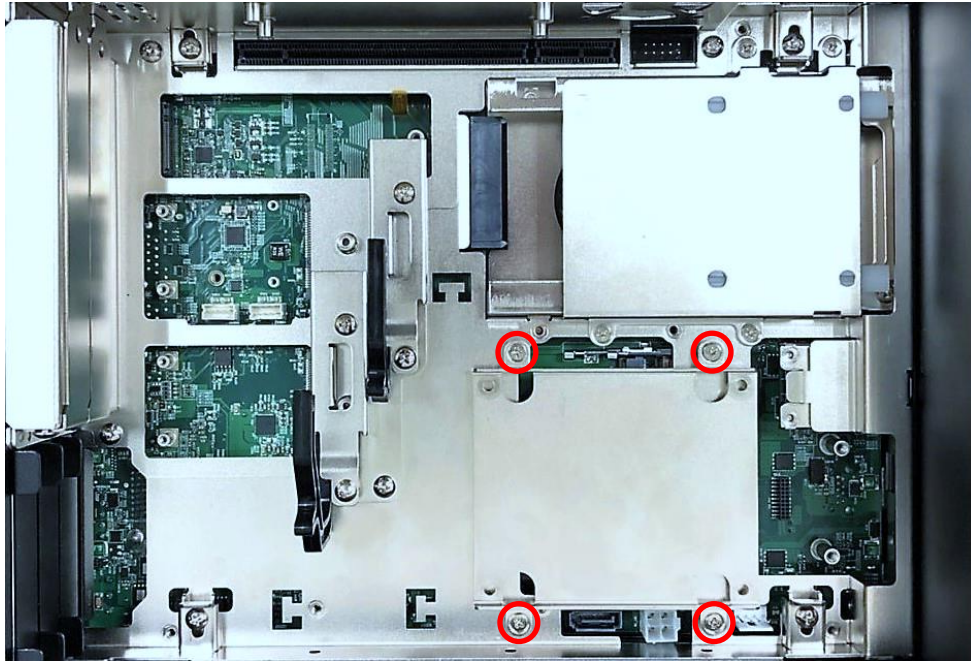

2. Locate two SO-DIMM sockets at the bottom.

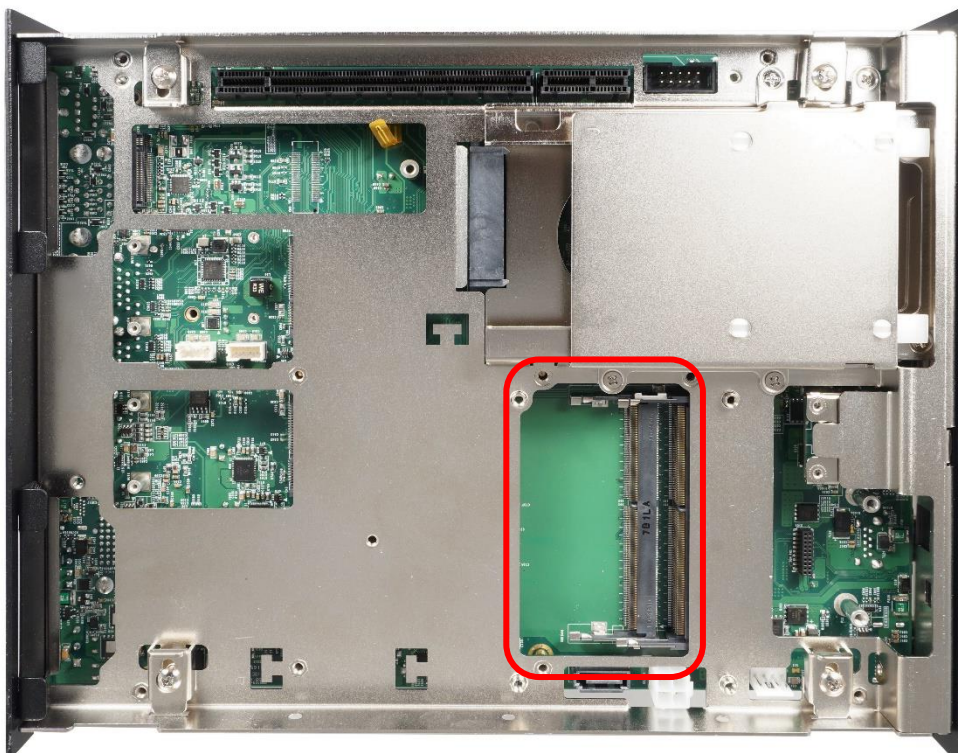

3. Tilt the SO-DIMM module at a 45-degree angle and insert it to SO-DIMM socket until the gold-pated connector of module contacted firmly with the socket.

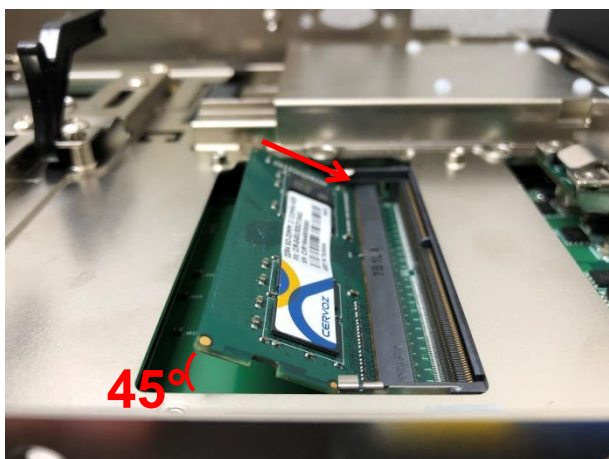

Lower socket

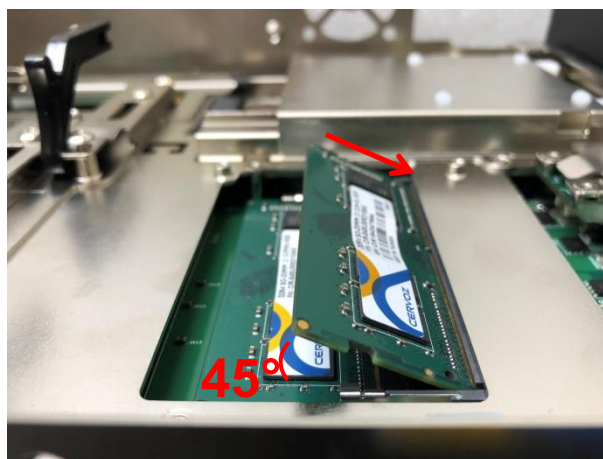

Upper socket

4. Press the modules down until it's fixed firmly by the two locking latches on the sides.



5. Put the cover back and fix the cover with 4 screws.

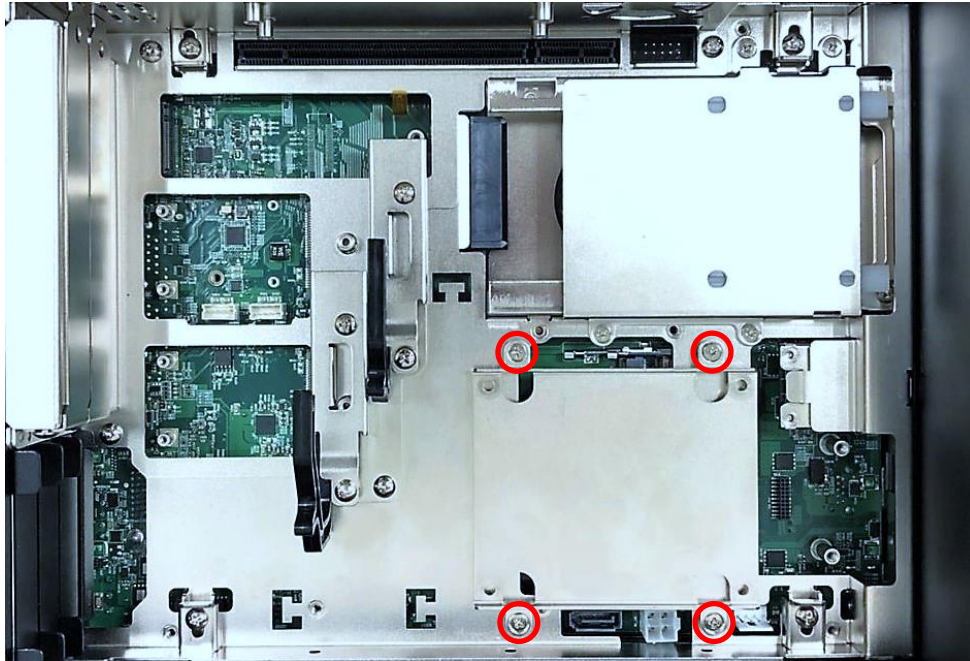

3.4 Installing Mini-PCIe/mSATA Card on Top Side

(Applicable for full or half size card)

1. Locate the Mini PCIe socket on the top side of system.

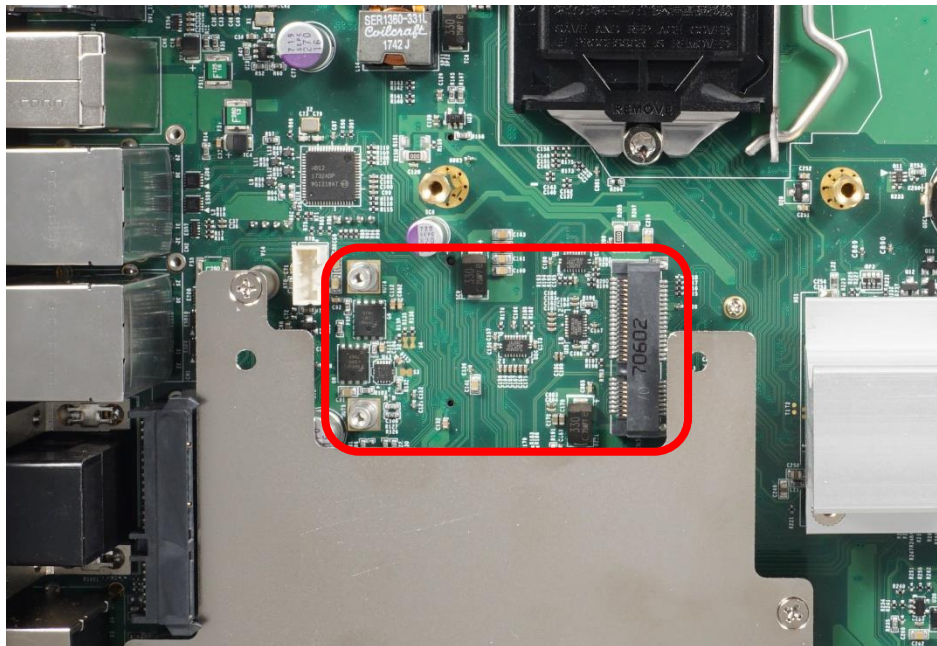

2. Use provided two screws fasten the half size module and adapter bracket together as shown in Fig (a) below.

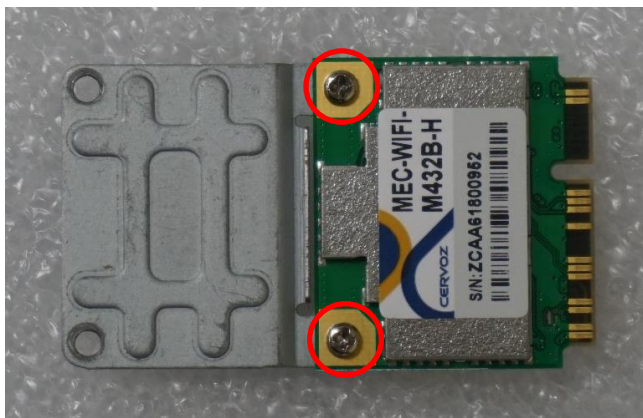

(a) Half Size Mini-PCIe Card



(b) Full Size Mini-PCIe Card

3. Insert the Mini-PCIe card at a 45-degree angle until its edge connector is connected firmly into slot.

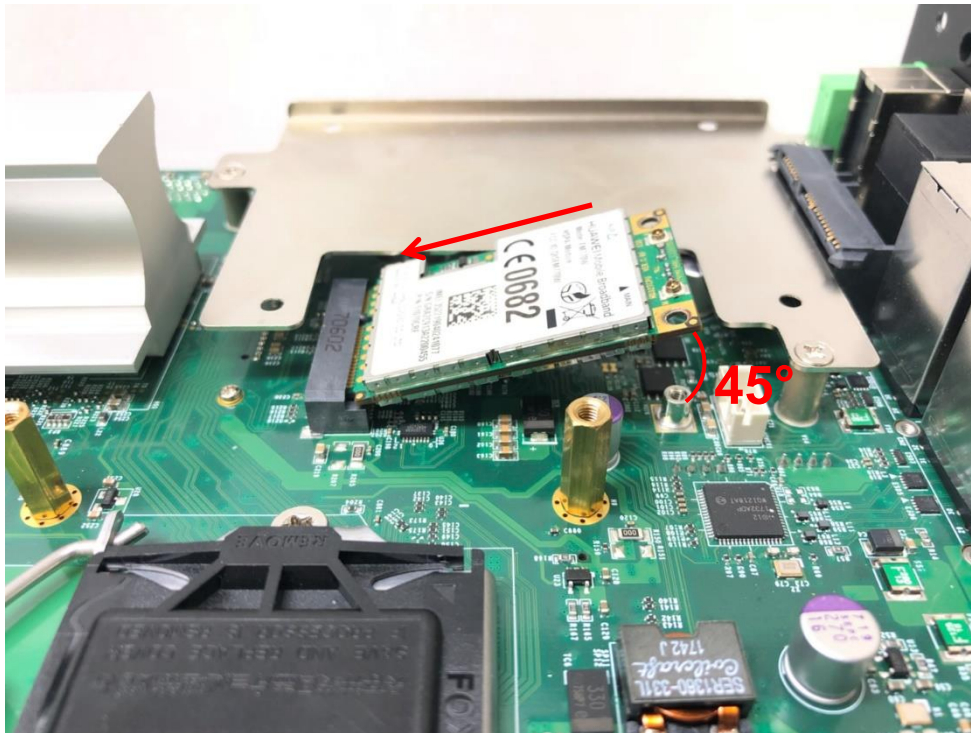

4. Press down the module and fasten two screws to secure the module.

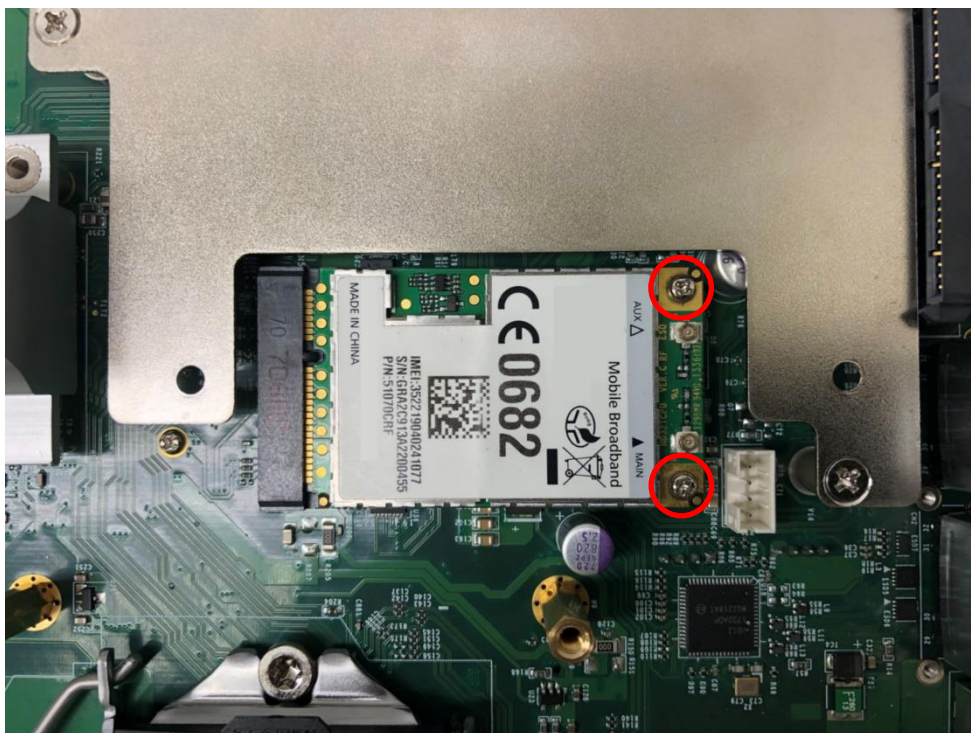

3.5 Installing Mini-PCle/mSATA Card on Bottom Side

(Applicable for full or half size card)

1. Turn over the body of the unit. Locate Mini-PCle (mSATA) slots at the bottom.

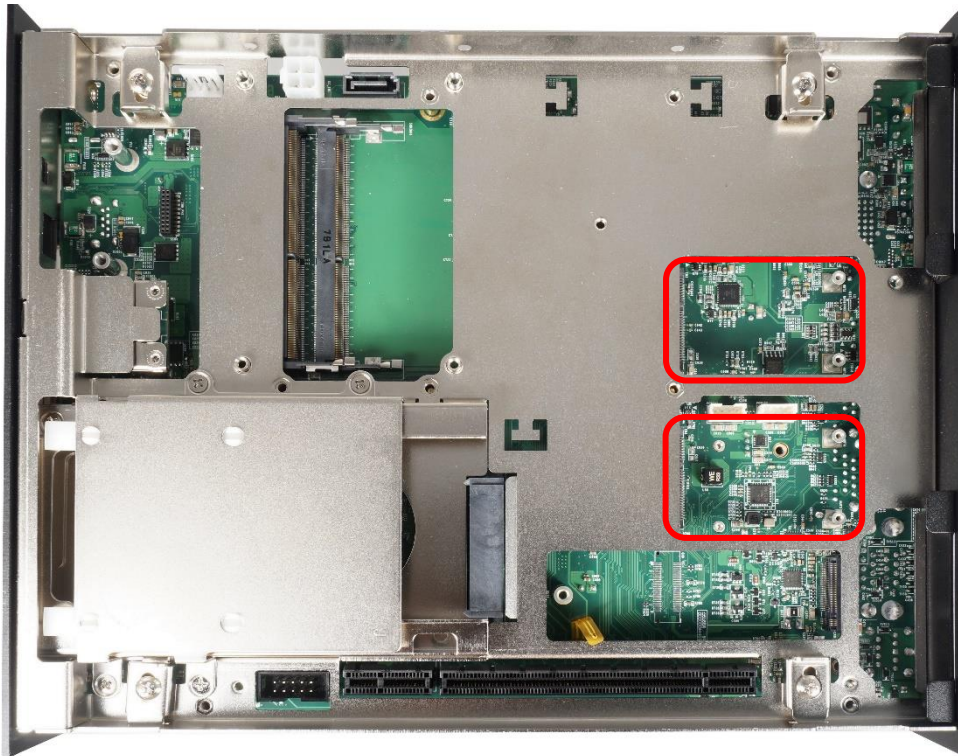

2. Tilt the Mini-PCle module at a 45-degree angle and insert it to the slot until the gold-pated connector of module contacted firmly with the slot.

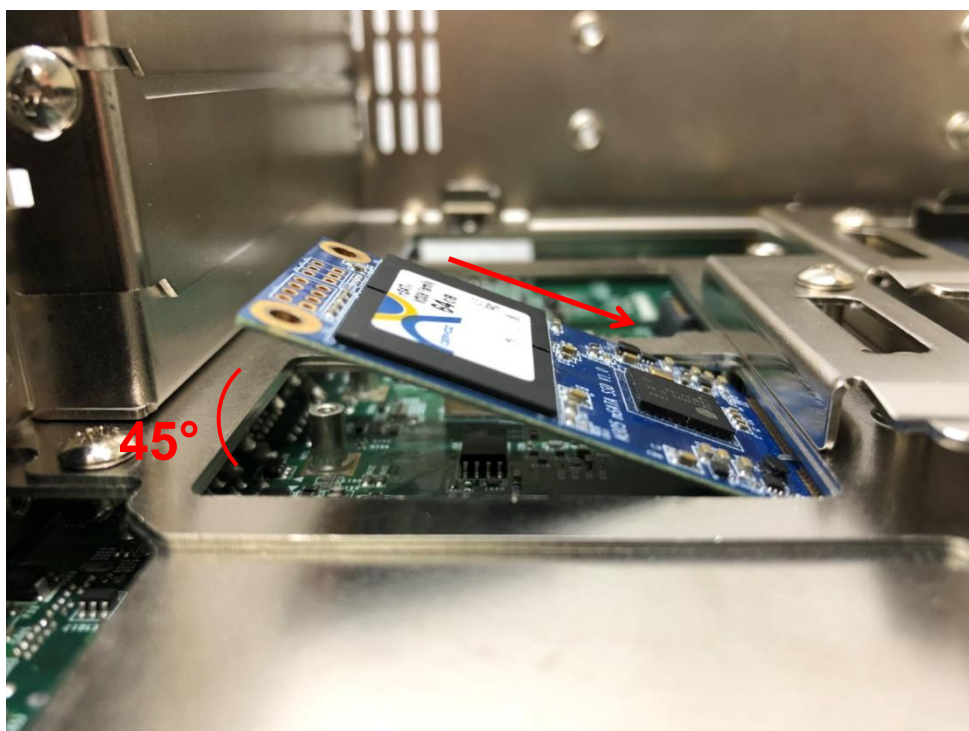

3. Press down the module and use previous two screws to fix the module.

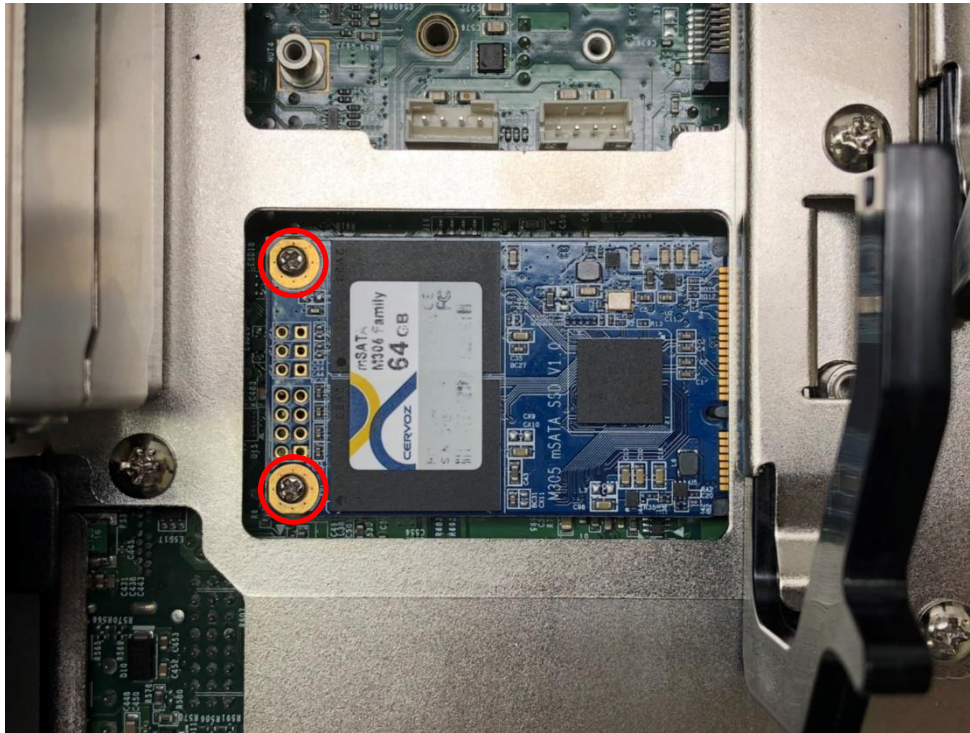

3.6 Installing Antenna(s)

1. Remove the antenna rubber covers on rear panel.



2. Have antenna jack penetrate through the hole.



3. Put on washer and fasten the nut with antenna jack.



4. Assemble the antenna and antenna jack together.



5. Attach the RF connector at another end of cable onto the module.



3.7 Installing SATA Hard Drive on Top Side

1. Unscrew the 3 screws on HDD bracket and remove the bracket.

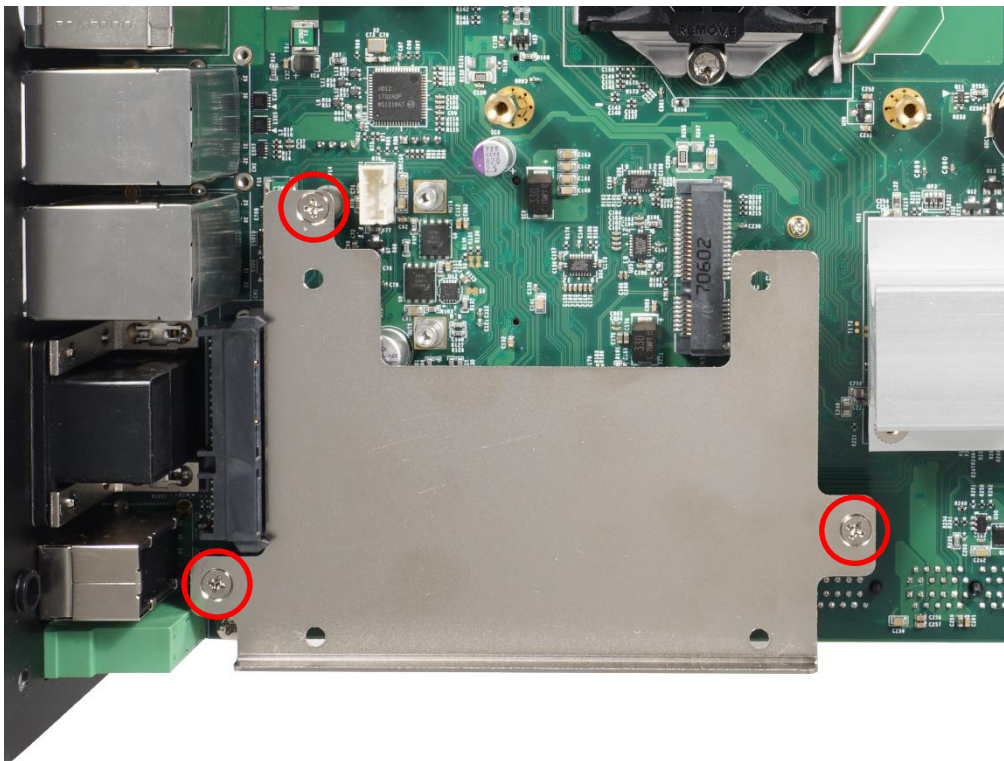

2. Make the PCB side of the HDD face up, place the HDD bracket on it. Ensure the direction of bracket is correct and use 4 provided screws to assemble HDD and HDD bracket together.

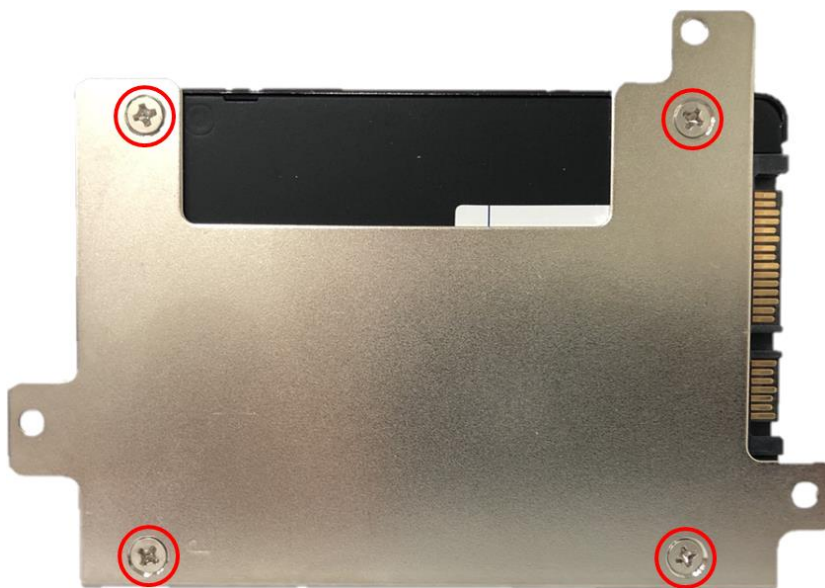

3. Turn over the HDD bracket. Connect the HDD bracket to the SATA connector and fasten the 3 screws.

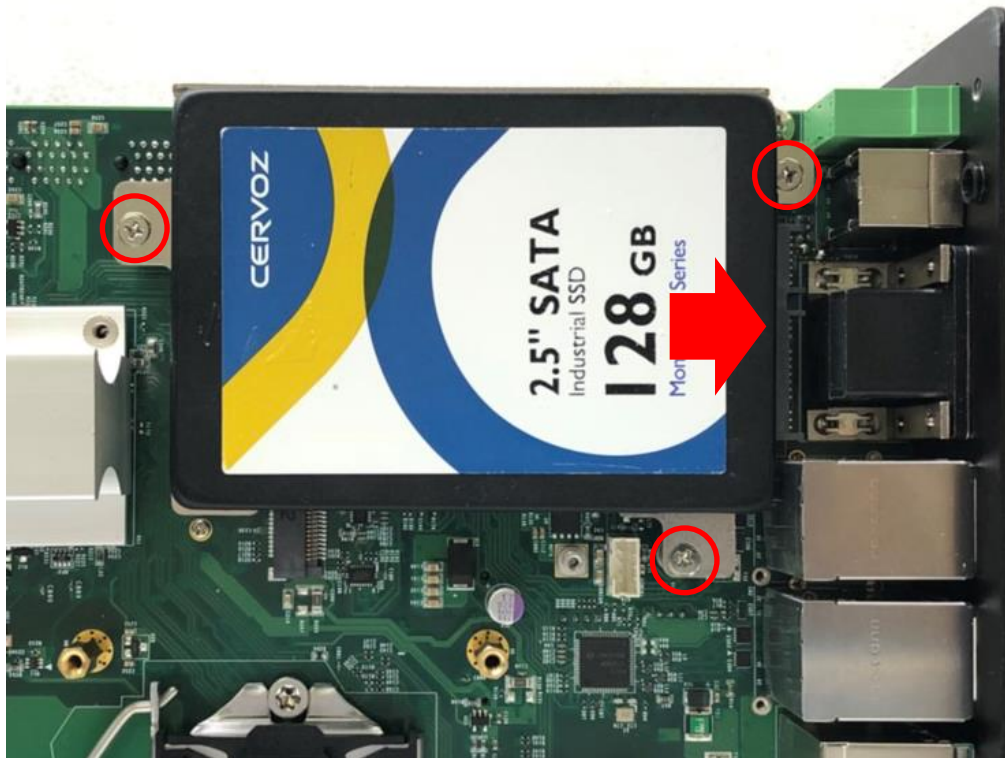

3.8 Installing M.2 Card

1. Turn over the body of the unit. Unscrew the 2 screws and remove the bracket.

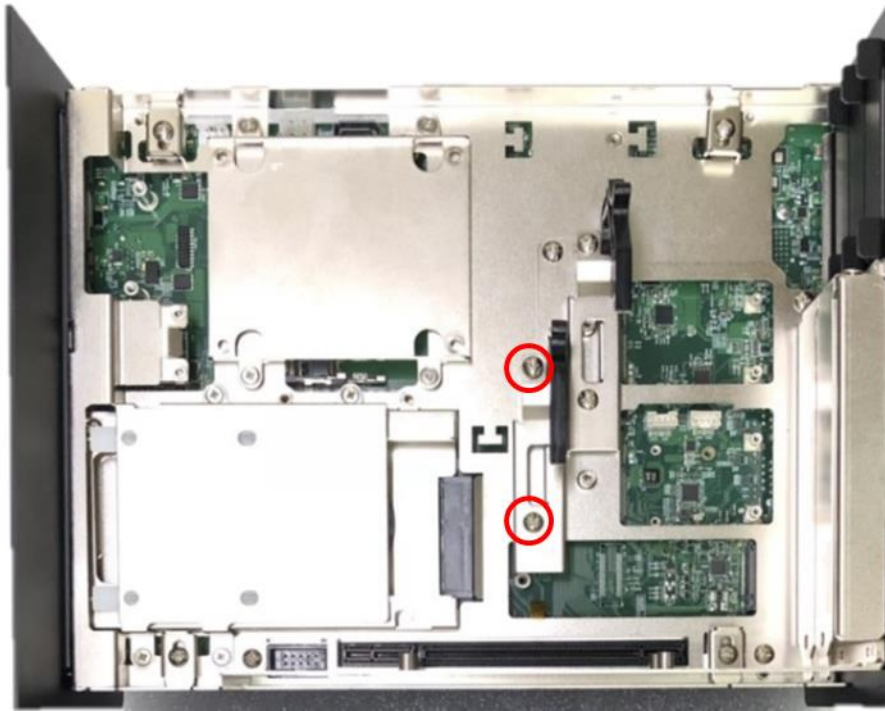

2. Locate M.2 slots at the bottom.

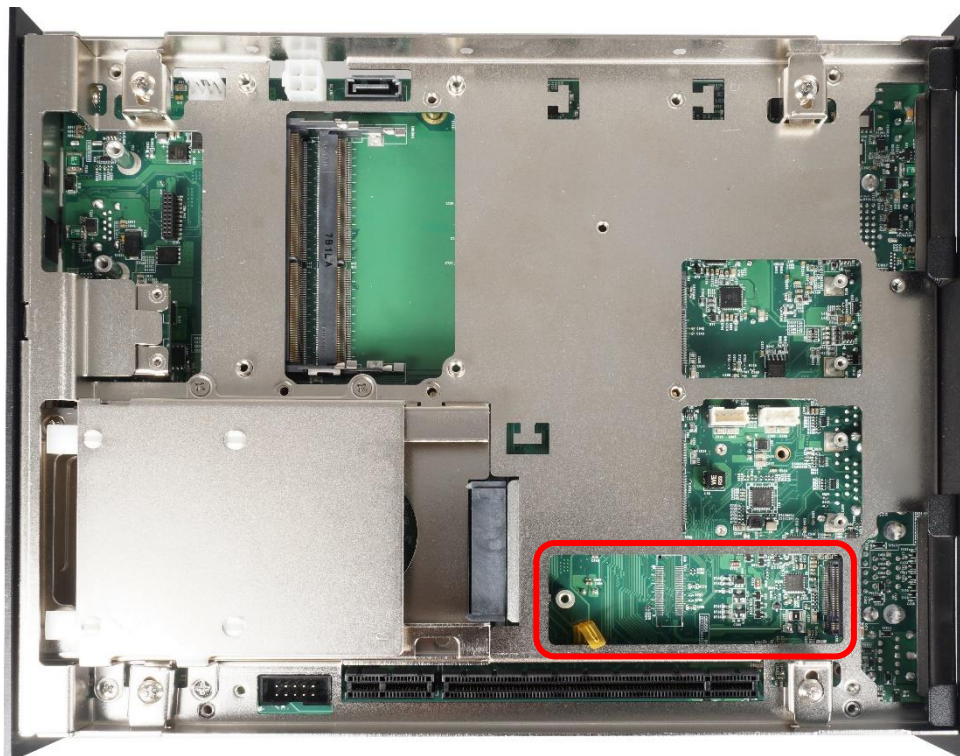

3. Tilt the M.2 M Key card at a 45-degree angle and insert it to the slot until the gold-pated connector of module contacted firmly with the slot.

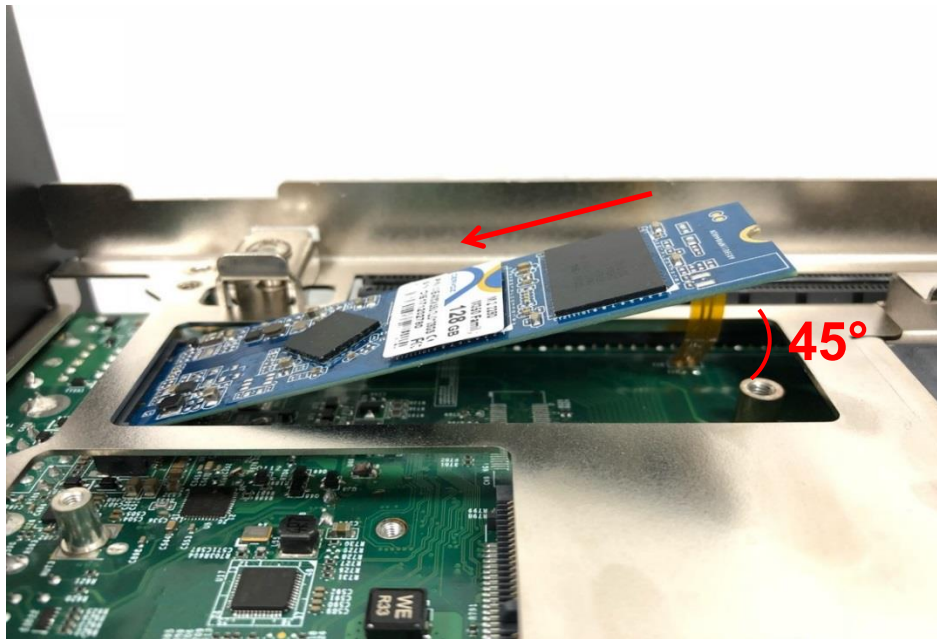

4. Press down the module and use previous one screw to fix the module.



3.9 Installing PCI/PCIe Add-on Card

(For DS-1201 and DS-1202 only)

The applicable riser cards for DS-1200 series are listed in the following table.

Model No.	Description	Compatible Model
RC-E16-01	Riser Card 1 x PCIe16	DS-1201
RC-PI-01	Riser Card 1 x PCI	DS-1201
RC-E16E1-01	Riser Card 1 x PCIe16, 1 x PCIe1	DS-1202
RC-E8E8-R10	Riser Card 2 x PCIe8	DS-1202
RC-E16PI-01	Riser Card 1 x PCIe16, 1 x PCI	DS-1202
RC-PIPI-01	Riser Card 2 x PCI	DS-1202



NOTE

The photo example in this section is illustrated by **RC-E16PI-01 module.**

1. Prepare a Riser Card intended for installation.



Riser Card RC-E16PI-01

2. Unscrew the 4 screws to remove the extension bracket.

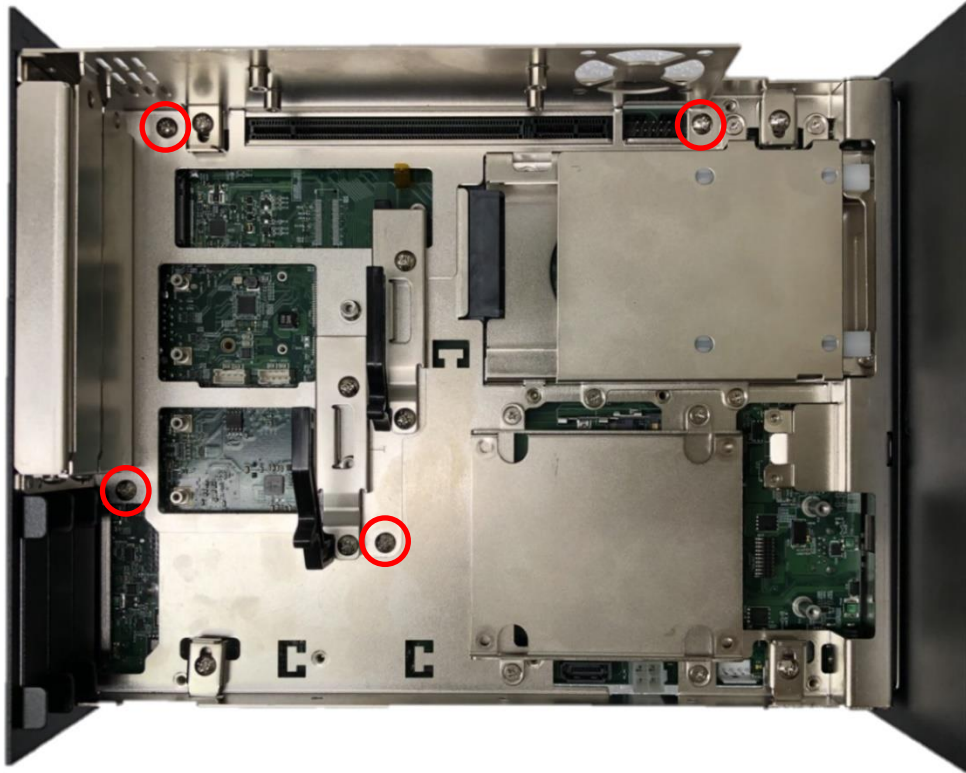

3. Remove the extension bracket from the system.

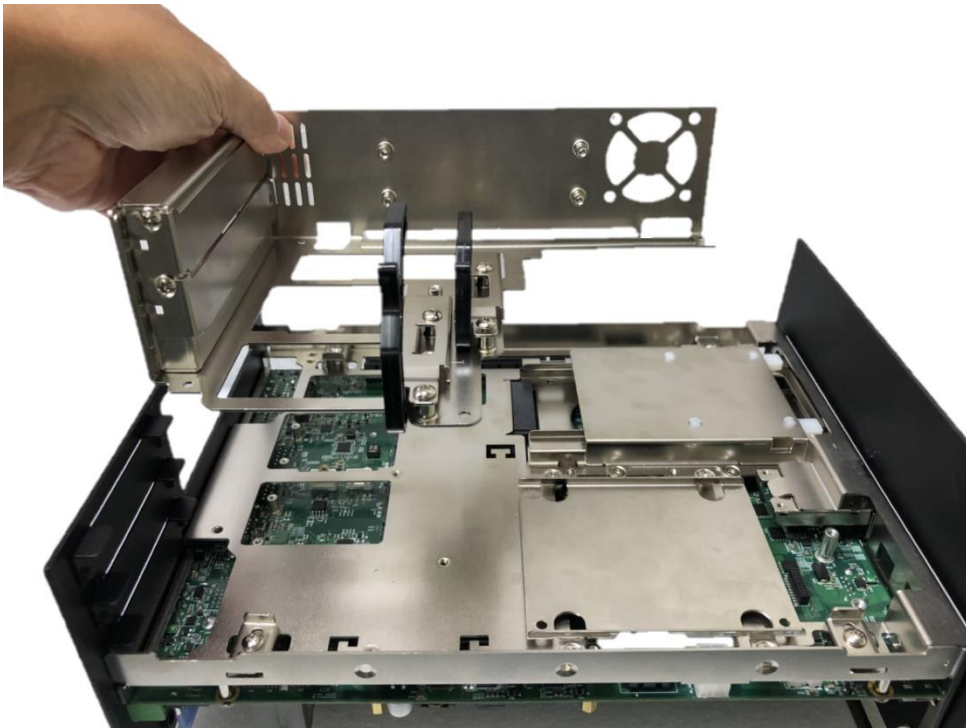

4. Assemble the riser card with extension bracket together and fasten with the 4 screws.

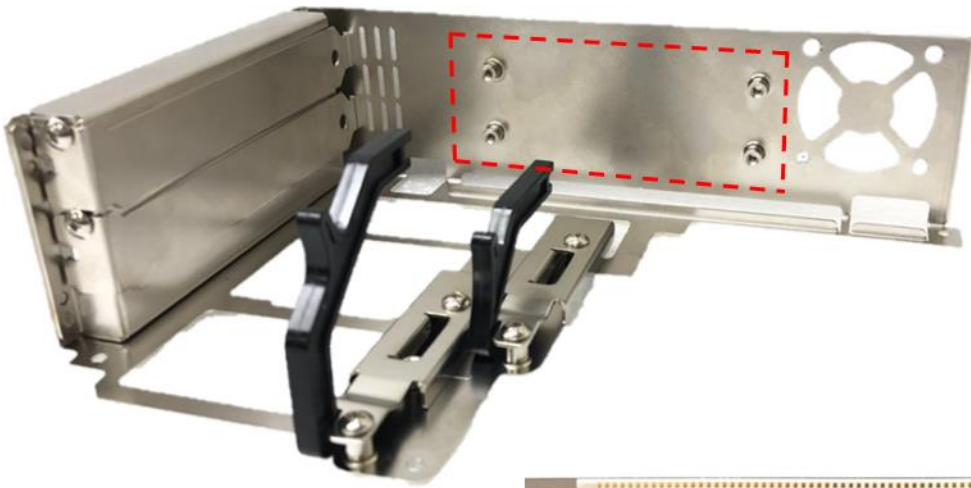

Extension Bracket

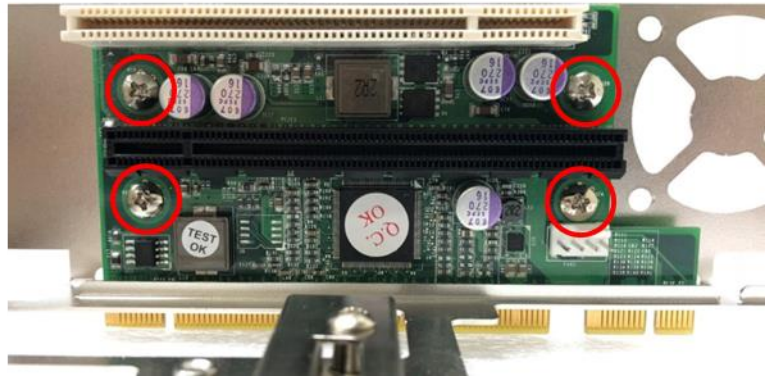

5. (1) Loosen the screw to remove I/O bracket. (2) Loosen the 2 screws halfway to allow the card retainer to be adjustable.

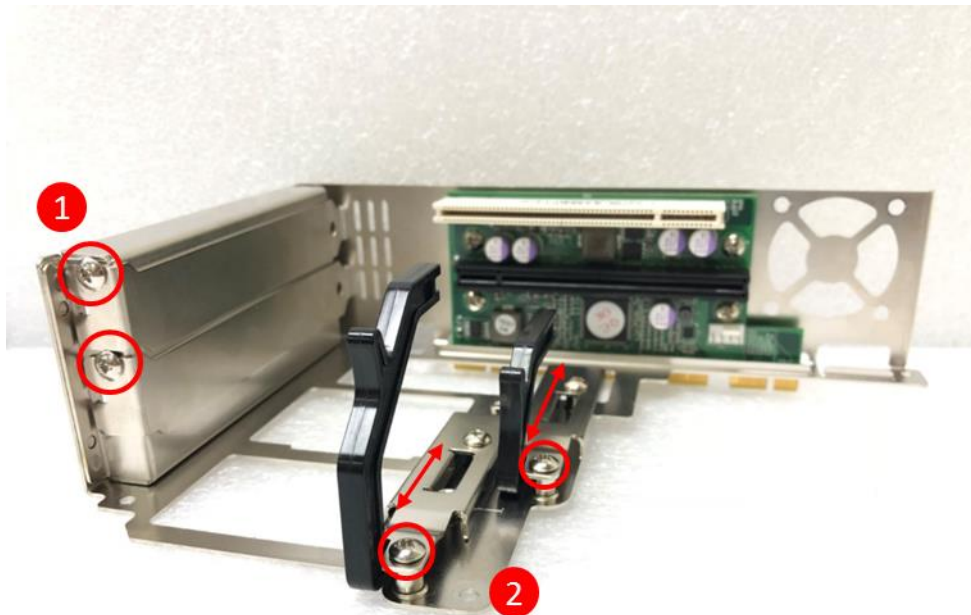

6. (1) Insert a PCI(e) add-on card to the slot. (2) Fasten the screw to secure it (3) Push the card retainer forward to against the edge of the add-on card. (4) Tighten the screw to fix the card retainer.

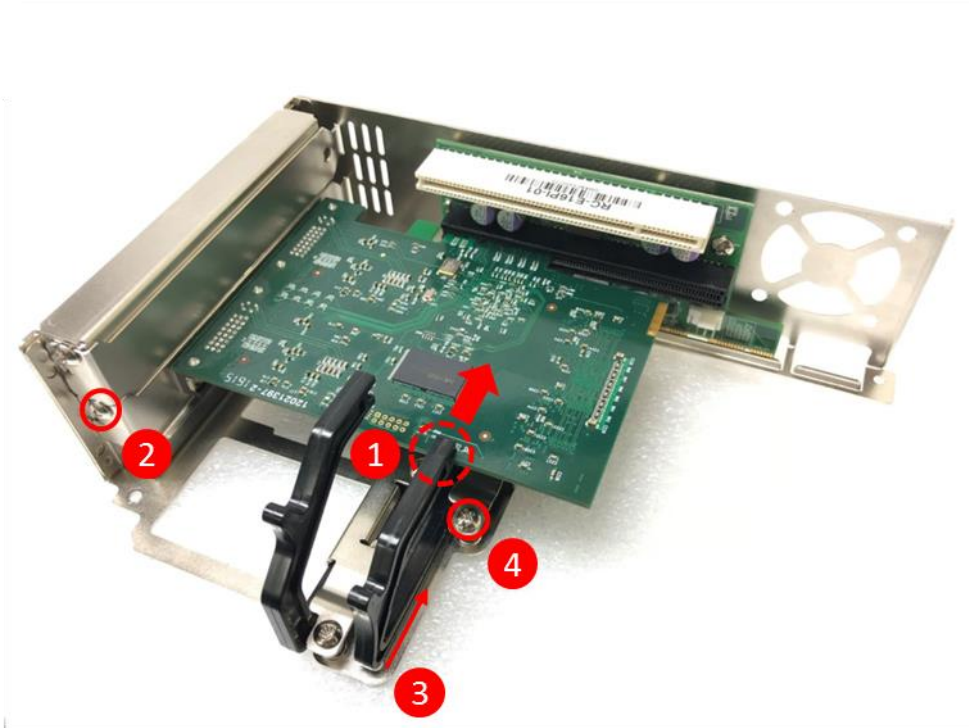

7. Locate the riser card slot on bottom side of system.

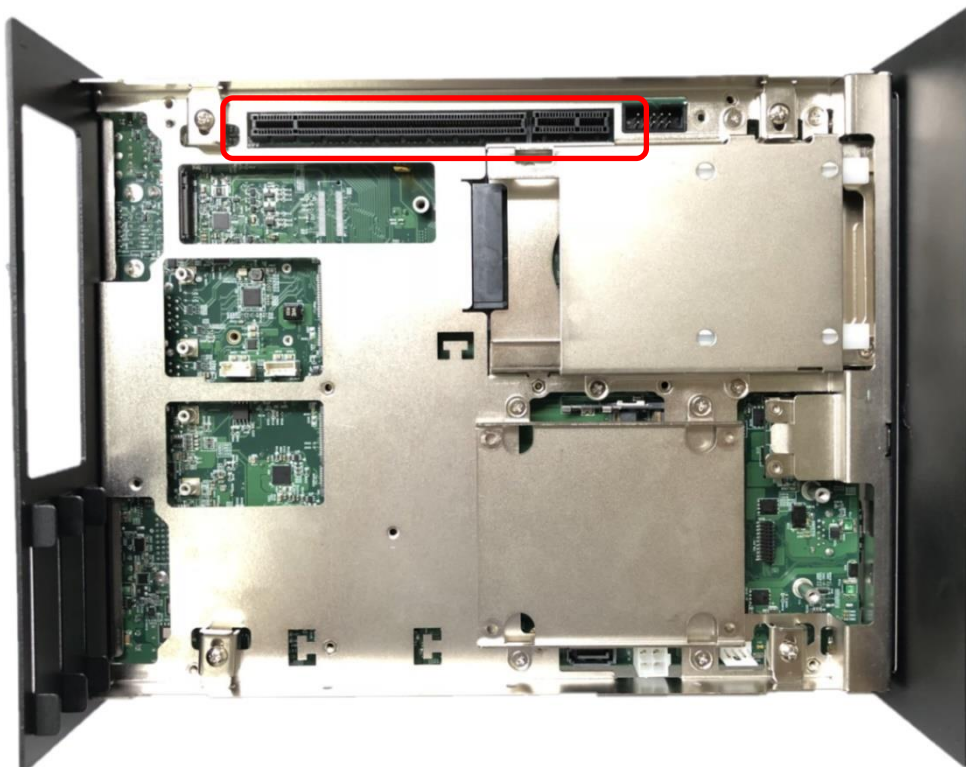

8. Install the module assembled in step 4 into the riser card slot, and fasten the 4 screws to secure it.

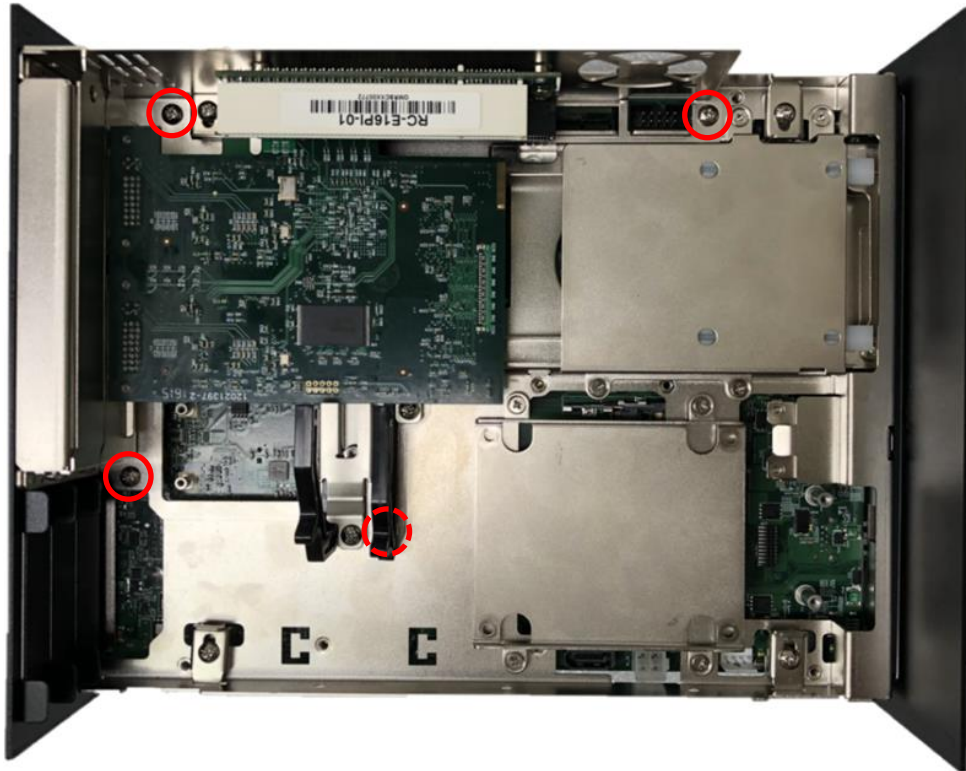

3.10 Installing Top Cover

1. Make sure the notch on chassis and the front bezel of body are at the same side.

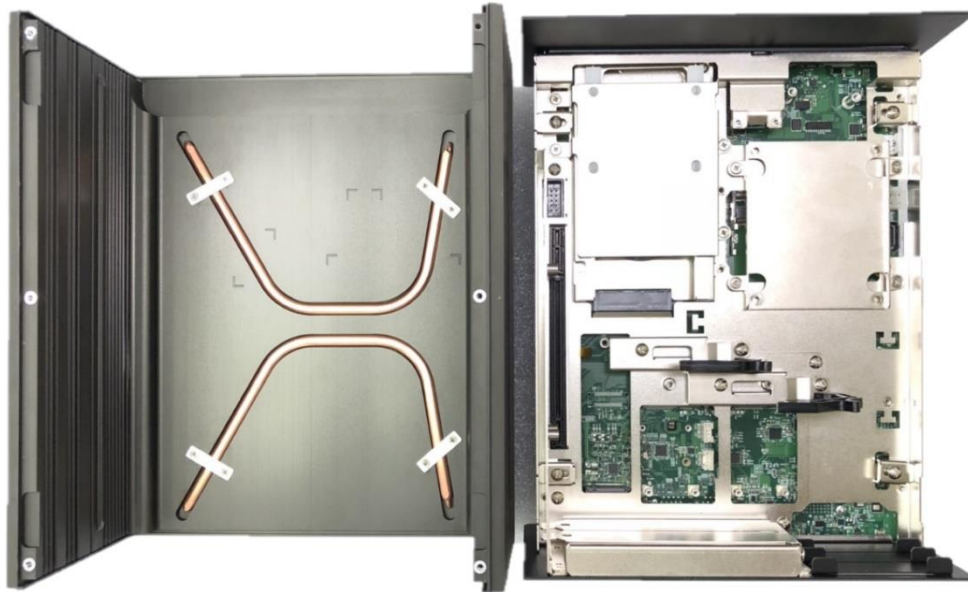

2. Lift up the body of unit. Make sure that both front and rear panels are in the chassis grooves and assemble the body on to chassis firmly.

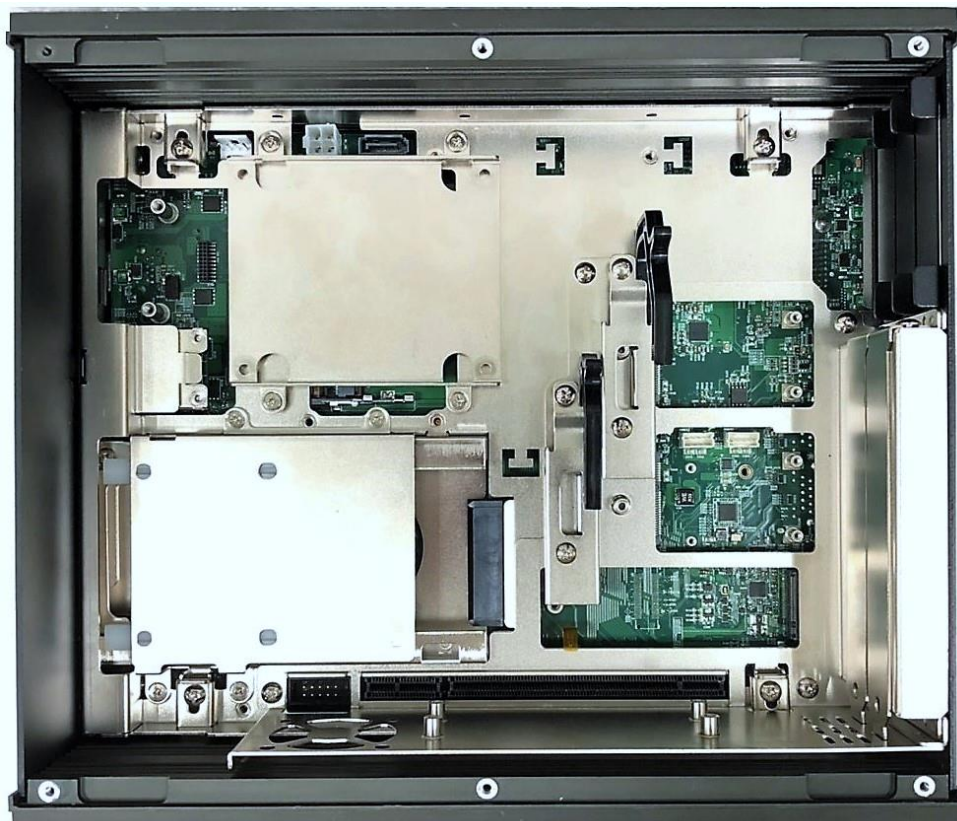

3. Push into the 4 latches as indicated and fasten the 4 screws.

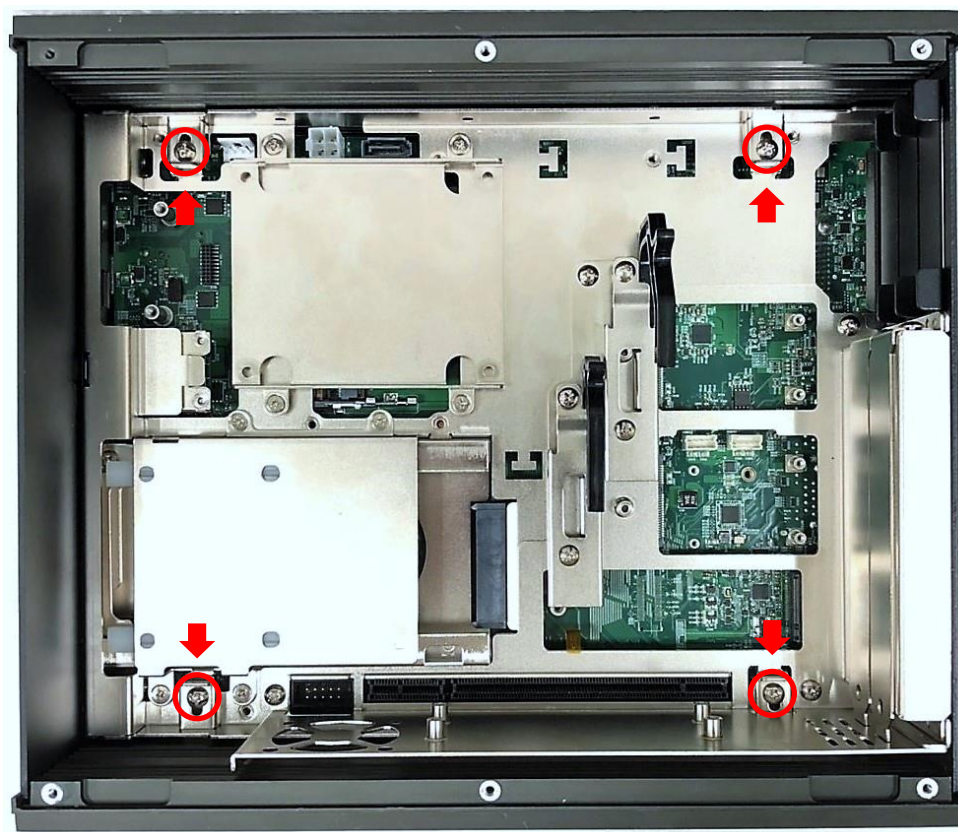

4. Fasten the 2 screws at rear panel.



5. Be sure to align the grooves with front and rear panels. Put the cover back on and fasten the 6 screws to fix the cover.

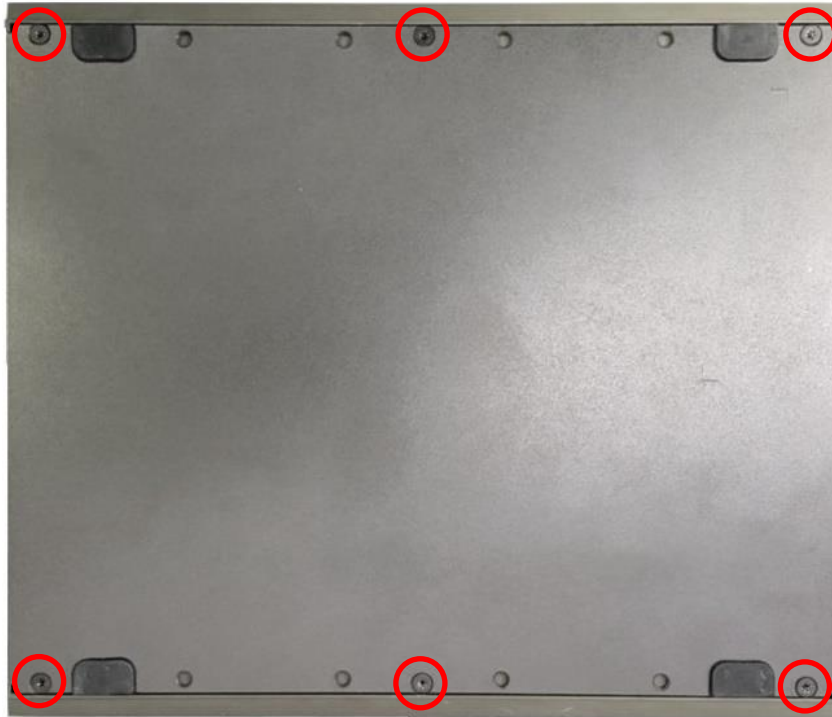

3.11 Removing Maintenance Cover

1. Loosen the screws in order to remove the front expansion plate.



3.12 Installing SATA Hard Drive at Front Side

1. Locate the removable HDD bay and loosen the screw.

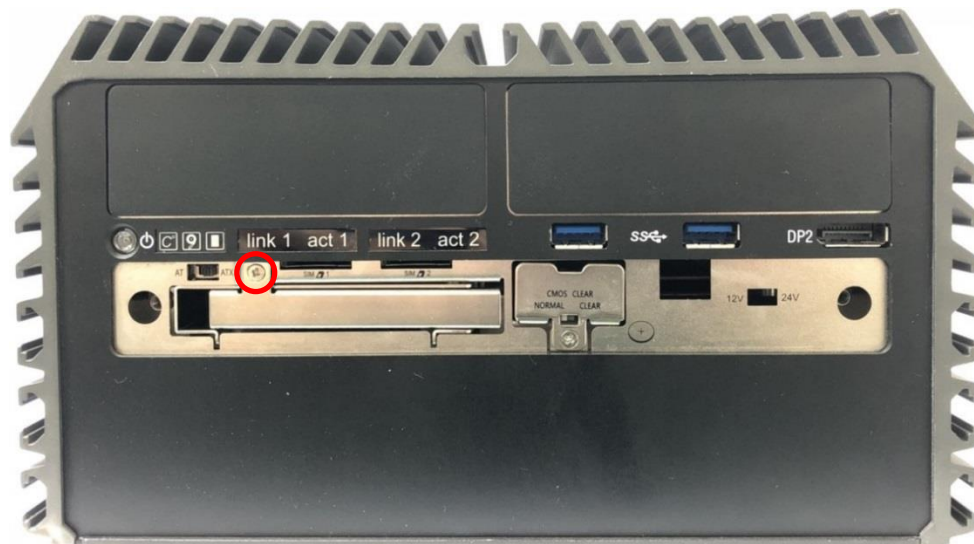

2. Move the rotating arm out and pull the HDD bracket out.



3. Make the PCB side of the HDD face up, place the HDD bracket into it. Ensure the direction of bracket is correct and use 4 provided screws to assemble HDD and HDD bracket together.



- Align the HDD bracket with the entrance of HDD bay. Holding the rotating arm and insert the HDD bracket until the connector of HDD contact the SATA connector firmly.



- Place the rotating arm back and fasten the screw.



3.13 Installing SIM Card

1. Locate the SIM card slot at front side.

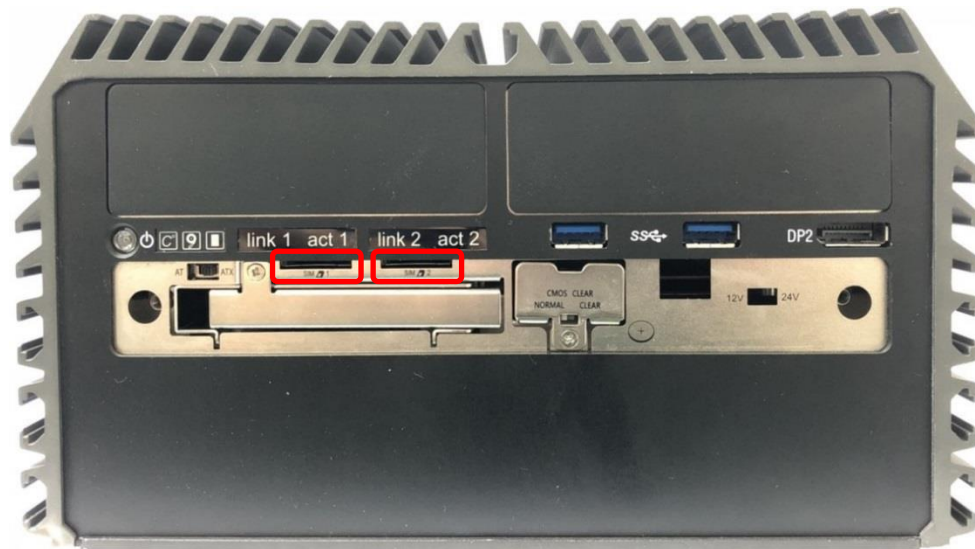

2. Insert the SIM card according to the icon instruction aside.

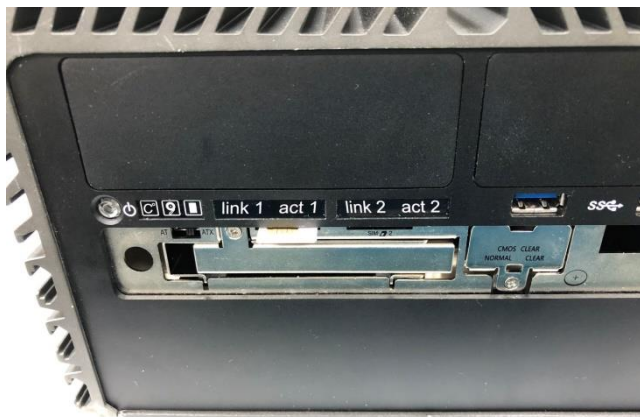

SIM 1

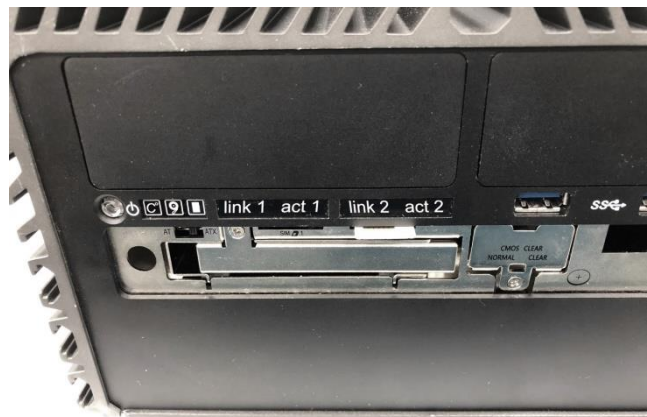

SIM 2

3.14 Installing CMOS Battery

1. Locate the removable CMOS Battery and loosen the screw.

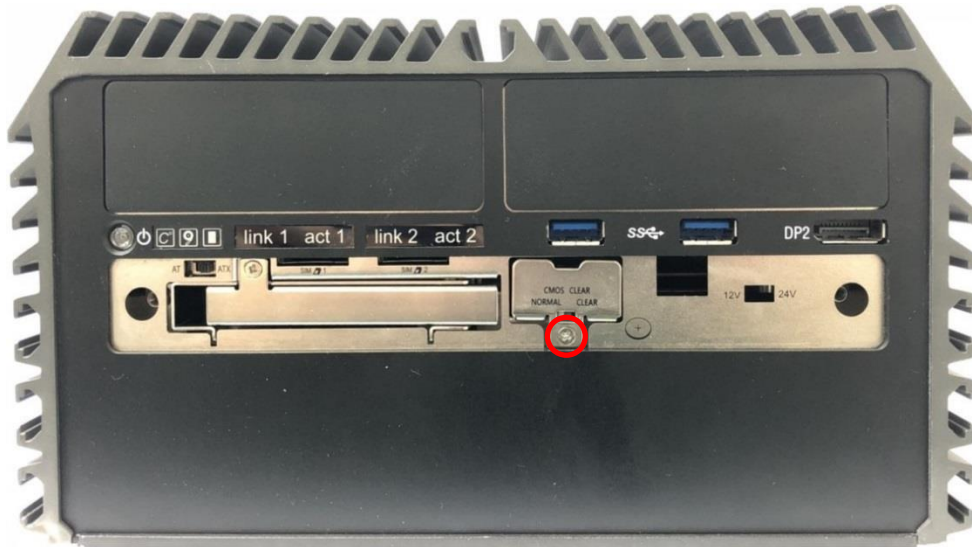

2. Pull out the CMOS battery bracket with assistance of a tweezer.

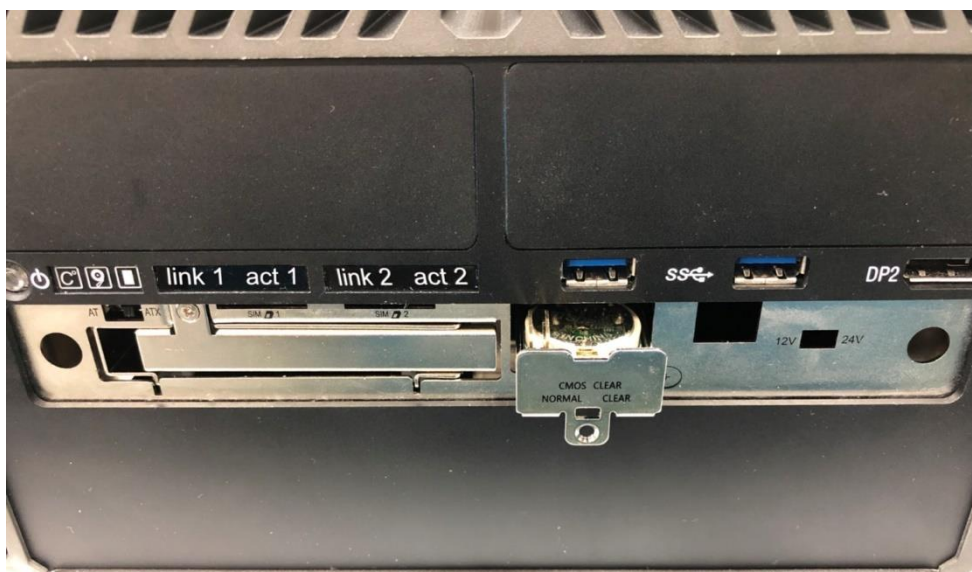

3. Insert a CMOS battery in the battery slot.

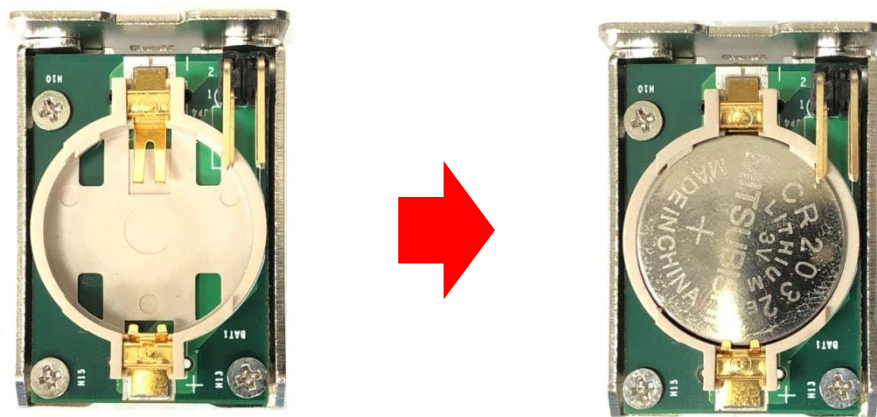

4. Insert the battery bracket firmly and fasten the screw.



3.15 Installing Maintenance Cover

1. Fasten the cover by using the two screws.



3.16 Installing Wall Mount Brackets

DS-1200 series offers wall mount that customers can install system on the wall in convenient and economical ways.





1. The mounting holes are at the bottom side of the system. Use the provided 8 screws to fasten the bracket and the system together.

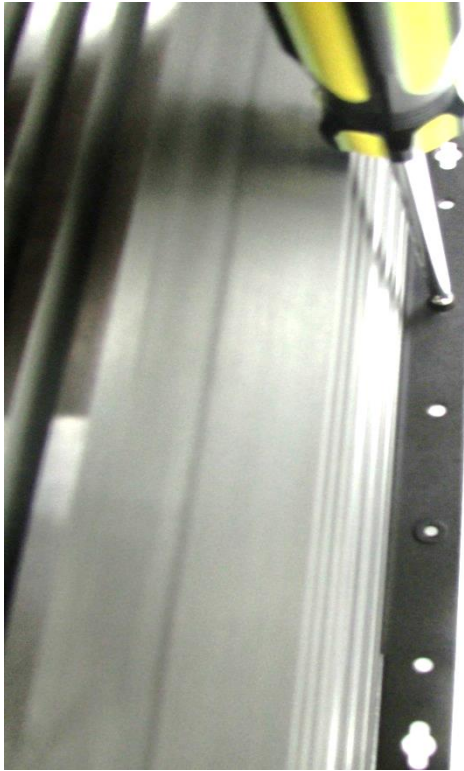

2. Fasten the screws through the bracket mounting hole to mount system on the wall.





Chapter 4

BIOS Setup

4.1 BIOS Introduction

The BIOS (Basic Input/ Output System) is a program located on a Flash Memory on the motherboard. When you start the computer, the BIOS program will gain control. The BIOS first operates an auto-diagnostic test called POST (power on self-test) for all the necessary hardware, it detects the entire hardware device and configures the parameters of the hardware synchronization.

BIOS Setup

Power on the computer and by pressing immediately allows you to enter Setup. If the message disappears before your respond and you still wish to enter Setup, restart the system to try again by turning it OFF then ON or pressing <Ctrl>, <Alt> and <Delete> keys.

Control Keys	
<←> <→>	Move to select screen
<↑> <↓>	Move to select item
<Esc>	Quit the BIOS Setup
<Enter>	Select item
<Page Up/+>	Increases the numeric value or makes changes
<Page Down/->	Decreases the numeric value or makes changes
<Tab>	Select setup fields
<F1>	General help
<F2>	Previous value
<F3>	Load Optimized defaults
<F10>	Save configuration and Exit

Main Menu

The main menu lists the setup functions you can make changes to. You can use the arrow keys (↑↓) to select the item. The on-line description of the highlighted setup function is displayed at the bottom of the screen.

Sub-Menu

If you find a right pointer symbol appears to the left of certain fields that means a sub-menu can be launched from this field. A sub-menu contains additional options for a field parameter. You can use arrow keys (↑↓) to highlight the field and press <Enter> to call up the sub-menu. Then you can use the control keys to enter values and move from field to field within a sub-menu. If you want to return to the main menu, just press the <Esc >.

4.2 Main Setup

Press to enter BIOS CMOS Setup Utility, the Main Menu (as shown below) will appear on the screen. Use arrow keys to move among the items and press <Enter> to accept or enter a sub-menu.

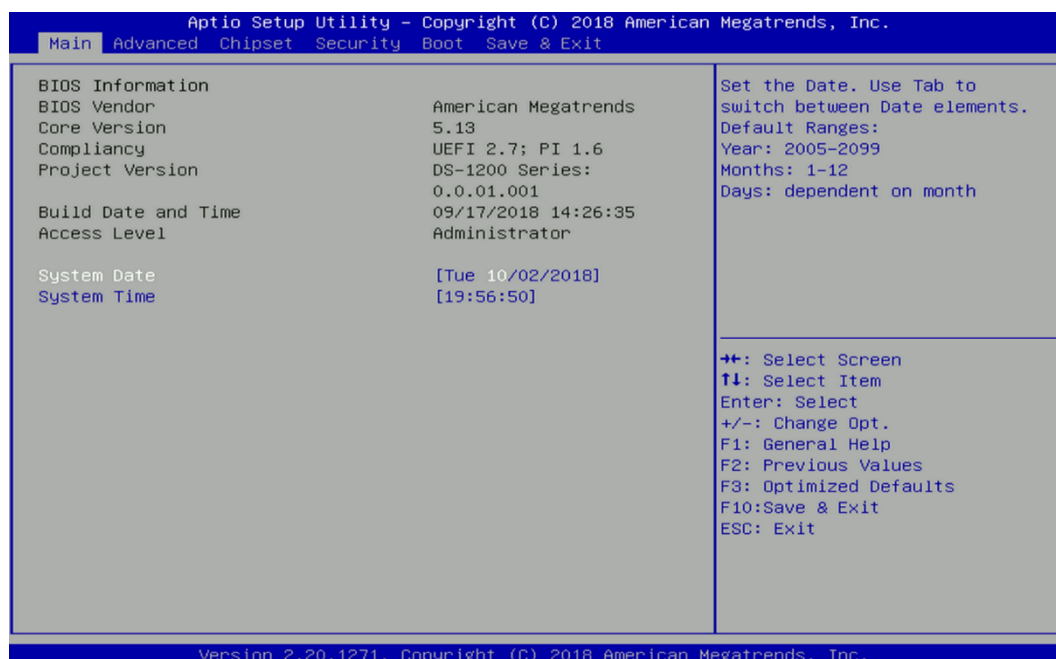

4.2.1 System Date

Set the date. Please use <Tab> to switch between date elements.

4.2.2 System Time

Set the time. Please use <Tab> to switch between time elements.

4.3 Advanced Setup

This section allows you to configure and improve your system and allows you to set up some system features according to your preference.

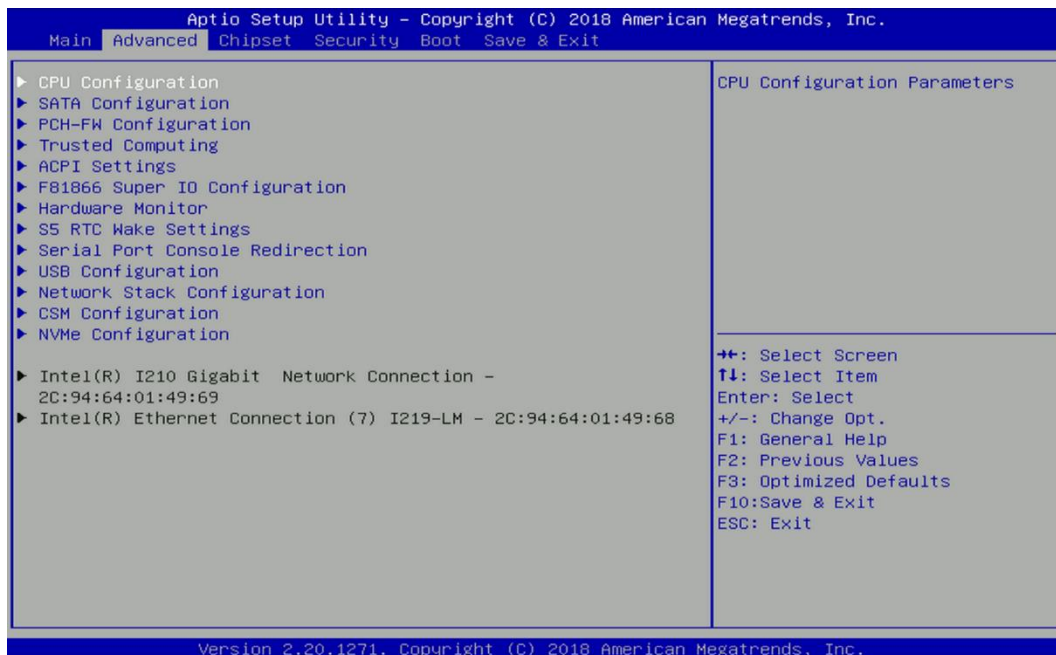

4.3.1 CPU Configuration

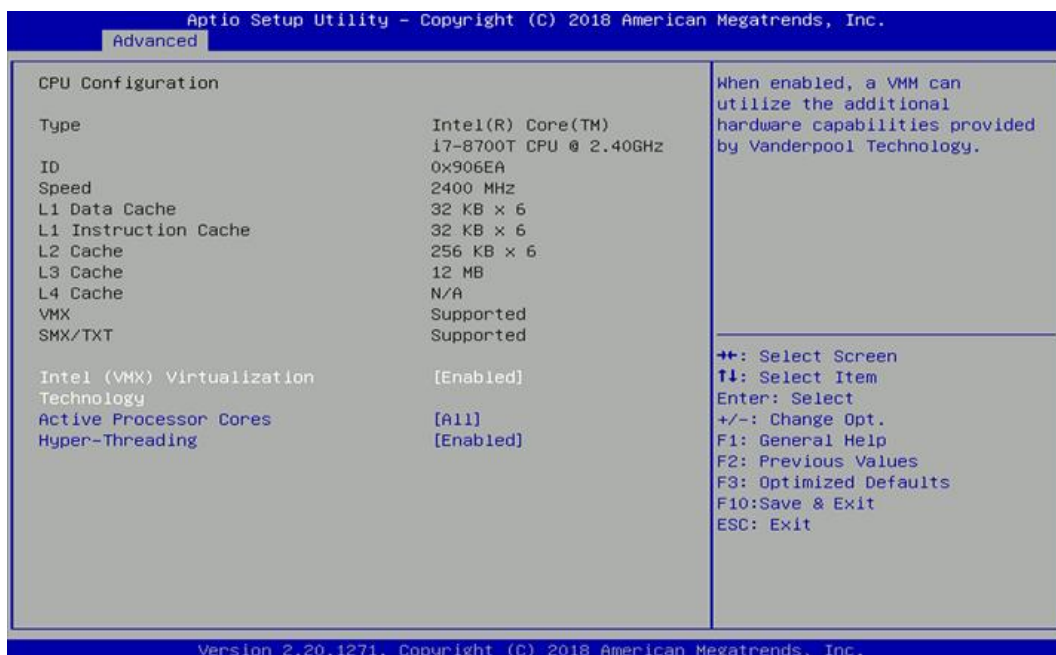

■ Intel (VMX) Virtualization Technology [Enabled]

Enables or disables Intel (VMX) Virtualization Technology. Virtualization enhanced by Intel Virtualization Technology will allow a platform to run multiple operating systems and applications in independent partitions. With virtualization, one computer system can function as multiple virtual systems.

■ Active Process Cores [All]

Allows you to choose the number of active processor cores.

Configuration options: [All] [1].

■ Hyper-threading

Enables or disables for Hyper-Threading Technology.

4.3.2 SATA Configuration

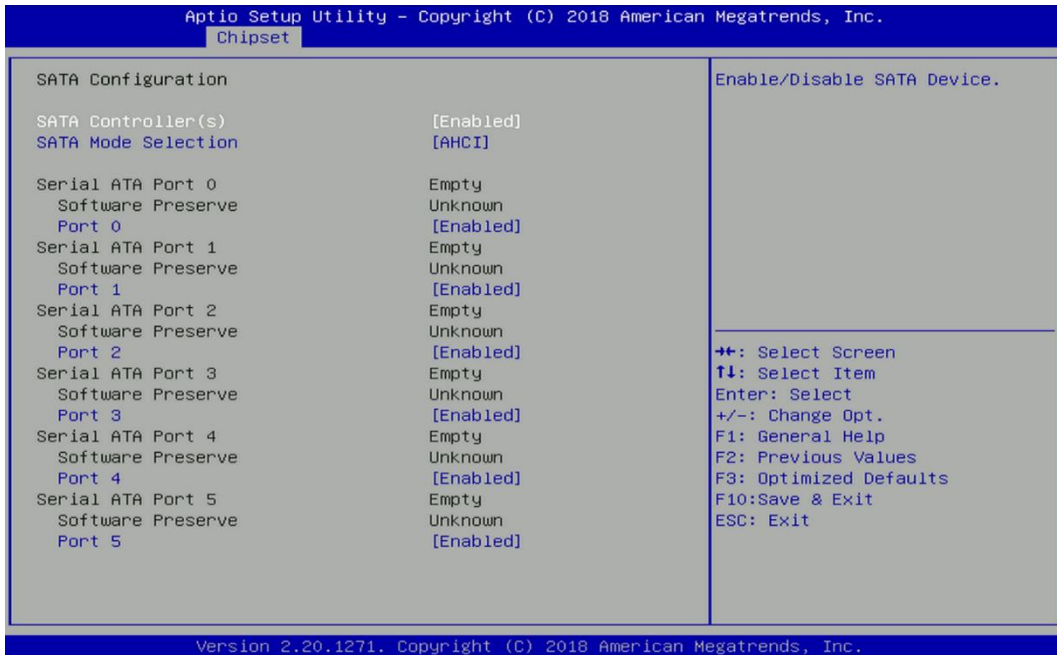

■ SATA Controller(s) [Enabled]

Enables or disables SATA device.

■ SATA Mode Selection [AHCI]

Allows you to select which mode SATA controller will operate.

Configuration options: [AHCI], [RAID]

■ Serial ATA Port 0

Port 0 [Enabled]

Enables or disables SATA Port 0.

■ Serial ATA Port 1

Port 1 [Enabled]

Enables or disables SATA Port 1.

■ Serial ATA Port 2

Port 2 [Enabled]

Enables or disables SATA Port 2.

■ Serial ATA Port 3

Port 3 [Enabled]

Enables or disables SATA Port 3.

■ Serial ATA Port 4

Port 4 [Enabled]

Enables or disables SATA Port 4.

■ Serial ATA Port 5

Port 5 [Enabled]

Enables or disables SATA Port 5.

4.3.3 PCH-FW Configuration

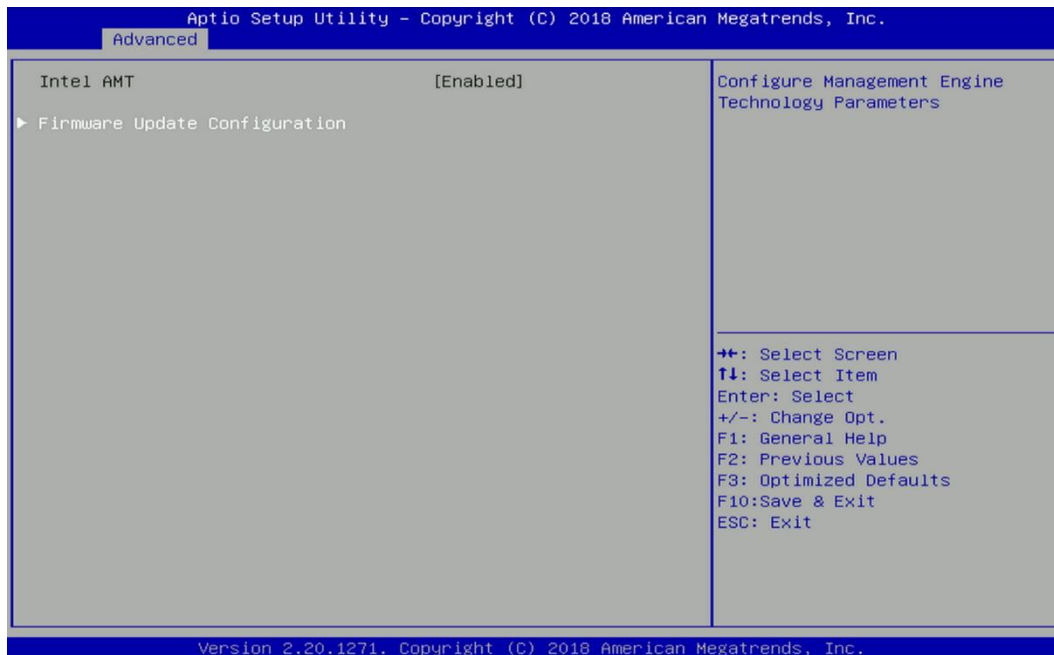

■ Firmware Update Configuration

Configure Management Engine Parameters

Me FW Image Re-Flash [Disabled]

Enables or disables Me FW Image Re-Flash function.

4.3.4 Trusted Computing

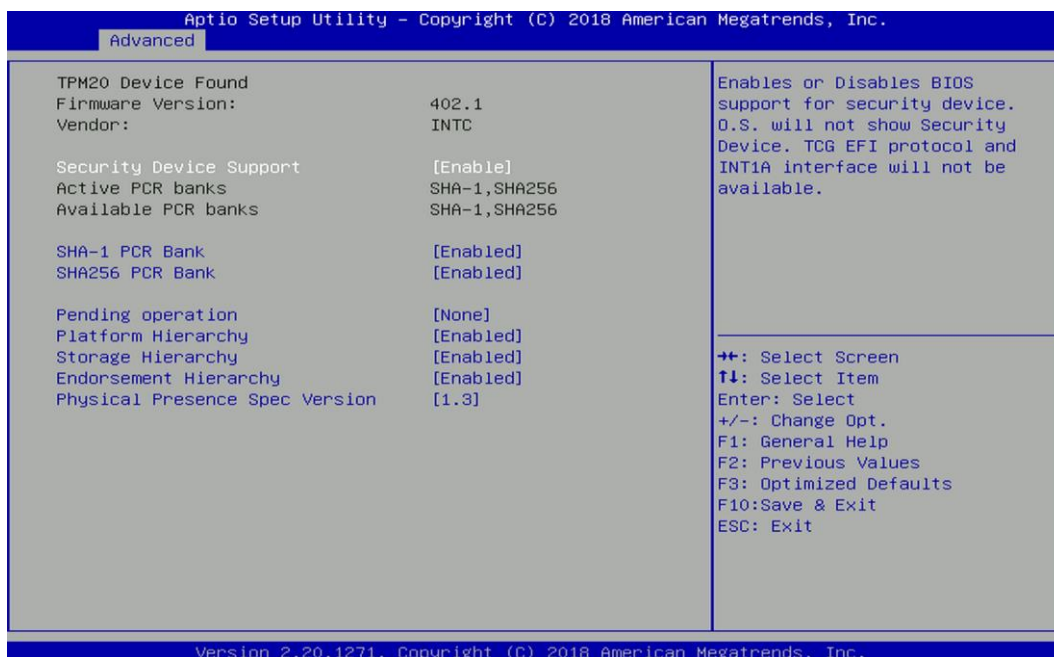

■ Security Device Support [Enabled]

Enables or disables BIOS support for security device.

■ SHA-1 PCR Bank [Enabled]

Enables or disables SHA-1 PCR (Platform Configuration Register) Bank.

■ SHA256 PCR Bank [Enabled]

Enables or disables SHA256 PCR (Platform Configuration Register) Bank.

■ Pending operation [None]

Schedule an Operation for the security device.

[None]: No operation.

[TPM Clear]: Clear TPM status.

■ **Platform Hierarchy [Enabled]**

Enables or disables platform hierarchy.

■ **Storage Hierarchy [Enabled]**

Enables or disables storage hierarchy.

■ **Endorsement Hierarchy [Enabled]**

Enables or disables endorsement hierarchy.

■ **Physical Presence Spec Version [1.3]**

Select the physical presence spec version.

Configuration options: [1.2] [1.3]

4.3.5 ACPI Settings

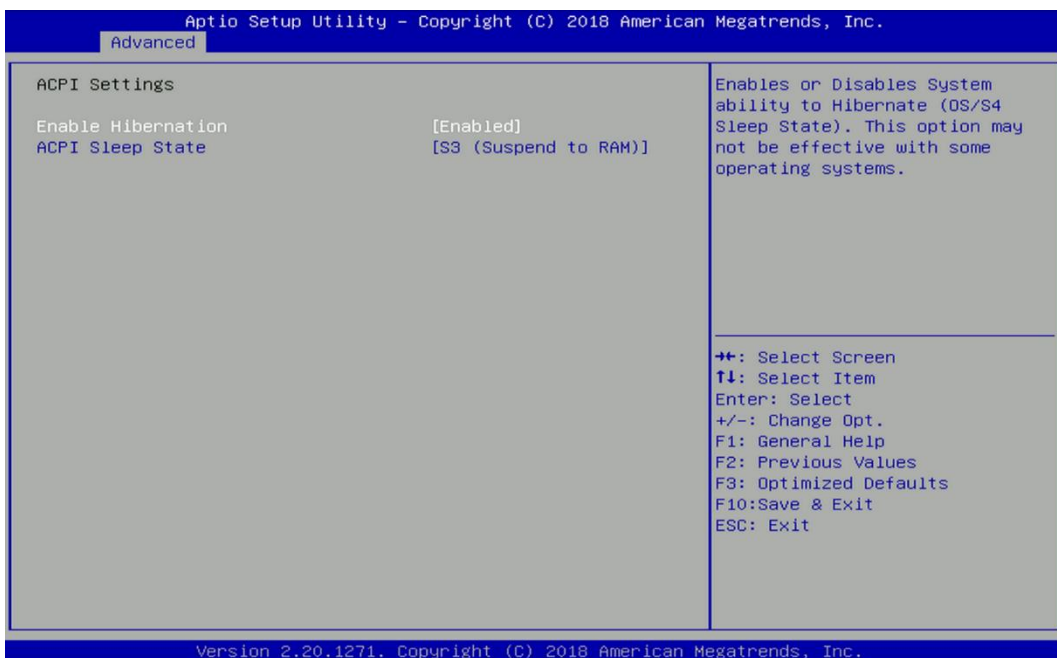

■ **Enable Hibernation [Enabled]**

Enables or disables system ability to hibernate state (OS/S4 state). This option may not be effective with some OS.

■ **ACPI Sleep State [S3 (Suspend to RAM)]**

Allows users to select the highest Advanced Configuration Power Interface® (ACPI) sleep state that system will enter when suspend button is pressed.

[Suspend Disabled]: Disables entering suspend state.

[S3 (suspend to RAM)]: Enables suspend to RAM state.

4.3.6 F81866 Super IO Configuration

Set Parameters of Serial Ports. User can Enable/Disable the serial port and Select an optimal setting for the Super IO Device.

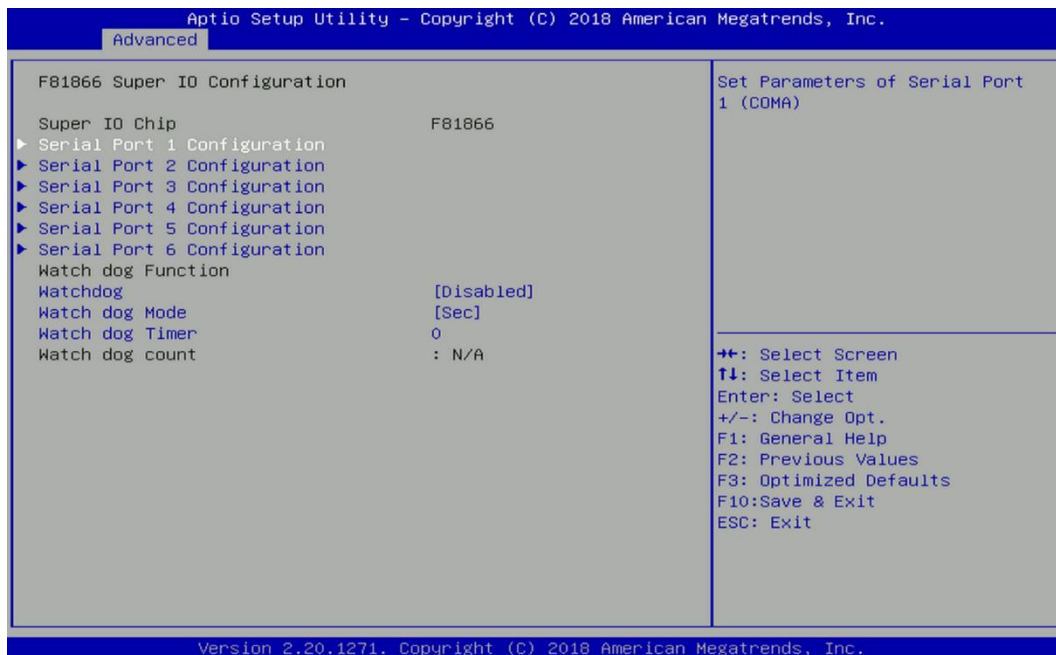

Serial Port 1~6 Configuration.

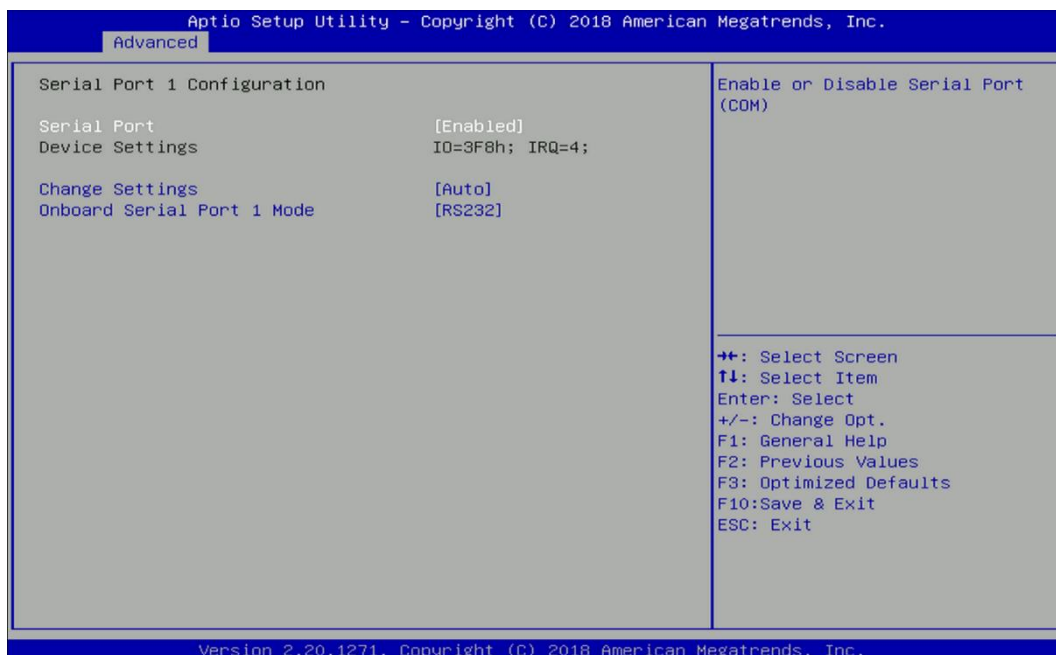

Serial Port [Enabled]

Enables or disables serial port.

Change Settings [Auto]

Allows you to change the IO Address & IRQ settings of the specified serial port.

Onboard Serial Port 1~6 Mode [RS232]

Allows you to select Serial Port Mode.

Configuration options: [RS232] [RS422/RS485 Full Duplex] [RS485 Half Duplex]

Watch Dog [Disabled]

Enables or disables watch dog function.

■ Watch Dog Mode [Sec]

Allows to set watchdog timer unit <Sec> or <Min>.

■ Watch Dog Timer [0]

Allows you to set watchdog timer's value in the range of 0 to 255.

4.3.7 Hardware Monitor

This screen displays the current status of all monitored hardware devices/components such as voltages, temperatures and all fans' speeds.

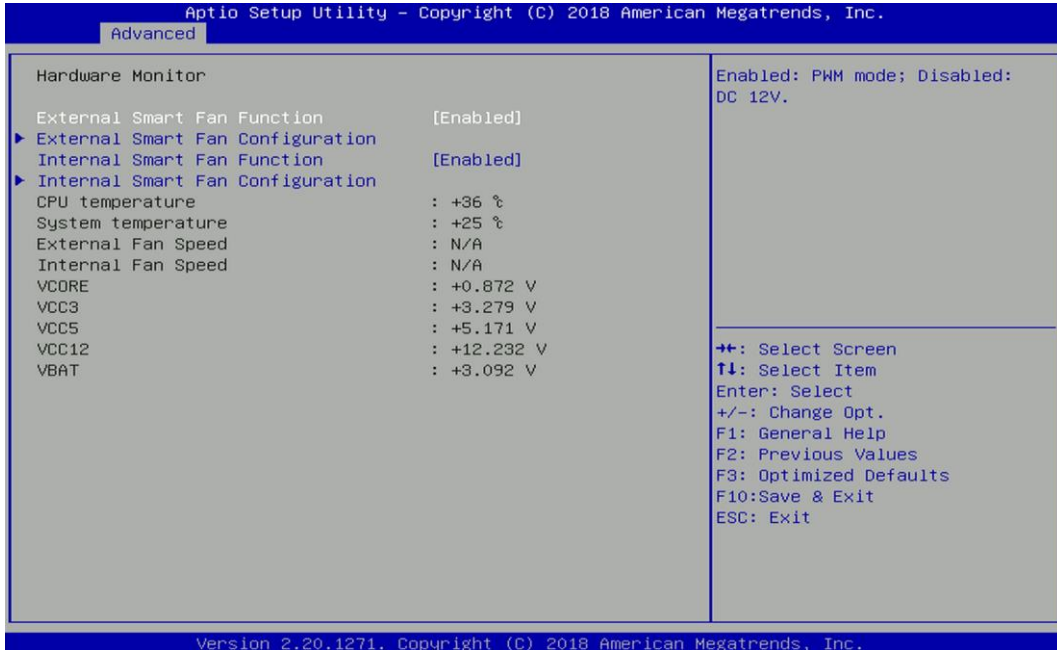

■ External Smart Fan Function [Enabled]

Enables or disables external smart fan function.

■ External Smart Fan Configuration

Allows users to setting external smart fan parameters.

■ Internal Smart Fan Function [Enabled]

Enables or disables internal smart fan function.

■ Internal Smart Fan Configuration

Allows users to setting internal smart fan parameters.

4.3.8 S5 RTC Wake Settings

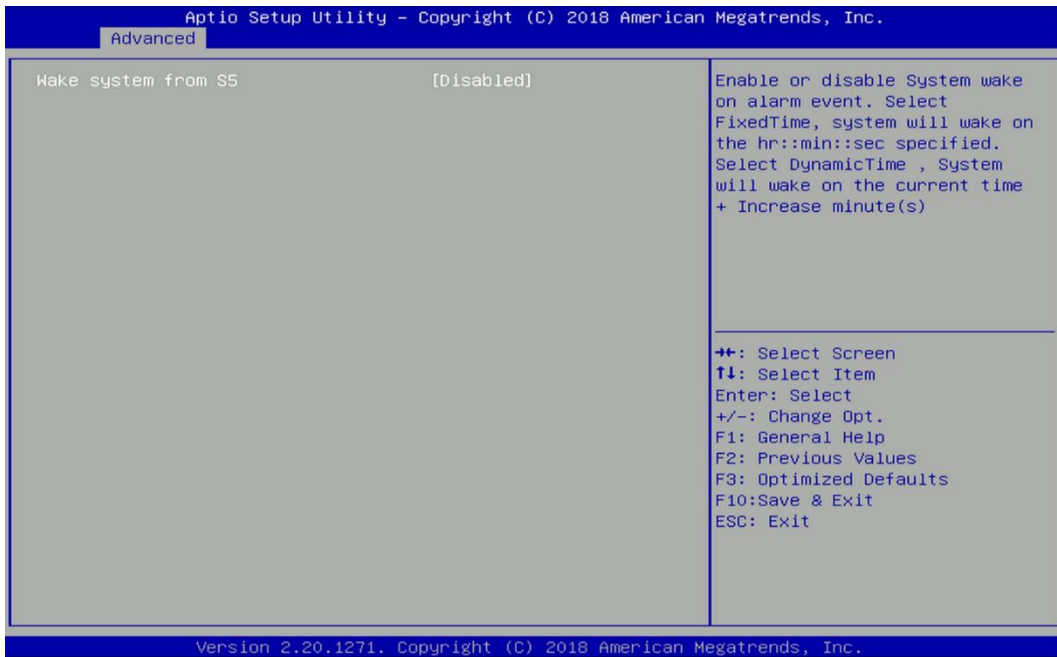

Wake system from S5 [Disabled]

Enables or disables wake system from S5 (soft-off state).

[Disabled]: Disables wake system from S5.

[Fixed Time]: Sets a fixed time (HH:MM:SS) to wake system from S5.

[Dynamic Time]: Sets an increase minute(s) from current time to wake system from S5.

4.3.9 Serial Port Console Redirection

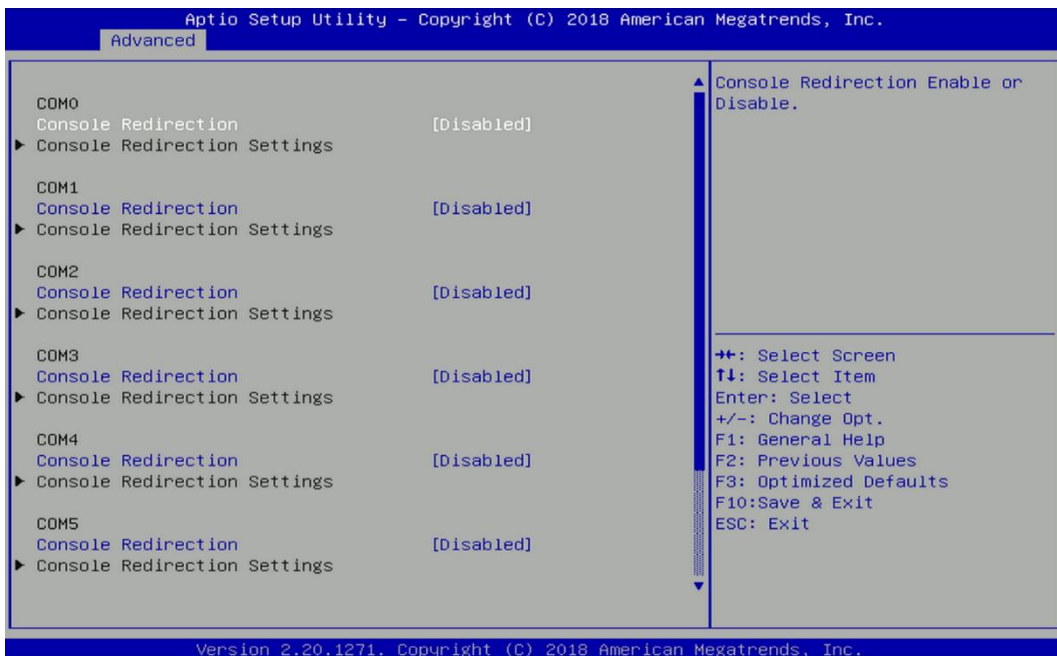

Console Redirection

Allow users to enable or disable COM0, COM1, COM2, COM3, COM4, COM5 console redirection function.

COM0 = Serial Port 1

COM1 = Serial Port 2

COM2 = Serial Port 3

COM3 = Serial Port 4

COM4 = Serial Port 5

COM5 = Serial Port 6

4.3.10 USB Configuration

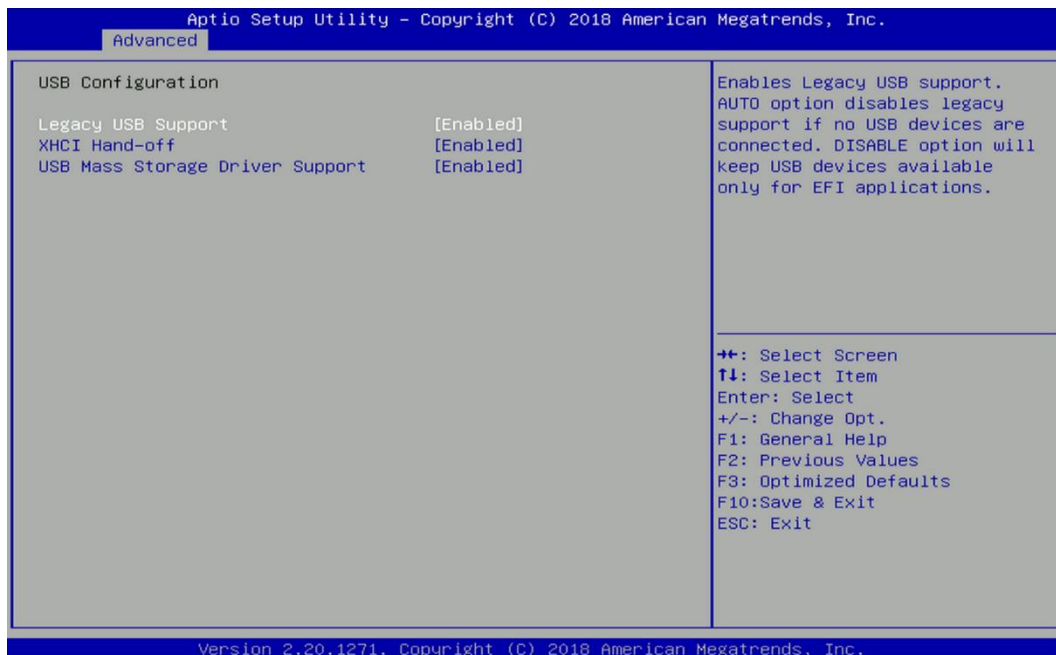

■ Legacy USB Support [Enabled]

This item allows users to enable or disable legacy USB support. When set to [Auto], legacy USB support will be disabled automatically if no USB devices are connected.

■ XHCI Hand-off [Enabled]

Enables or disables XHCI (USB3.0) hand-off function. Use this feature as a workaround for operating systems without XHCI hand-off support.

■ USB Mass Storage Driver Support [Enabled]

Enables or disables USB mass storage driver support.

4.3.11 Network Stack Configuration

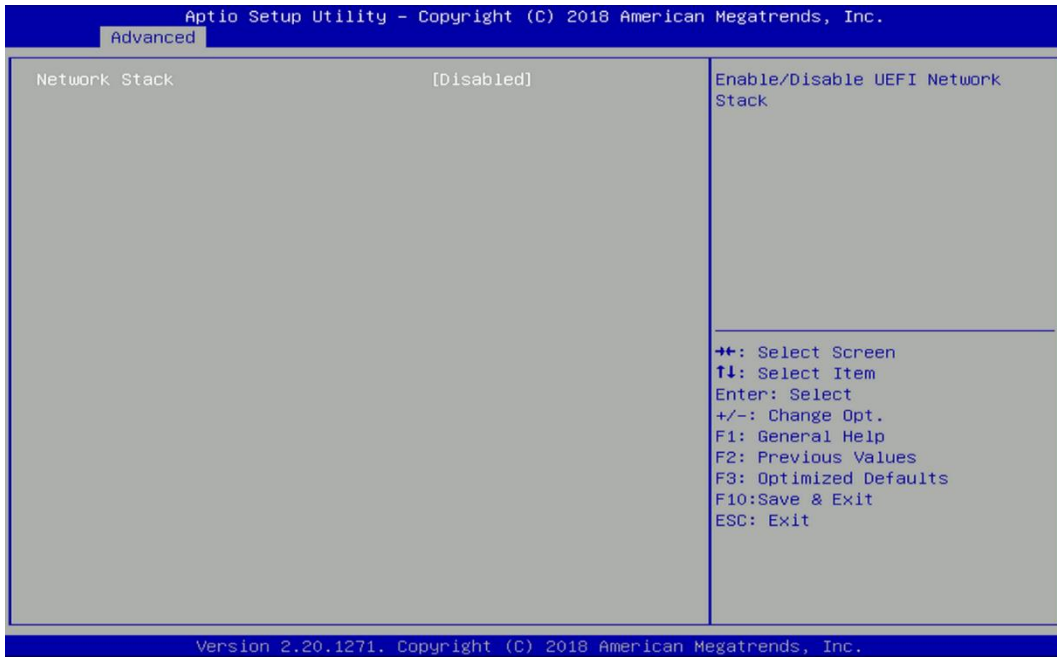

■ Network Stack [Disabled]

Enables or disables UEFI Network Stack.

4.3.12 CSM Configuration

This option controls legacy/UEFI ROMs priority.

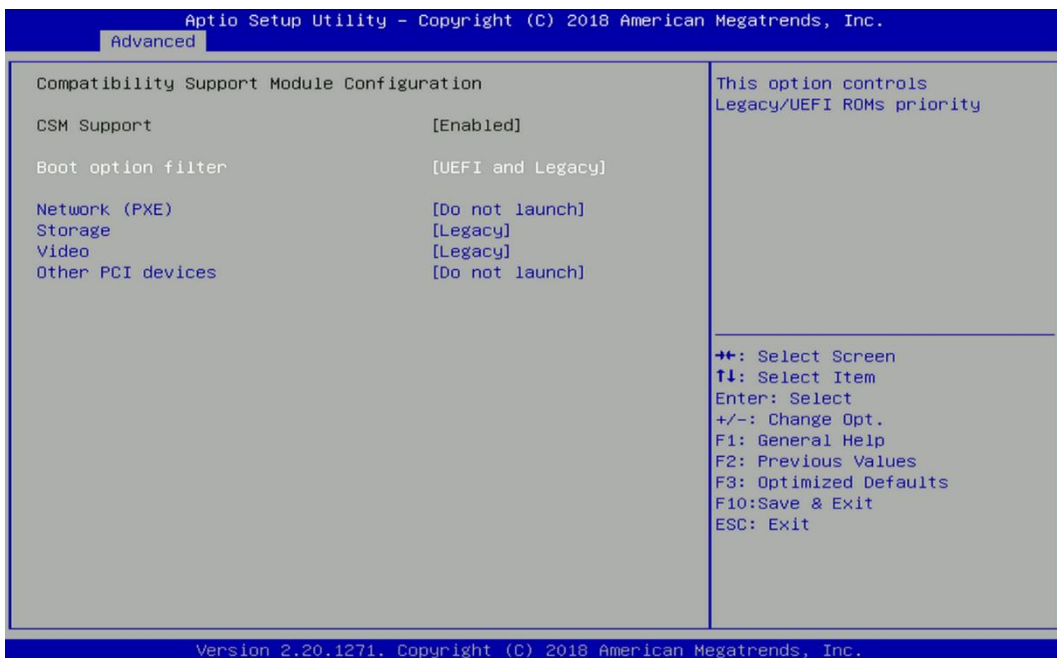

■ Boot option filter [UEFI and Legacy]

Allows you to select which type of operating system to boot.

[UEFI and Legacy]: Allows booting from operating systems that support legacy option ROM or UEFI option ROM.

[Legacy only]: Allows booting from operating systems that only support legacy option ROM.

[UEFI only]: Allows booting from operating systems that only support UEFI option ROM.

■ Network PXE [Do not launch]

Controls the execution of UEFI and Legacy PXE (Network Preboot eXecution Environment) option ROM.

[Do not launch]: Disables option ROM execution.

[Legacy]: Enables legacy option ROM only.

■ Storage [Legacy]

Controls the execution of UEFI and Legacy Storage option ROM.

[Do not launch]: Disables option ROM execution.

[UEFI]: Enables UEFI option ROM only.

[Legacy]: Enables legacy option ROM only.

■ Video [Legacy]

Controls the execution of UEFI and Legacy Video option ROM.

[Do not launch]: Disables option ROM execution.

[UEFI]: Enables UEFI option ROM only.

[Legacy]: Enables legacy option ROM only.

■ Other PCI devices [Do not launch]

Allows users to determine option ROM execution policy for device other than network, storage, or video.

4.3.13 NVMe Configuration

This screen displays the current NVMe device information.

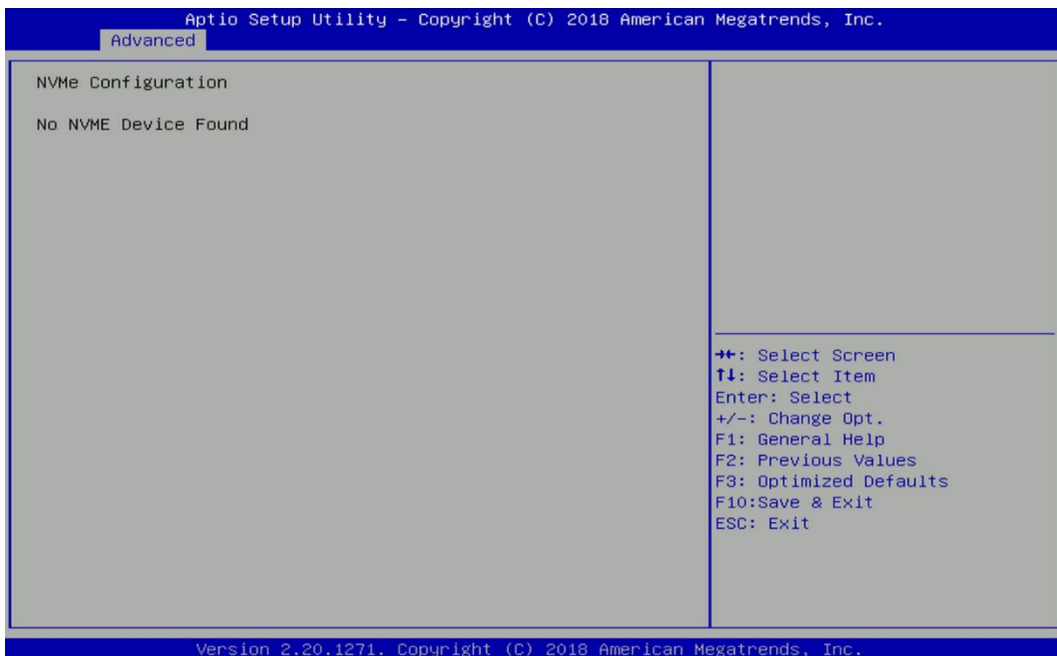

4.4 Chipset Setup

This section allows you to configure chipset related settings according to user's preference.

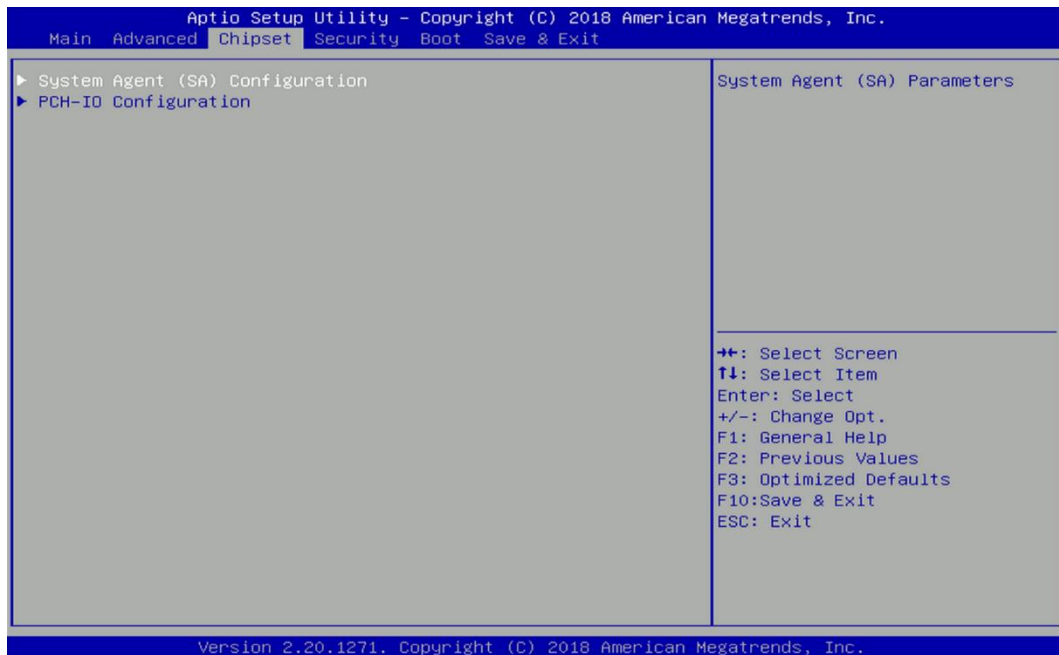

4.4.1 System Agent (SA) Configuration

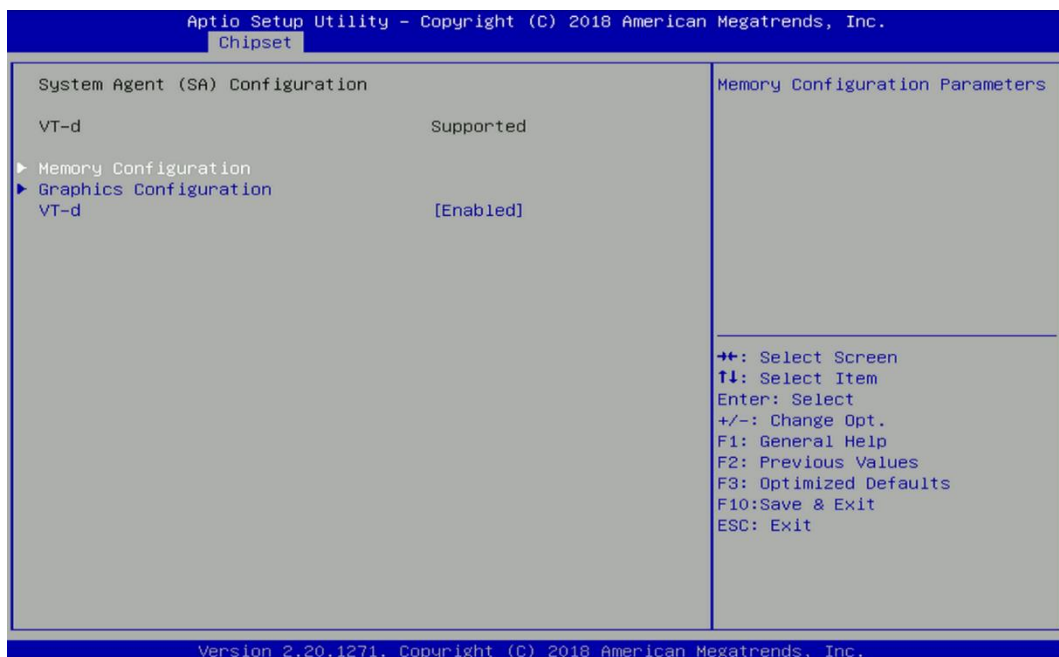

■ Memory Configuration

This item displays detailed memory configuration in the system.

Max TOLUD [Dynamic]

This feature sets the maximum TOLUD (Top of Low Usable DRAM) value, which specifies the TOLUD memory space to be used by internal graphics devices, GTT Stolen Memory, and TSEG, respectively, if these devices are enabled.

Configuration options: [Dynamic] [1 GB] [1.25 GB] [1.5 GB] [1.75 GB] [2 GB] [2.25 GB] [2.5 GB] [2.75 GB] [3 GB]

■ Graphics Configuration

❑ Primary Display [Auto]

Allows users to select which graphics device should be primary display or select SG for switchable graphics.

Configuration options: [Auto] [IGFX] [PEG] [PCIe]

❑ Internal Graphics [Auto]

Allows users to enable or disable Internal Graphics.

Configuration options: [Auto] [Disabled] [Enabled]

■ VT-d [Enabled]

Enables or disables Intel® Virtualization Technology for Directed I/O (VT-d) capability.

4.4.2 PCH-IO Configuration

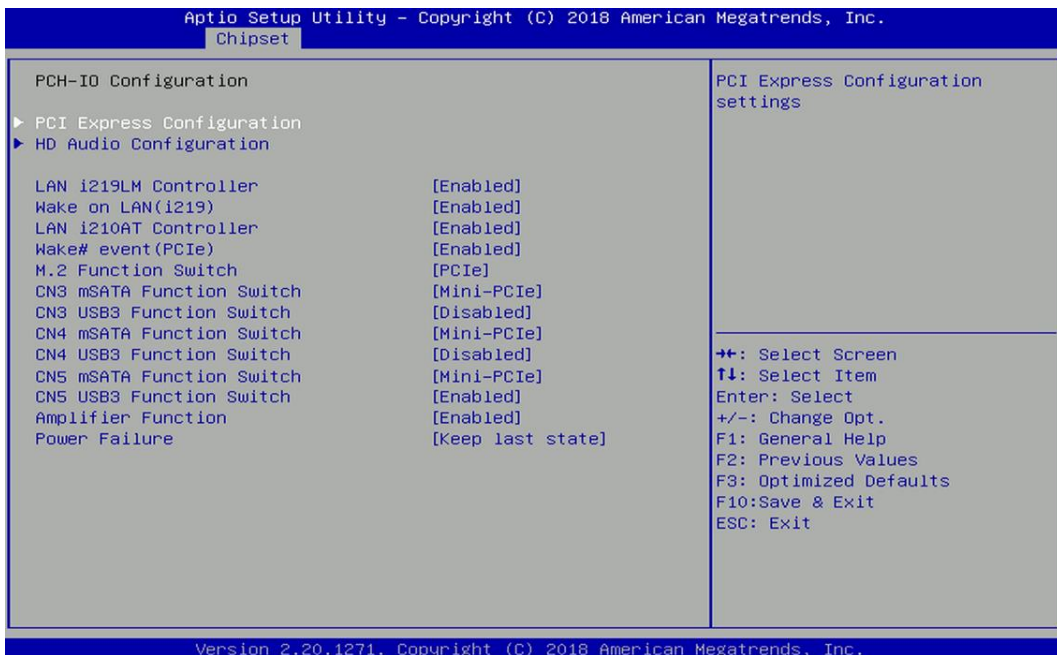

■ PCI Express Configuration

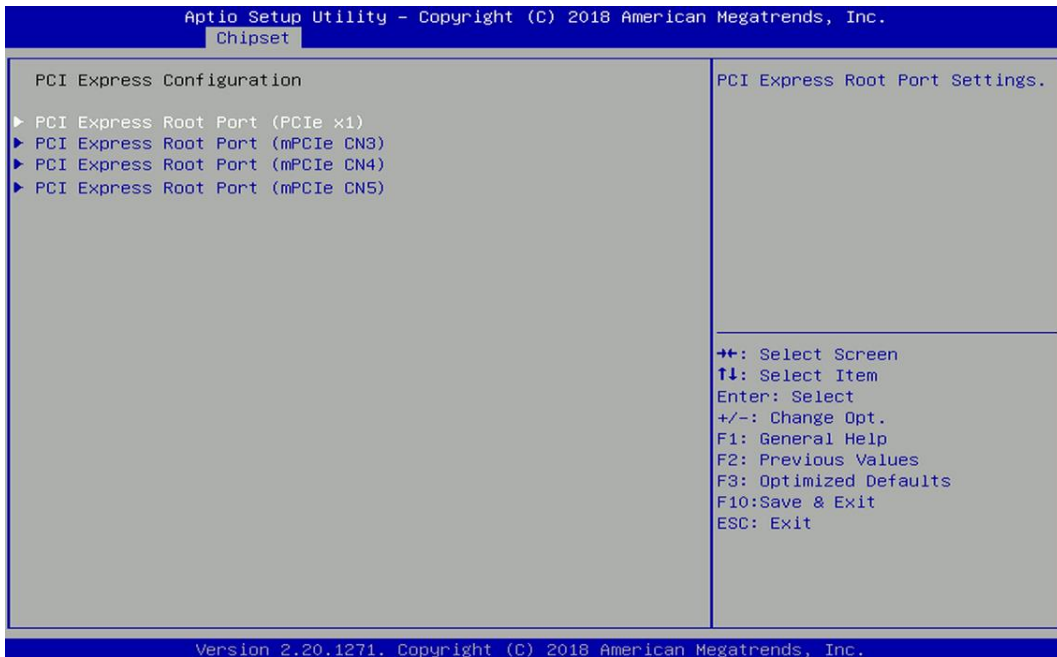

PCI Express Root Port (PCIe x1)

- PCI Express Root Port 1 [Enabled]**
Enables or disables PCI Express Root Port 1.
- PCleSpeed [Auto]**
Allows you to select PCI Express port speed.
Configuration options: [Auto] [Gen1] [Gen2] [Gen3].

PCI Express Root Port (mPCIe CN3)

- PCI Express Root Port 1 [Enabled]**
Enables or disables PCI Express Root Port 1.
- PCleSpeed [Auto]**
Allows you to select PCI Express port speed.
Configuration options: [Auto] [Gen1] [Gen2] [Gen3].

PCI Express Root Port (mPCIe CN4)

- PCI Express Root Port 1 [Enabled]**
Enables or disables PCI Express Root Port 1.
- PCleSpeed [Auto]**
Allows you to select PCI Express port speed.
Configuration options: [Auto] [Gen1] [Gen2] [Gen3].

PCI Express Root Port (mPCIe CN5)

- PCI Express Root Port 1 [Enabled]**
Enables or disables PCI Express Root Port 1.
- PCleSpeed [Auto]**
Allows you to select PCI Express port speed.
Configuration options: [Auto] [Gen1] [Gen2] [Gen3].

■ LAN i219LM Controller [Enabled]

Enables or disables I219LM LAN Controller.

■ Wake on LAN (i219) [Enabled]

Enables or disables integrated LAN i219LM Wake On LAN function.

■ **LAN i210AT Controller [Enabled]**

Enables or disables I210 LAN Controller.

■ **Wake# event (PCIe) [Enabled]**

Enables or disables integrated LAN I210 Wake On LAN function.

■ **M.2 function Switch [PCIe]**

Select PCIe/SATA for M.2 connector.

■ **CN3 mSATA Function Switch [Mini-PCIe]**

Allows you to change **Mini PCIe1 (CN3)** as [Mini-PCIe] or [mSATA].

■ **CN3 USB3 Function Switch [Disabled]**

Enables or disables CN3 USB3 Controller.

■ **CN4 mSATA Function Switch [Mini-PCIe]**

Allows you to change **Mini PCIe1 (CN4)** as [Mini-PCIe] or [mSATA].

■ **CN4 USB3 Function Switch [Disabled]**

Enables or disables CN4 USB3 Controller.

■ **CN5 mSATA Function Switch [Mini-PCIe]**

Allows you to change **Mini PCIe1 (CN5)** as [Mini-PCIe] or [mSATA].

■ **CN5 USB3 Function Switch [Disabled]**

Enables or disables CN5 USB3 Controller.

■ **Amplifier Function [Enabled]**

Enables or disables Amplifier Function.

■ **Power Failure [Keep last state]**

Allows you to specify which power state system will enter when power is resumed after a power failure (G3 state).

[Always on]: Enters to power on state.

[Always off]: Enters to power off state.

[Keep last state]: Enters to the last power state before a power failure.

4.5 Security Setup

This section allows users to configure BIOS security settings.

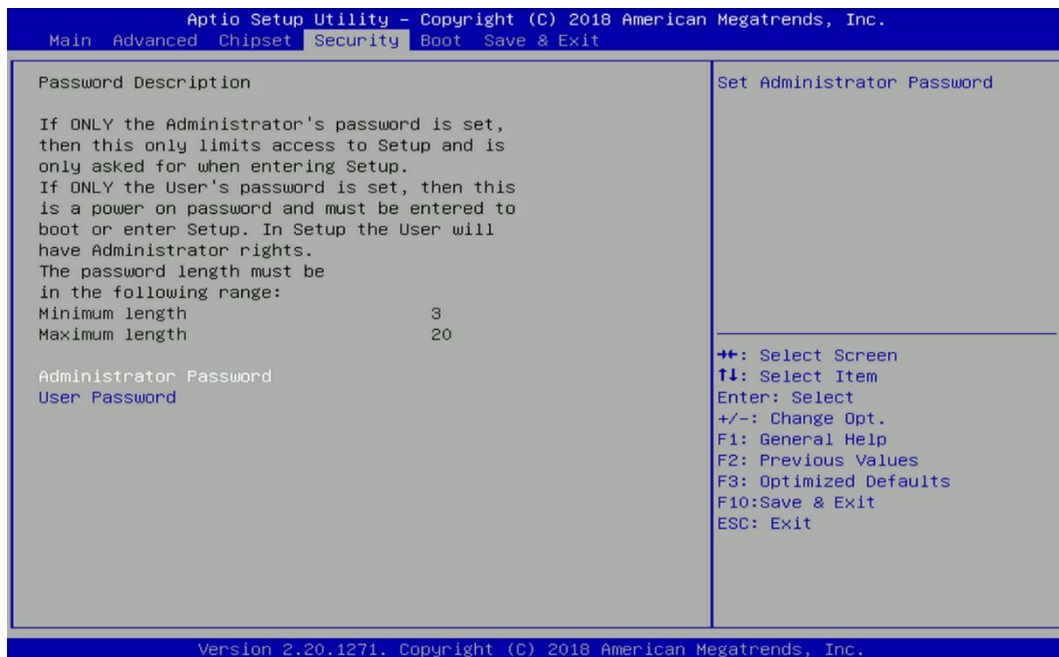

4.5.1 Administrator Password

Administrator Password controls access to the BIOS Setup utility.

4.5.2 User Password

User Password controls access to the system at boot and to the BIOS Setup utility.

4.6 Boot Setup

This section allows you to configure Boot settings.

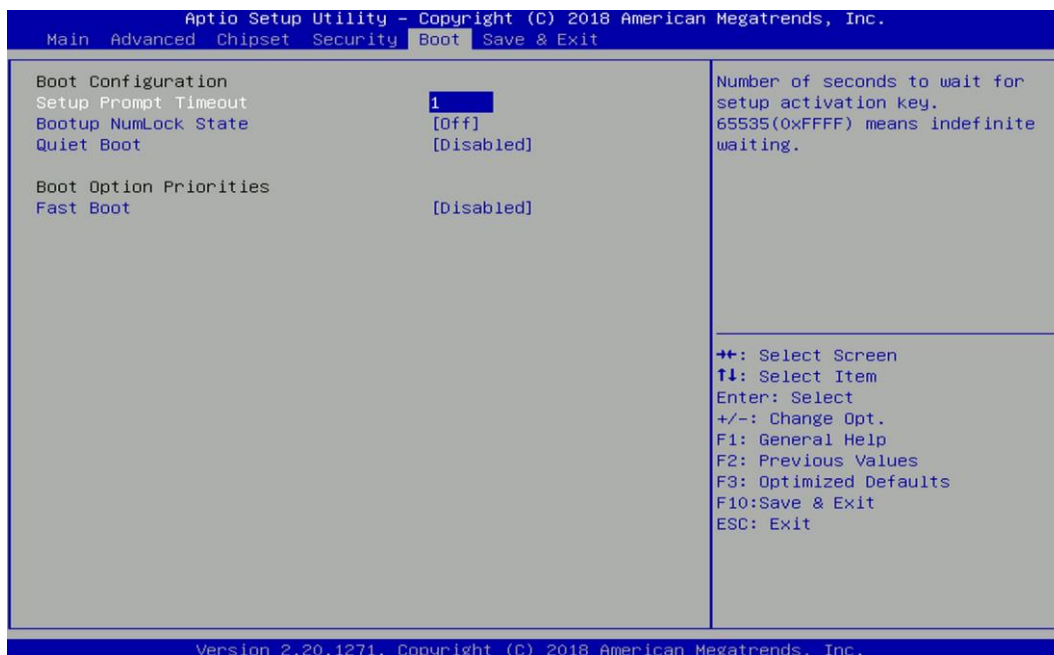

■ Setup Prompt Timeout [1]

Use this item to set number of seconds (1..65535) to wait for setup activation key.

■ Bootup NumLock State

Allows you to set NumLock key to [On] or [Off] state when system boots up.

■ Quiet Boot

Allows you to enable or disable Quiet Boot function.

■ Fast Boot

Allows you to enable or disable Fast Boot function. If enabled, system boots with initialization of a minimal set of devices required to launch active boot option.

■ Hard Drive BBS Priority

Allows you to set the order of the legacy devices in this group.

4.7 Save & Exit

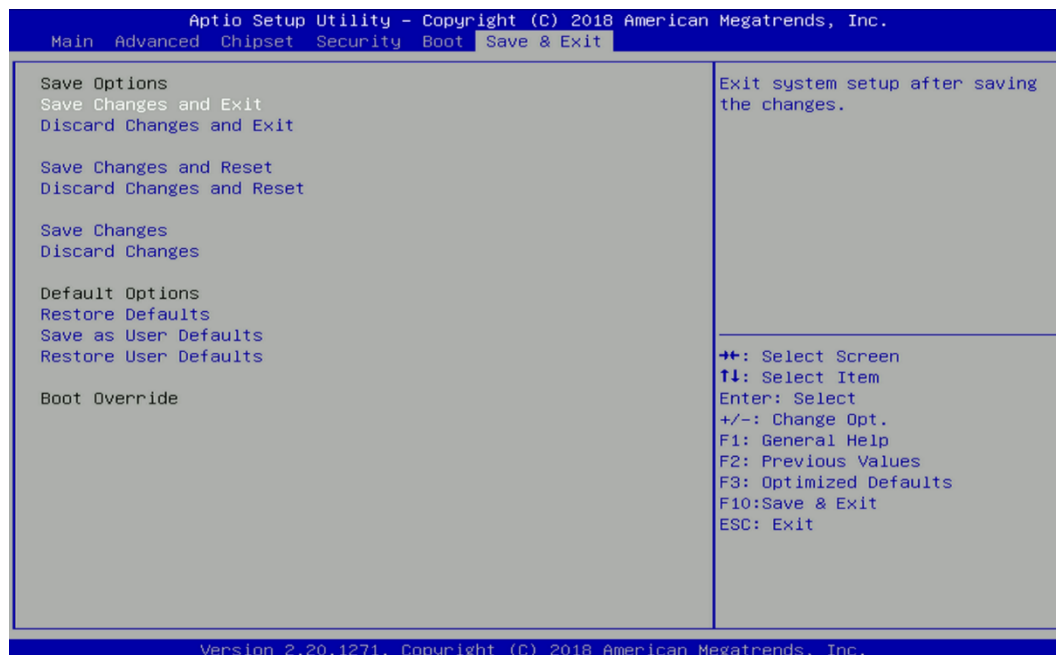

■ Save Changes and Exit

This item allows you to exit the system after saving changes.

■ Discard Changes and Exit

This item allows you to reset the system setup without saving any changes.

■ Save Changes and Reset

This item allows you to reset the system after saving changes.

■ Discard Changes and Reset

This item allows you to reset the system setup without saving any changes.

■ Save Changes

This item allows you to save changes done so far to any of the setup options.

■ Discard Changes

This item allows you to discard changes done so far to any of the setup options.

■ Restore Defaults

This item allows you to restore/ load default values for all the setup options.

■ Save as User Defaults

This item allows you to save the changes done so far as user defaults.

■ Restore User Defaults

This item allows you to restore the user defaults to all the setup options.



Chapter 5

Product Application

(For DIO only)

5.1 Digital I/O (DIO) application

This section describes DIO application of the product. The content and application development are better understood and implemented by well experienced professionals or developers.

5.1.1 Digital I/O Programming Guide

5.1.1.1 Pins for Digital I/O 1~8

Item	Standard	Item	Standard
GPIO70 (PIN 103)	DI	GPIO80 (PIN 111)	DO
GPIO71 (PIN 104)		GPIO81 (PIN 112)	
GPIO72 (PIN 105)		GPIO82 (PIN 113)	
GPIO73 (PIN 106)		GPIO83 (PIN 114)	
GPIO74 (PIN 107)		GPIO84 (PIN 115)	
GPIO75 (PIN 108)		GPIO85 (PIN 116)	
GPIO76 (PIN 109)		GPIO86 (PIN 117)	
GPIO77 (PIN 110)		GPIO87 (PIN 118)	

5.1.1.2 Pins for Digital I/O 9-16

Item	Standard	Item	Standard
GPIO30 (PIN 36)	DI	GPIO40 (PIN 44)	DO
GPIO31 (PIN 37)		GPIO41 (PIN 45)	
GPIO32 (PIN 38)		GPIO42 (PIN 46)	
GPIO33 (PIN 39)		GPIO43 (PIN 47)	
GPIO34 (PIN 40)		GPIO44 (PIN 48)	
GPIO35 (PIN 41)		GPIO45 (PIN 49)	
GPIO36 (PIN 42)		GPIO46 (PIN 50)	
GPIO37 (PIN 43)		GPIO47 (PIN 51)	

5.1.1.3 Programming Guide

To program the Super I/O chip F81866A configuration registers, the following configuration procedures must be followed in sequence:

- (1) Enter the Extended Function Mode
- (2) Configure the configuration registers
- (3) Exit the Extended Function Mode

The configuration register is used to control the behavior of the corresponding devices. To configure the register, use the index port to select the index and then write data port to alter the parameters. The default index port and data port are 0x4E and 0x4F, respectively.

Pull down the SOUT1 pin to change the default value to 0x2E/ 0x2F. To enable configuration, the entry key 0x87 must be written to the index port. To disable configuration, write exit entry key 0xAA to the index port.

Following is an example to enable configuration and to disable configuration by using debug.

- o 4e 87
- o 4e 87 (enable configuration)
- o 4e aa (disable configuration)

5.1.1.4 Relative Registers

To program the F81866A configuration registers, see the following configuration procedures.

Logic Device Number Register (LDN) — Index 07h

Bit	Name	R/W	Reset	Default	Description
7-0	LDN	R/W	LRESET#	00h	00h: Select FDC device configuration registers. 03h: Select Parallel Port device configuration registers. 04h: Select Hardware Monitor device configuration registers. 05h: Select KBC device configuration registers. 06h: Select GPIO device configuration registers. 07h: Select WDT device configuration registers. 0Ah: Select PME, ACPI and ERP device configuration registers. 10h: Select UART1 device configuration registers. 11h: Select UART2 device configuration registers. 12h: Select UART3 device configuration registers. 13h: Select UART4 device configuration registers. 14h: Select UART5 device configuration registers. 15h: Select UART6 device configuration registers. Otherwise: Reserved.

8.7.13.1 GPIO7 Output Enable Register — Index 80h

Bit	Name	R/W	Reset	Default	Description
7	GPIO77_OE	R/W	LRESET#	0	0: GPIO77 is in input mode. 1: GPIO77 is in output mode.
6	GPIO76_OE	R/W	LRESET#	0	0: GPIO76 is in input mode. 1: GPIO76 is in output mode.
5	GPIO75_OE	R/W	LRESET#	0	0: GPIO75 is in input mode. 1: GPIO75 is in output mode.
4	GPIO74_OE	R/W	LRESET#	0	0: GPIO74 is in input mode. 1: GPIO74 is in output mode.
3	GPIO73_OE	R/W	LRESET#	0	0: GPIO73 is in input mode. 1: GPIO73 is in output mode.
2	GPIO72_OE	R/W	LRESET#	0	0: GPIO72 is in input mode. 1: GPIO72 is in output mode.
1	GPIO71_OE	R/W	LRESET#	0	0: GPIO71 is in input mode. 1: GPIO71 is in output mode.
0	GPIO70_OE	R/W	LRESET#	0	0: GPIO70 is in input mode. 1: GPIO70 is in output mode.

8.7.13.3 GPIO7 Pin Status Register — Index 82h (This byte could be also read by base address + 3)

Bit	Name	R/W	Reset	Default	Description
7	GPIO77_IN	R	-	-	The pin status of GPIO77/STB#.
6	GPIO76_IN	R	-	-	The pin status of GPIO76/AFD#.
5	GPIO75_IN	R	-	-	The pin status of GPIO75/ERR#.
4	GPIO74_IN	R	-	-	The pin status of GPIO74/INIT#.
3	GPIO73_IN	R	-	-	The pin status of GPIO73/SLIN#.
2	GPIO72_IN	R	-	-	The pin status of GPIO72/ACK#.
1	GPIO71_IN	R	-	-	The pin status of GPIO71/BUSY.
0	GPIO70_IN	R	-	-	The pin status of GPIO70/PE/FANCTL3/PWM_DAC3.

8.7.9.1 GPIO3 Output Enable Register — Index C0h

Bit	Name	R/W	Reset	Default	Description
7	GPIO37_OE	R/W	LRESET#	0	0: GPIO37 is input. 1: GPIO37 is output.
6	GPIO36_OE	R/W	LRESET#	0	0: GPIO36 is input. 1: GPIO36 is output.
5	GPIO35_OE	R/W	LRESET#	0	0: GPIO35 is input. 1: GPIO35 is output.
4	GPIO34_OE	R/W	LRESET#	0	0: GPIO34 is input. 1: GPIO34 is output.
3	GPIO33_OE	R/W	LRESET#	0	0: GPIO33 is input. 1: GPIO33 is output.
2	GPIO32_OE	R/W	LRESET#	0	0: GPIO32 is input. 1: GPIO32 is output.
1	GPIO31_OE	R/W	LRESET#	0	0: GPIO31 is input. 1: GPIO31 is output.
0	GPIO30_OE	R/W	LRESET#	0	0: GPIO30 is input. 1: GPIO30 is output.

8.7.9.3 GPIO3 Pin Status Register — Index C2h (This byte could be also read by base address + 9 if GPIO_DEC_RANGE is set to "1")

Bit	Name	R/W	Reset	Default	Description
7	GPIO37_IN	R	-	-	The pin status of SIN3/GPIO37.
6	GPIO36_IN	R	-	-	The pin status of SOUT3/GPIO36.
5	GPIO35_IN	R	-	-	The pin status of DSR3#/GPIO35.
4	GPIO34_IN	R	-	-	The pin status of RTS3#/GPIO34.
3	GPIO33_IN	R	-	-	The pin status of DTR3#/GPIO33.
2	GPIO32_IN	R	-	-	The pin status of CTS3#/GPIO32.
1	GPIO31_IN	R	-	-	The pin status of RI3#/GPIO31.
0	GPIO30_IN	R	-	-	The pin status of DCD3#/GPIO30.

8.7.14.1 GPIO8 Output Enable Register — Index 88h

Bit	Name	R/W	Reset	Default	Description
7	GPIO87_OE	R/W	LRESET#	1	0: GPIO87 is in input mode. 1: GPIO87 is in output mode.
6	GPIO86_OE	R/W	LRESET#	1	0: GPIO86 is in input mode. 1: GPIO85 is in output mode.
5	GPIO85_OE	R/W	LRESET#	1	0: GPIO85 is in input mode. 1: GPIO85 is in output mode.
4	GPIO84_OE	R/W	LRESET#	1	0: GPIO84 is in input mode. 1: GPIO84 is in output mode.
3	GPIO83_OE	R/W	LRESET#	1	0: GPIO83 is in input mode. 1: GPIO83 is in output mode.
2	GPIO82_OE	R/W	LRESET#	1	0: GPIO82 is in input mode. 1: GPIO82 is in output mode.
1	GPIO81_OE	R/W	LRESET#	1	0: GPIO81 is in input mode. 1: GPIO81 is in output mode.
0	GPIO80_OE	R/W	LRESET#	1	0: GPIO80 is in input mode. 1: GPIO80 is in output mode.

8.7.14.2 GPIO8 Output Data Register — Index 89h (This byte could be also written by base address + 2)

Bit	Name	R/W	Reset	Default	Description
7	GPIO87_VAL	R/W	LRESET#	1	0: GPIO87 outputs 0 when in output mode. 1: GPIO87 outputs 1 when in output mode.
6	GPIO86_VAL	R/W	LRESET#	1	0: GPIO86 outputs 0 when in output mode. 1: GPIO86 outputs 1 when in output mode.
5	GPIO85_VAL	R/W	LRESET#	1	0: GPIO85 outputs 0 when in output mode. 1: GPIO85 outputs 1 when in output mode.
4	GPIO84_VAL	R/W	LRESET#	1	0: GPIO84 outputs 0 when in output mode. 1: GPIO84 outputs 1 when in output mode.
3	GPIO83_VAL	R/W	LRESET#	1	0: GPIO83 outputs 0 when in output mode. 1: GPIO83 outputs 1 when in output mode.
2	GPIO82_VAL	R/W	LRESET#	1	0: GPIO82 outputs 0 when in output mode. 1: GPIO82 outputs 1 when in output mode.
1	GPIO81_VAL	R/W	LRESET#	1	0: GPIO81 outputs 0 when in output mode. 1: GPIO81 outputs 1 when in output mode.
0	GPIO80_VAL	R/W	LRESET#	1	0: GPIO80 outputs 0 when in output mode. 1: GPIO80 outputs 1 when in output mode.

8.7.10.1 GPIO4 Output Enable Register — Index B0h

Bit	Name	R/W	Reset	Default	Description
7	GPIO47_OE	R/W	LRESET#	1	0: GPIO47 is input. 1: GPIO47 is output.
6	GPIO46_OE	R/W	LRESET#	1	0: GPIO46 is input. 1: GPIO46 is output.
5	GPIO45_OE	R/W	LRESET#	1	0: GPIO45 is input. 1: GPIO45 is output.
4	GPIO44_OE	R/W	LRESET#	1	0: GPIO44 is input. 1: GPIO44 is output.
3	GPIO43_OE	R/W	LRESET#	1	0: GPIO43 is input. 1: GPIO43 is output.
2	GPIO42_OE	R/W	LRESET#	1	0: GPIO42 is input. 1: GPIO42 is output.
1	GPIO41_OE	R/W	LRESET#	1	0: GPIO41 is input. 1: GPIO41 is output.
0	GPIO40_OE	R/W	LRESET#	1	0: GPIO40 is input. 1: GPIO40 is output.

8.7.10.2 GPIO4 Output Data Register — Index B1h (This byte could be also written by base address + 10 if GPIO_DEC_RANGE is set to “1”)

Bit	Name	R/W	Reset	Default	Description
7	GPIO47_DATA	R/W	LRESET#	1	0: GPIO47 outputs 0 when in output mode. 1: GPIO47 outputs 1 when in output mode.
6	GPIO46_DATA	R/W	LRESET#	1	0: GPIO46 outputs 0 when in output mode. 1: GPIO46 outputs 1 when in output mode.
5	GPIO45_DATA	R/W	LRESET#	1	0: GPIO45 outputs 0 when in output mode. 1: GPIO45 outputs 1 when in output mode.
4	GPIO44_DATA	R/W	LRESET#	1	0: GPIO44 outputs 0 when in output mode. 1: GPIO44 outputs 1 when in output mode.
3	GPIO43_DATA	R/W	LRESET#	1	0: GPIO43 outputs 0 when in output mode. 1: GPIO43 outputs 1 when in output mode.
2	GPIO42_DATA	R/W	LRESET#	1	0: GPIO42 outputs 0 when in output mode. 1: GPIO42 outputs 1 when in output mode.
1	GPIO41_DATA	R/W	LRESET#	1	0: GPIO41 outputs 0 when in output mode. 1: GPIO41 outputs 1 when in output mode.
0	GPIO40_DATA	R/W	LRESET#	1	0: GPIO40 outputs 0 when in output mode. 1: GPIO40 outputs 1 when in output mode.

8.7.3 Base Address High Register — Index 60h

Bit	Name	R/W	Reset	Default	Description
7-0	GP_BASE_ADDR_HI	R/W	LRESET#	00h	The MSB of GPIO I/O port address.

8.7.3.4 Base Address Low Register — Index 61h

Bit	Name	R/W	Reset	Default	Description
7-0	BASE_ADDR_LO	R/W	LRESET#	00h	<p>The LSB of KBC data port address. When GPIO_DEC_RANGE is “0”, only 8 bytes are decoded:</p> <p>Base + 0: index port. Base + 1: data port. Base + 2: GPIO8 data register. Base + 3: GPIO7 data register. Base + 4: GPIO6 data register. Base + 5: GPIO5 data register. Base + 6: GPIO0 data register. Base + 7: GPIO1 data register.</p> <p>If GPIO_DEC_RANGE is set to “1”, more 8 bytes are decoded:</p> <p>Base + 8: GPIO2 data register. Base + 9: GPIO3 data register. Base + 10: GPIO4 data register.</p> <p>Otherwise: Reserved.</p> <p>There are three ways to access the GPIO registers.</p> <ol style="list-style-type: none"> 1. Use configuration register port 0x4E/0x4F (or 0x2E/0x2F), the LDN for GPIO is 0x06. 2. Use GPIO index/data port. Write index to index port first and then read/write the register. 3. Use digital I/O port. The way only access GPIO data register. Write data to this port will control the data output register. And read this port will read the pin status register.

5.1.1.5 Sample Code in C Language

5.1.1.5.1 Control of GP70 to GP77 (DI1 ~ DI8)

```
#define AddrPort 0x4E
#define DataPort 0x4F

<Enter the Extended Function Mode>
WriteByte(AddrPort, 0x87)
WriteByte(AddrPort, 0x87)           // Must write twice to enter Extended mode

<Select Logic Device>
WriteByte(AddrPort, 0x07)
WriteByte(DataPort, 0x06)           // Select logic device 06h

<Output/Input Mode Selection>       // Set GP70 to GP77 input Mode
WriteByte(AddrPort, 0x80)           // Select configuration register 80h
WriteByte(DataPort, 0x0X)           // Set (bit 0~7) = 0 to select GP 70~77 as Input mode.

<Input Value>
WriteByte(AddrPort, 0x82)           // Select configuration register 82h
ReadByte(DataPort, Value)           // Read bit 0~7 (0xFx)= GP70 ~77 as High.

<Leave the Extended Function Mode>
WriteByte(AddrPort, 0xAA)
```

5.1.1.5.2 Control of GP80 to GP87 (DO1 ~ DO8)

```
#define AddrPort 0x4E
#define DataPort 0x4F

<Enter the Extended Function Mode>
WriteByte(AddrPort, 0x87)
WriteByte(AddrPort, 0x87)           // Must write twice to enter Extended mode

<Select Logic Device>
WriteByte(AddrPort, 0x07)
WriteByte(DataPort, 0x06)           // Select logic device 06h

<Output/Input Mode Selection>       // Set GP80 to GP87 output Mode
WriteByte(AddrPort, 0x88)           // Select configuration register 88h
WriteByte(DataPort, 0xFF)           // Set (bit 0~7) = 1 to select GP 80 ~87 as Output mode.

<Output Value>
WriteByte(AddrPort, 0x89)           // Select configuration register 89h
```



```
WriteByte(DataPort, Value) // Set bit 0~7=(0/1) to output GP 80~87 as Low or High
```

<Leave the Extended Function Mode>

```
WriteByte(AddrPort, 0xAA)
```

5.1.1.5.3 Control of GP70 to GP77 & GP30 to GP37 (DI1 ~ DI16)

```
#define AddrPort 0x4E
```

```
#define DataPort 0x4F
```

<Enter the Extended Function Mode>

```
WriteByte(AddrPort, 0x87)
```

```
WriteByte(AddrPort, 0x87) // Must write twice to entering Extended mode
```

<Select Logic Device>

```
WriteByte(AddrPort, 0x07)
```

```
WriteByte(dataPort, 0x06) // Select logic device 06h
```

<Input Mode Selection>

```
// Set GP70 to GP77 input Mode
```

```
WriteByte(AddrPort, 0x80) // Select configuration register 80h
```

```
WriteByte(DataPort, 0x0X) // Set (bit 0~7) = 0 to select GP 70~77 as Input mode
```

<Input Mode Selection>

```
// Set GP30 to GP37 input Mode
```

```
WriteByte(AddrPort, 0xC0) // Select configuration register C0h
```

```
WriteByte(DataPort, 0x0X) // Set (bit 0~7) = 0 to select GP 30~37 as Input mode
```

<input Value>

```
WriteByte(AddrPort, 0x82) // Select configuration register 82h
```

```
ReadByte(DataPort, Value) // Read bit 0~7(0xFx)= GP70~77 as High
```

<input Value>

```
WriteByte(AddrPort, 0xC2) // Select configuration register C2h
```

```
ReadByte(DataPort, Value) // Read bit 0~7(0xFx)= GP30~37 as High
```

<Leave the Extended Function Mode>

```
WriteByte(AddrPort, 0xAA)
```

5.1.1.5.4 Control of GP80 to GP87 & GP40 to GP47 (DO1 ~ DO16)

```
#define AddrPort 0x4E
#define DataPort 0x4F

<Enter the Extended Function Mode>
WriteByte(AddrPort, 0x87)
WriteByte(AddrPort, 0x87)           // Must write twice to entering Extended mode

<Select Logic Device>
WriteByte(AddrPort, 0x07)
WriteByte(DataPort, 0x06)         // Select logic device 06h

<Output Mode Selection>           // Set GP80 to GP87 output Mode
WriteByte(AddrPort, 0x88)         // Select configuration register 88h
WriteByte(DataPort, (0xFF))       // Set (bit 0~7) = 1 to select GP 80~87 as Output mode

<Output Mode Selection>           // Set GP40 to GP47 output Mode
WriteByte(AddrPort, 0xB0)         // Select configuration register B0h
WriteByte(DataPort, (0xFF))       // Set (bit 0~7) = 1 to select GP 40~47 as Output mode

<Output Value>
WriteByte(AddrPort, 0x89)         // Select configuration register 89h
WriteByte(DataPort, Value)        // Set bit 0~7=(0/1) to output GP 80~87 as Low or High

<Output Value>
WriteByte(AddrPort, 0xB1)         // Select configuration register B1h
WriteByte(DataPort, Value)        // Set bit 0~7=(0/1) to output GP 40~47 as Low or High

<Leave the Extended Function Mode>
WriteByte(AddrPort, 0xAA)
```

5.1.1.5 Change base address

```
<Enter the Extended Function Mode>
WriteByte(AddrPort, 0x87)
WriteByte(AddrPort, 0x87)         // Must write twice to enter Extended mode

<Select Logic Device>
WriteByte(AddrPort, 0x07)
WriteByte(dataPort, 0x06)         // Select logic device 06h

WriteByte(AddrPort, 0x60)         // Select configuration register 60h (High Byte address)
```

```
WriteByte(DataPort, (0x0A))
```

```
WriteByte(AddrPort, 0x61) // Select configuration register 61h (Low Byte address)
```

```
WriteByte(DataPort, (0x00))
```

<Leave the Extended Function Mode>

```
WriteByte(AddrPort, 0xAA)
```

Cincoze default GPIO Port base address is 0xA00h

5.1.1.6 DATA Bit Table (DIO)

7	6	5	4	3	2	1	0	bit
0	0	0	0	0	0	0	1	Value
1								/h

= **DI1**
 (Base address
 +3) (0xA03)

7	6	5	4	3	2	1	0	bit
0	0	0	0	0	0	0	1	Value
1								/h

= **DO1**
 (Base address
 +2) (0xA02)

7	6	5	4	3	2	1	0	bit
0	0	0	0	0	0	1	0	Value
2								/h

= **DI2**
 (Base address
 +3) (0xA03)

7	6	5	4	3	2	1	0	bit
0	0	0	0	0	0	1	0	Value
2								/h

= **DO2**
 Base address
 +2) (0xA02)

7	6	5	4	3	2	1	0	bit
0	0	0	0	0	1	0	0	Value
4								/h

= **DI3**
 (Base address
 +3) (0xA03)

7	6	5	4	3	2	1	0	bit
0	0	0	0	0	1	0	0	Value
4								/h

= **DO3**
 Base address
 +2) (0xA02)

7	6	5	4	3	2	1	0	bit
0	0	0	0	1	0	0	0	Value
8								/h

= **DI4**
 (Base address
 +3) (0xA03)

7	6	5	4	3	2	1	0	bit
0	0	0	0	1	0	0	0	Value
8								/h

= **DO4**
 Base address
 +2) (0xA02)

7	6	5	4	3	2	1	0	bit
0	0	0	1	0	0	0	0	Value
10								/h

= **DI5**
 (Base address
 +3) (0xA03)

7	6	5	4	3	2	1	0	bit
0	0	0	1	0	0	0	0	Value
10								/h

= **DO5**
 Base address
 +2) (0xA02)

7	6	5	4	3	2	1	0	bit
0	0	1	0	0	0	0	0	Value
20								/h

= **DI6**
 (Base address
 +3) (0xA03)

7	6	5	4	3	2	1	0	bit
0	0	1	0	0	0	0	0	Value
20								/h

= **DO6**
 Base address
 +2) (0xA02)

7	6	5	4	3	2	1	0	bit
0	1	0	0	0	0	0	0	Value
40								/h

= **DI7**
 (Base address
 +3) (0xA03)

7	6	5	4	3	2	1	0	bit
0	1	0	0	0	0	0	0	Value
40								/h

= **DO7**
 Base address
 +2) (0xA02)

7	6	5	4	3	2	1	0	bit
1	0	0	0	0	0	0	0	Value
80								/h

= **DI8**
 (Base address
 +3) (0xA03)

7	6	5	4	3	2	1	0	bit
1	0	0	0	0	0	0	0	Value
80								/h

= **DO8**
 Base address
 +2) (0xA02)

7	6	5	4	3	2	1	0	bit
0	0	0	0	0	0	0	1	Value
1								/h

= **DI9**
(Base address
+9) (0xA09)

7	6	5	4	3	2	1	0	bit
0	0	0	0	0	0	0	1	Value
1								/h

= **DO9**
(Base address
+10) (0xA10)

7	6	5	4	3	2	1	0	bit
0	0	0	0	0	0	1	0	Value
2								/h

= **DI10**
(Base address
+9) (0xA09)

7	6	5	4	3	2	1	0	bit
0	0	0	0	0	0	1	0	Value
2								/h

= **DO10**
Base address
+10) (0xA10)

7	6	5	4	3	2	1	0	bit
0	0	0	0	0	1	0	0	Value
4								/h

= **DI11**
(Base address
+9) (0xA09)

7	6	5	4	3	2	1	0	bit
0	0	0	0	0	1	0	0	Value
4								/h

= **DO11**
Base address
+10) (0xA10)

7	6	5	4	3	2	1	0	bit
0	0	0	0	1	0	0	0	Value
8								/h

= **DI12**
(Base address
+9) (0xA09)

7	6	5	4	3	2	1	0	bit
0	0	0	0	1	0	0	0	Value
8								/h

= **DO12**
Base address
+10) (0xA10)

7	6	5	4	3	2	1	0	bit
0	0	0	1	0	0	0	0	Value
10								/h

= **DI13**
(Base address
+9) (0xA09)

7	6	5	4	3	2	1	0	bit
0	0	0	1	0	0	0	0	Value
10								/h

= **DO13**
Base address
+10) (0xA10)

7	6	5	4	3	2	1	0	bit
0	0	1	0	0	0	0	0	Value
20								/h

= **DI14**
(Base address
+9) (0xA09)

7	6	5	4	3	2	1	0	bit
0	0	1	0	0	0	0	0	Value
20								/h

= **DO14**
Base address
+10) (0xA10)

7	6	5	4	3	2	1	0	bit
0	1	0	0	0	0	0	0	Value
40								/h

= **DI15**
(Base address
+9) (0xA09)

7	6	5	4	3	2	1	0	bit
0	1	0	0	0	0	0	0	Value
40								/h

= **DO15**
Base address
+10) (0xA10)

7	6	5	4	3	2	1	0	bit
1	0	0	0	0	0	0	0	Value
80								/h

= **DI16**
(Base address
+9) (0xA09)

7	6	5	4	3	2	1	0	bit
1	0	0	0	0	0	0	0	Value
80								/h

= **DO16**
Base address
+10) (0xA10)

5.1.1.7 DIO I/O Port Address (Default Address 0xA00)

Pin Definition	DI8	DI7	DI6	DI5	DI4	DI3	DI2	DI1
Data Bits	7	6	5	4	3	2	1	0
DIO	Digital Input							
I/O Port Address	0xA03							

Pin Definition	DO8	DO7	DO6	DO5	DO4	DO3	DO2	DO1
Data Bits	7	6	5	4	3	2	1	0
DIO	Digital Output							
I/O Port Address	0xA02							

Pin Definition	DI16	DI15	DI14	DI13	DI12	DI11	DI10	DI9
Data Bits	7	6	5	4	3	2	1	0
DIO	Digital Input							
I/O Port Address	0xA09							

Pin Definition	DO16	DO15	DO14	DO13	DO12	DO11	DO10	DO9
Data Bits	7	6	5	4	3	2	1	0
DIO	Digital Output							
I/O Port Address	0xA010							

5.2 DIO Hardware Specification

- XCOM+/ 2XCOM+: Isolated power in V+
- XCOM-/ 2XCOM-: Isolated power in V-
- Isolated power in DC voltage: 9-30V
- 8x / 16x Digital Input (Source Type)
- Input Signal Voltage Level
 - Signal Logic 0: XCOM+ = 9V, $\text{Signal Low} - V_- < 1V$
 $XCOM+ > 9V, \quad V_+ - \text{Signal Low} > 8V$
 - Signal Logic 1: $> XCOM+ - 3V$
- Input Driving Sink Current:
 - Minimal: 1 mA
 - Normal: 5 mA
- 8x / 16x Digital Output (Open Drain)
 - DO Signal have to pull up resistor to XCOM+ for external device, the resistance will affect the pull up current
 - Signal High Level: Pull up resistor to XCOM+
 - Signal Low Level: = XCOM-
 - Sink Current: 1A (Max)

5.2.1 DIO Connector Definition

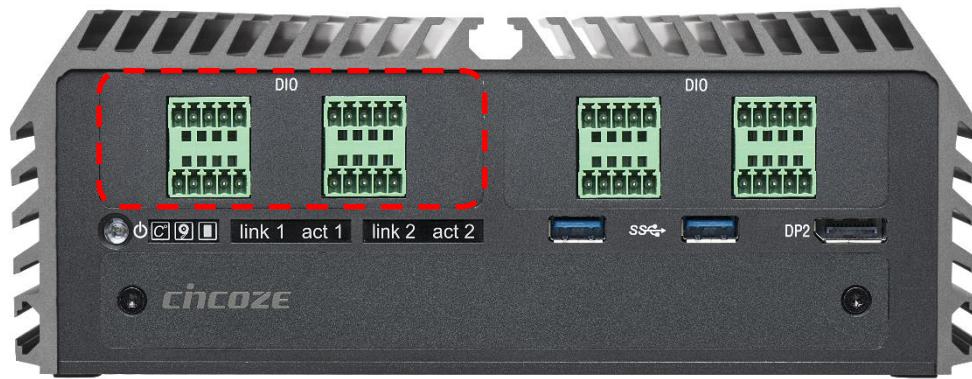

DIO1: Digital Input / Output Connector

Connector Type: Terminal Block 2X5 10-pin, 3.5mm pitch

Pin	Definition	Pin	Definition
1	DI1	11	DO1
2	DI2	12	DO2
3	DI3	13	DO3
4	DI4	14	DO4
5	XCOM+ (DC INPUT)	15	XCOM- (GND)

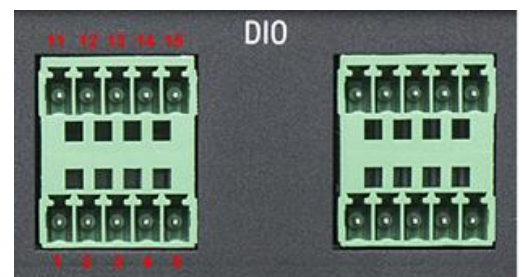

Pin	Definition	Pin	Definition
6	DI5	16	DO5
7	DI6	17	DO6
8	DI7	18	DO7
9	DI8	19	DO8
10	2XCOM+ (DC INPUT)	20	2XCOM- (GND)

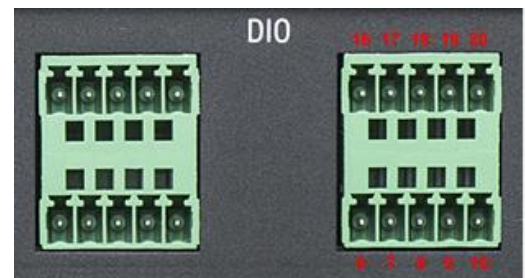

Reference Input Circuit

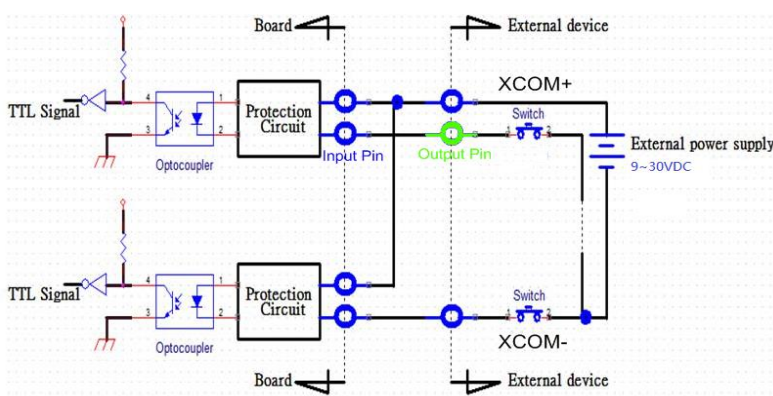

Digital Input Wiring

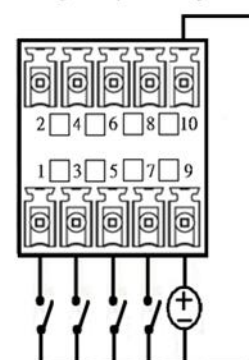

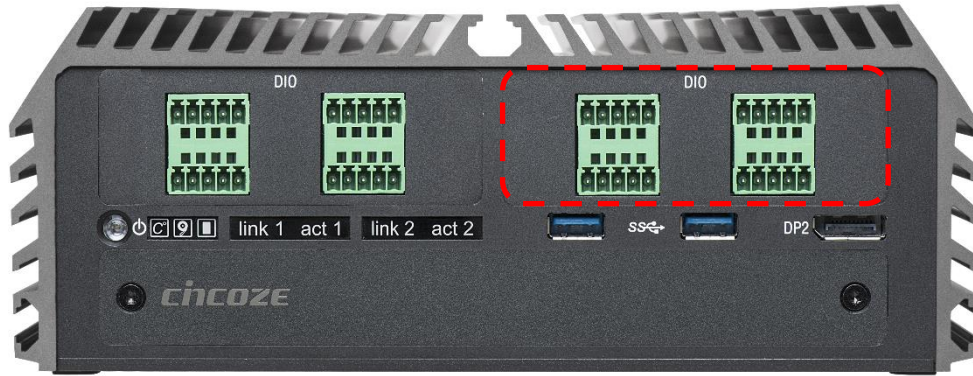

DIO2: Digital Input / Output Connector

Connector Type: Terminal Block 2X5 10-pin, 3.5mm pitch

Pin	Definition	Pin	Definition
1	DI1 (DI9)	11	DO1 (DO9)
2	DI2 (DI10)	12	DO2 (DO10)
3	DI3 (DI11)	13	DO3 (DO11)
4	DI4 (DI12)	14	DO4 (DO12)
5	XCOM+ (DC INPUT)	15	XCOM- (GND)

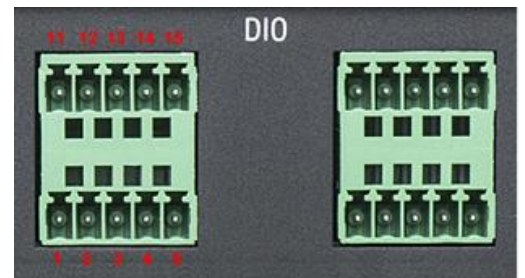

Pin	Definition	Pin	Definition
6	DI5 (DI13)	16	DO5 (DO13)
7	DI6 (DI14)	17	DO6 (DO14)
8	DI7 (DI15)	18	DO7 (DO15)
9	DI8 (DI16)	19	DO8 (DO16)
10	2XCOM+ (DC INPUT)	20	2XCOM- (GND)

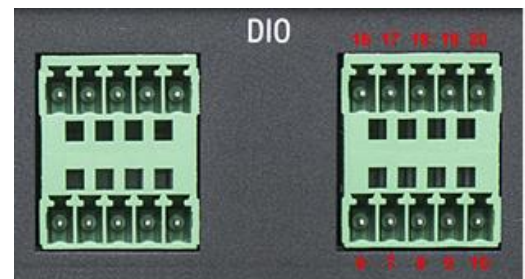

Reference Output Circuit

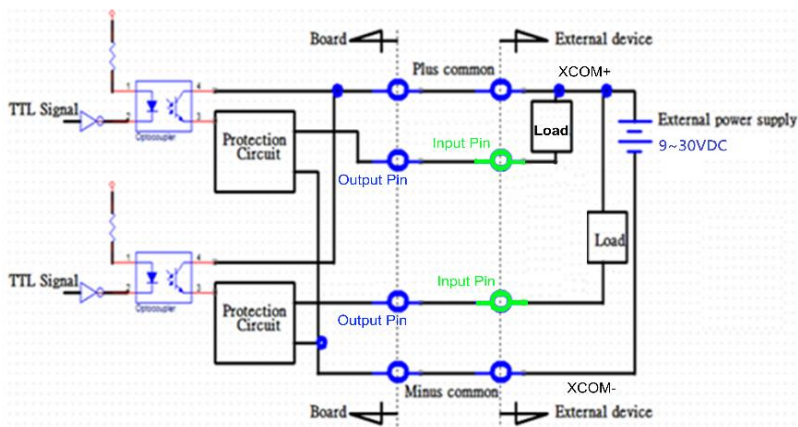

Digital Output Wiring

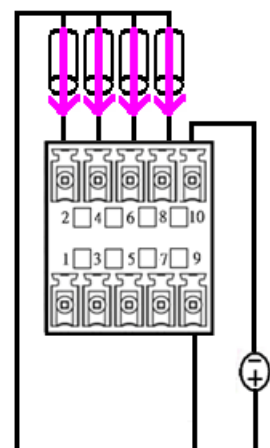



Chapter 6

Optional Modules

Pin Definitions and Settings

6.1 CMI-COM Connector Definition and Settings

Model No.	Product Description
CMI-COM02/UB1004	CMI Module with 4x RS232/422/485 Serial Ports, 1x Universal Bracket with 4x DB9 Cutout
CMI-ICOM01/UB1004	CMI Module with 4x Electrical Isolated RS-232 Serial Ports, 1x Universal Bracket with 4x DB9 Cutout

CMI-COM02/UB1004:

COM3~COM6: RS232/ RS422/ RS485 Connector, Connector Type: 9-pin D-Sub

Pin	RS232 Definition	RS422 / 485 Full Duplex Definition	RS485 Half Duplex Definition
1	DCD	TX-	DATA -
2	RXD	TX+	DATA +
3	TXD	RX+	
4	DTR	RX-	
5	GND		
6	DSR		
7	RTS		
8	CTS		
9	RI		



COM3~COM6 Voltage Function Setting: Pin Define SW1 Switch

Dip	Function	Definition	
1-2	COM3	0V(RI)	ON/ON (Default)
		5V	ON/OFF
		12V	OFF/OFF
3-4	COM4	0V(RI)	ON/ON (Default)
		5V	ON/OFF
		12V	OFF/OFF
5-6	COM5	0V(RI)	ON/ON (Default)
		5V	ON/OFF
		12V	OFF/OFF
7-8	COM6	0V(RI)	ON/ON (Default)
		5V	ON/OFF
		12V	OFF/OFF

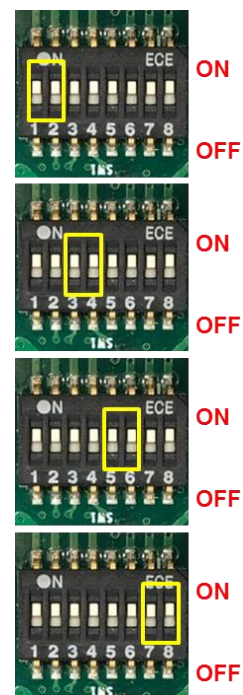

CMI-ICOM01/UB1004:

COM3~COM6: RS232 Connector, Connector Type: 9-pin D-Sub

Pin	RS232 Definition
1	DCD
2	RXD
3	TXD
4	DTR
5	GND
6	DSR
7	RTS
8	CTS
9	RI



NOTE

COM3/4/5/6 are isolated COM, each pin5 (GND) is independent.

6.2 CMI-M12 Connector Definition and Settings

CMI-M12LAN01 Module Pin Definitions

Connector Type: M12 A coded 8pin connector

Pin	Definition	Pin	Definition
1	2_LAN1_0+	2	2_LAN1_0-
3	2_LAN1_1+	4	2_LAN1_2+
5	2_LAN1_2-	6	2_LAN1_1-
7	2_LAN1_3+	8	2_LAN1_3-

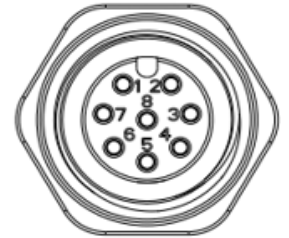

CMI-XM12LAN01 Module Pin Definitions

Connector Type: M12 X coded 8pin connector

Pin	Definition	Pin	Definition
1	D1+	2	D1-
3	D2+	4	D2-
5	D4+	6	D4-
7	D3-	8	D3+

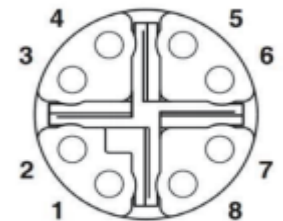

6.3 CFM-IGN Connector Definition and Settings

Model No.	Product Description
CFM-IGN101	CFM Module with Power Ignition Sensing Control Function, 12V/24V Voltage Detection Selectable

SW2: IGN Function Switch

Set shutdown delay timer when ACC is turned off

Pin 1	Pin 2	Pin 3	Pin 4	Definition
OFF (IGN Disabled)	ON	ON	ON	0 second
	ON	ON	OFF	1 minute
	ON	OFF	ON	5 minutes
	ON	OFF	OFF	10 minutes
/ ON (IGN Enabled)	OFF	ON	ON	30 minutes
	OFF	ON	OFF	1 hour
	OFF	OFF	ON	2 hours
	OFF	OFF	OFF	Reserved (0 second)

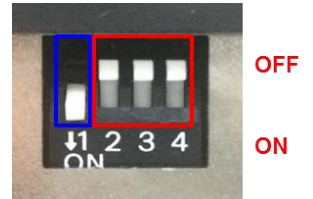

24V_12V_1: 12V / 24V Car Battery Switch

Pin	Definition
1-2 (Right)	24V Car Battery Input
2-3 (Left)	12V Car Battery Input



6.4 Installing Low Speed CMI Modules

The applicable low speed CMI modules for DS-1200 series are listed in the following table.

Model No.	Product Description
CMI-COM02/UB1004	CMI Module with 4x RS232/422/485 Serial Ports, 1x Universal Bracket with 4x DB9 Cutout
CMI-ICOM01/UB1004	CMI Module with 4x Electrical Isolated RS-232 Serial Ports, 1x Universal Bracket with 4x DB9 Cutout
CMI-DIO02/UB1018	CMI Module with 16x Optical Isolated DIO (8 in/8 out), 1x Universal Bracket with DIO Cutout



NOTE

The photo example used in this section is illustrated CMI-ICOM01/UB1004 module.

1. Loosen the 2 hex nuts from back side of front bezel. Remove the front bezel.



2. Locate the connector of CMI-module on the top side of system.

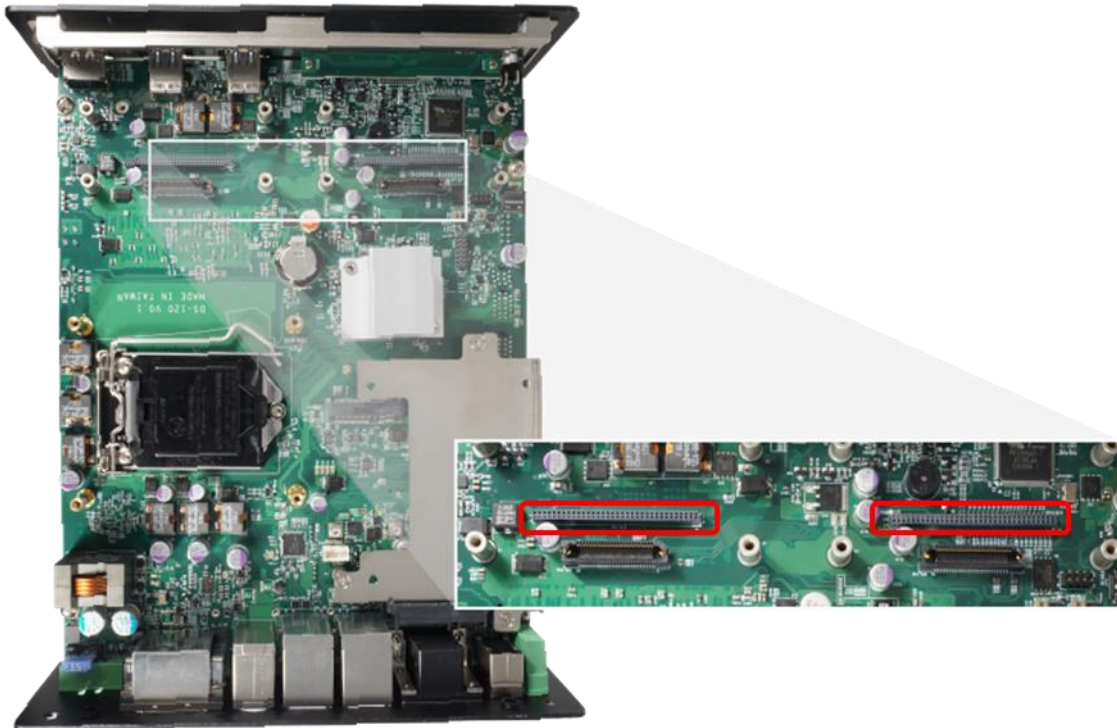

3. Insert the CMI module carefully into the CMI connector on the main board. Fix it with 4 screws.



4. Fasten the 2 hex nuts from the back side of front bezel.

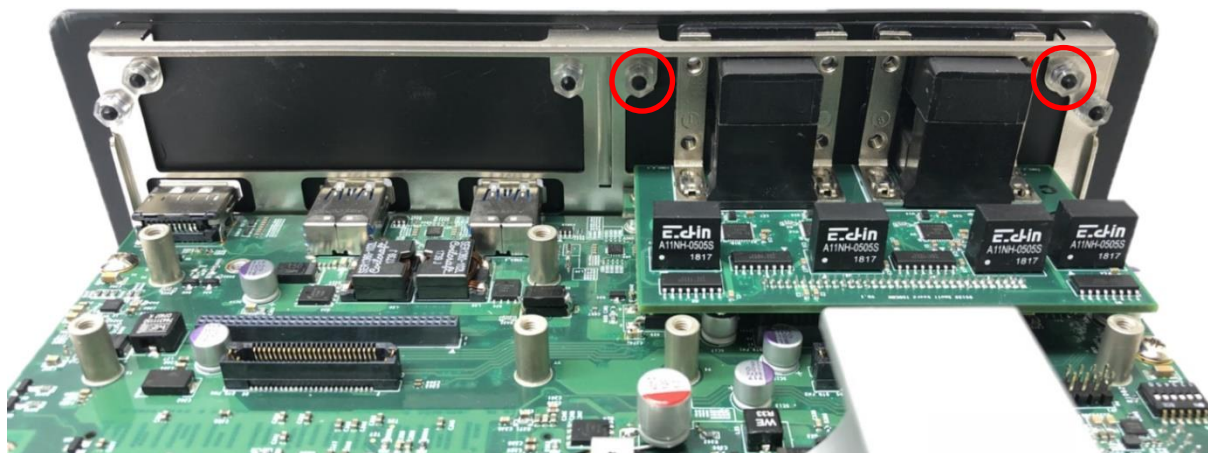

5. Fasten the 8 D-Sub jack screws as marked on photo.



6.5 Installing High Speed CMI Modules

The applicable high speed CMI modules for DS-1200 series are CMI-LAN01-R12/UB1012, CMI-M12LAN01-R12/UB1010, and CMI-XM12LAN01-R10/UB1030.

6.5.1 CMI-M12LAN01-R10/UB1010 Module

1. Loosen the 2 hex nuts from back side of front bezel. Remove the front bezel.



2. Locate the connector of CMI module on top side of system.

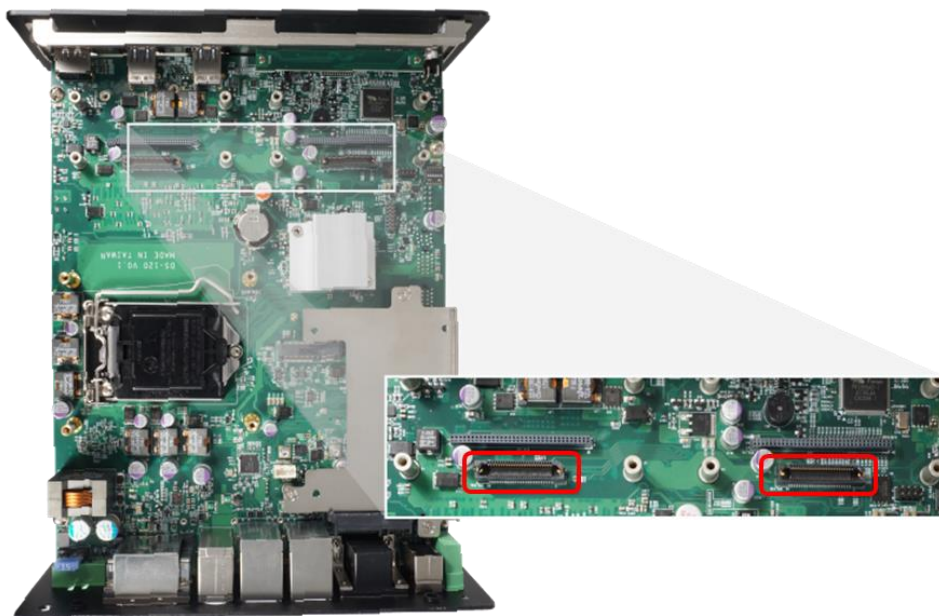

3. Remove the 4 ring nuts from M12 jack before attempting to install the module.

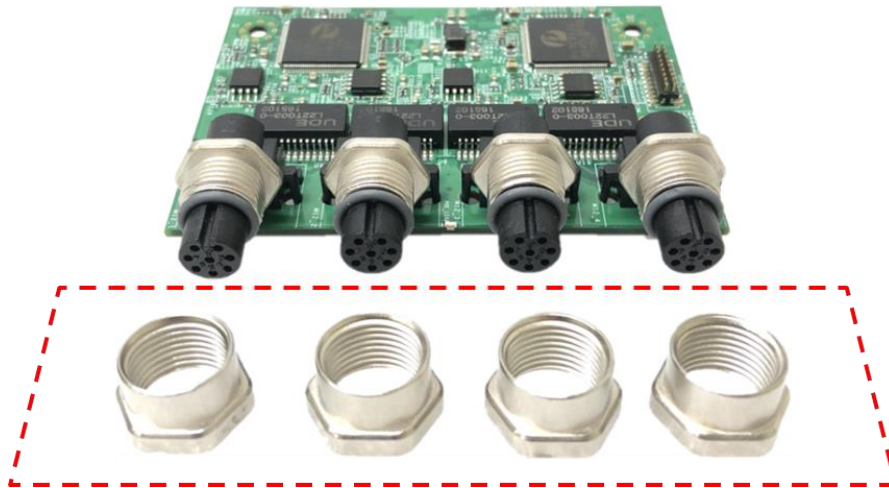

4. Insert the CMI module vertically into the female connector on system's mainboard until it's connected firmly and fasten 4 screws to fix it.

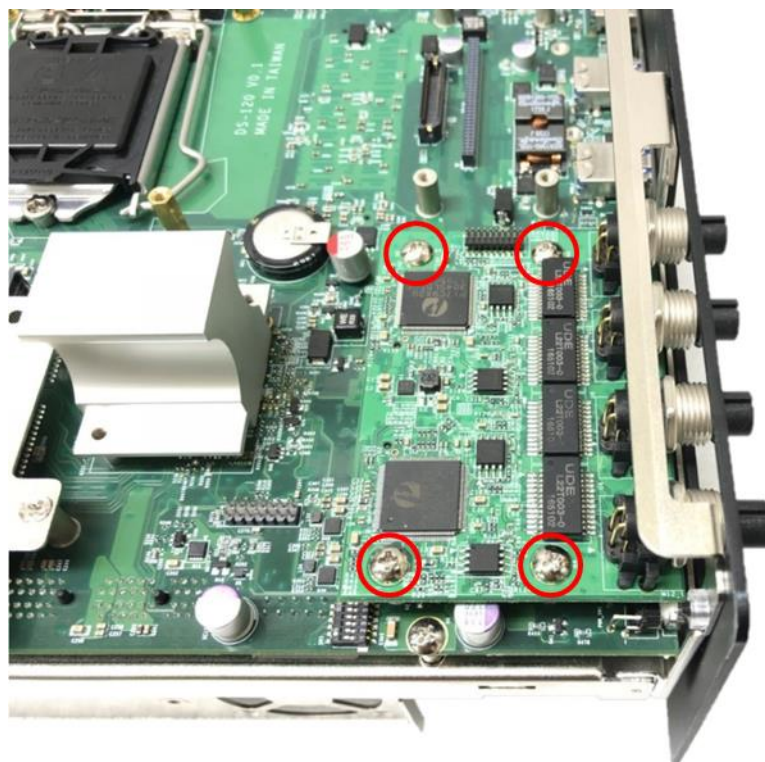

5. Attach the M12 I/O bracket.



6. Fasten 2 hex nuts from the back side of the bracket.

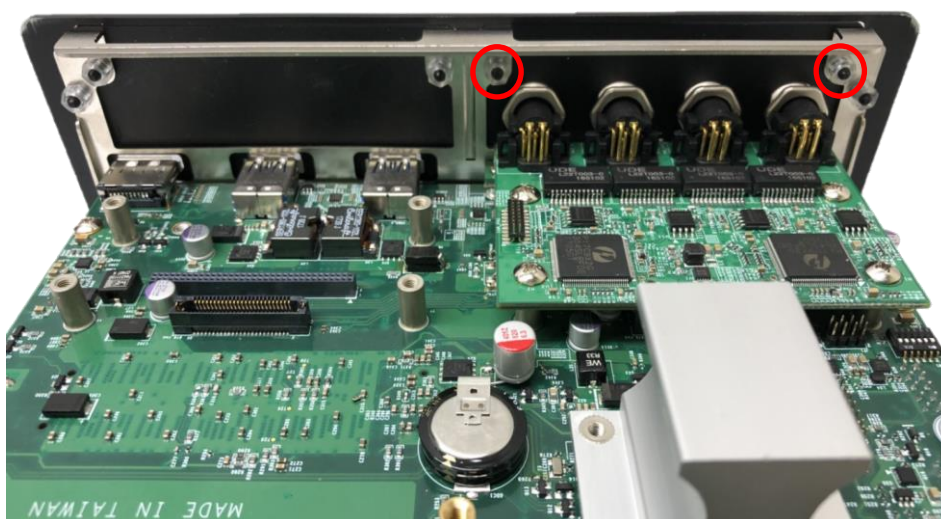

7. Fasten the 4 ring nuts onto M12 jacks.



6.5.2 CMI-XM12LAN01-R10/UB1030 Module

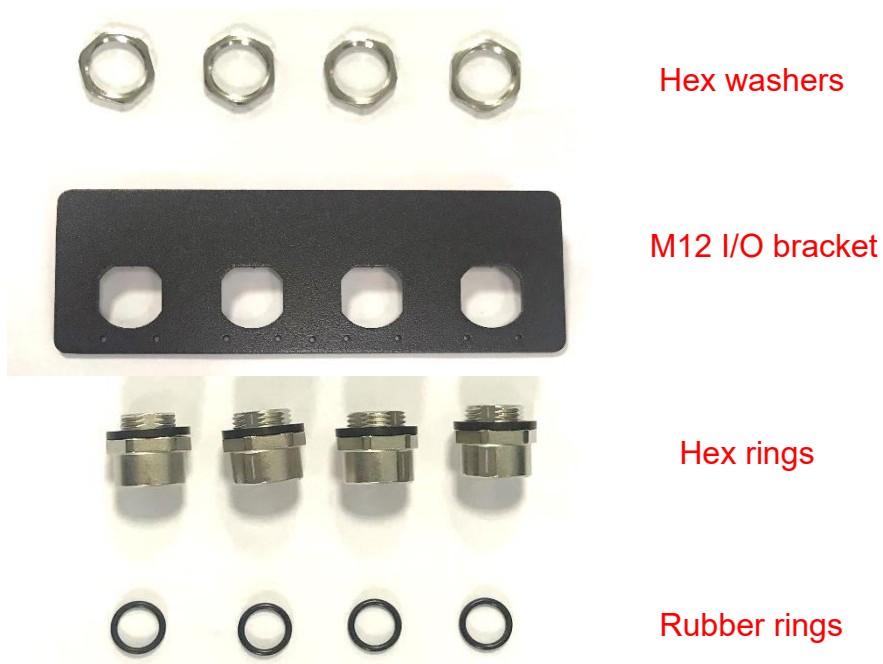

1. Assemble the hex rings, M12 I/O bracket and hex washers together as indicated below:
Penetrate hex rings through the M12 I/O bracket holes, and fix them with hex washers.



2. Loosen the 2 hex nuts from back side of front bezel. Remove the front bezel.



3. Locate the connector of CMI module on top side of system.

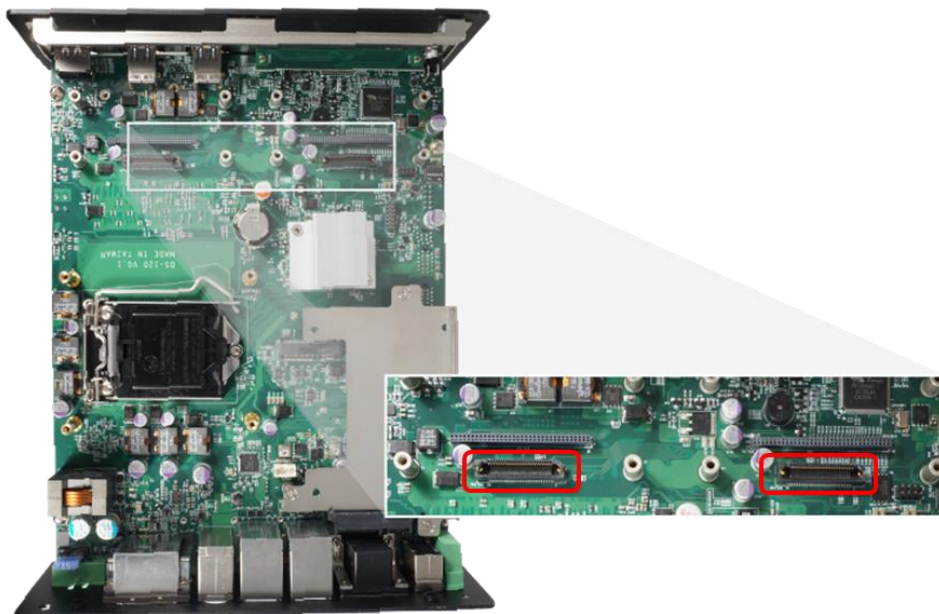

4. Insert the CMI module vertically into the female connector on system's mainboard until it's connected firmly and fasten 4 screws to fix it.

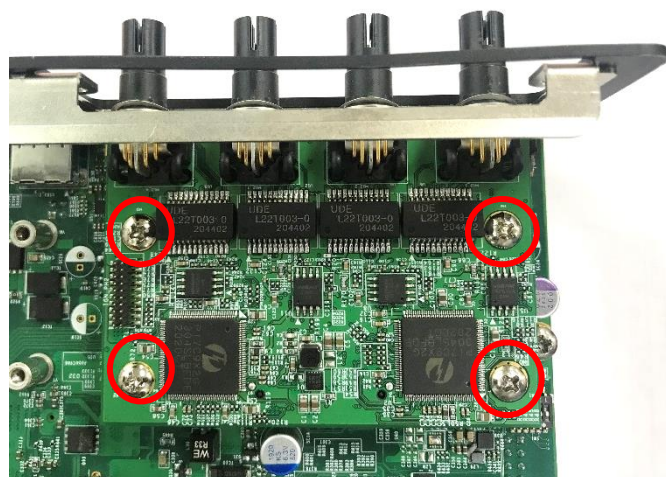

5. Attach the assembled M12 I/O bracket on to the system, and fasten the hex nuts to fix it.

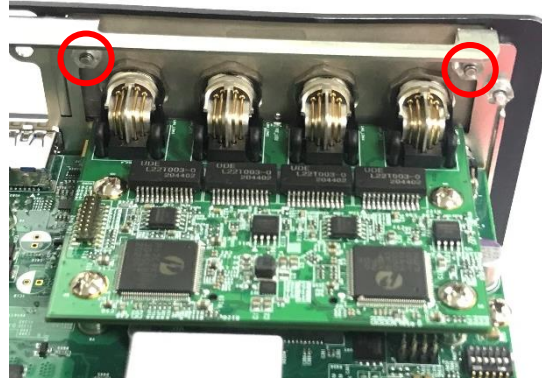
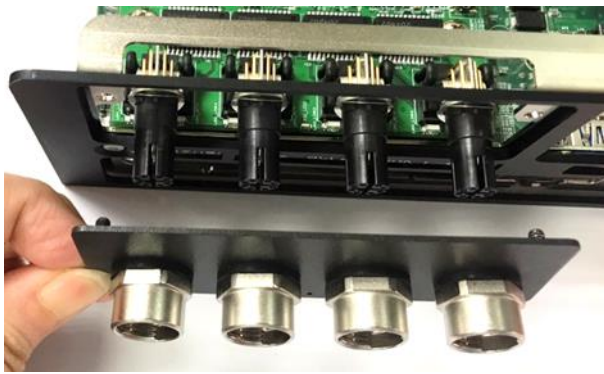

6. Put on the rubber rings to the four M12 LAN ports.

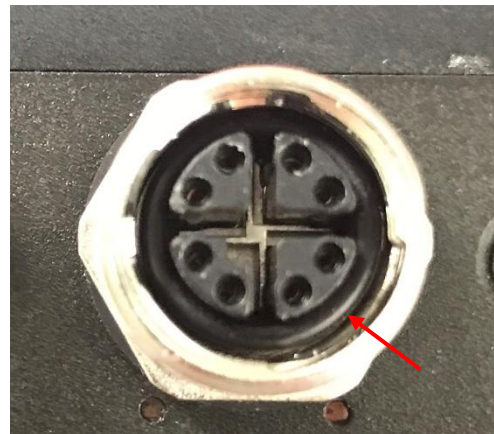

6.6 Installing CFM-PoE Module

If you use CMI-LAN01-R12 Module, please paste the shading tape to the place which was marked by red frame. If you use CMI-M12LAN01-R12 Module please skip this step.

(Please don't block the LED.)

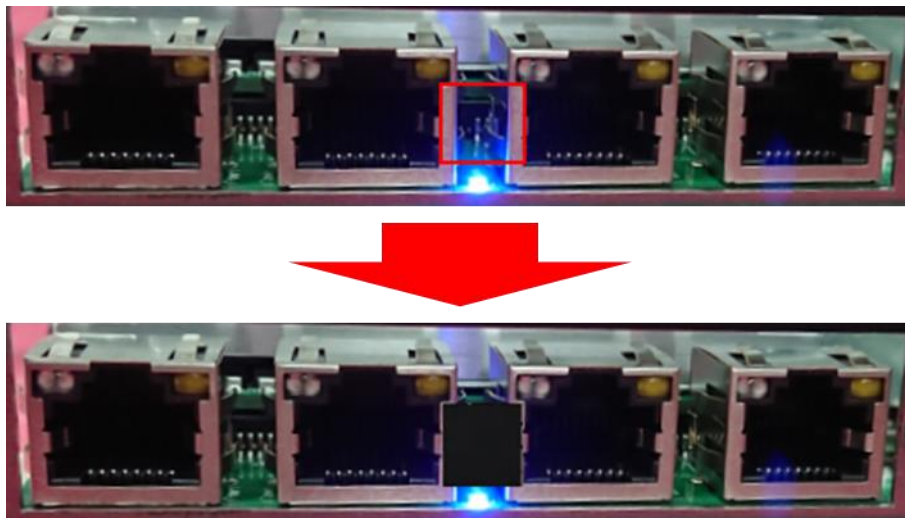

1. Insert the CMI module vertically into the female connector on system's mainboard until it's connected firmly and fasten 4 copper pillars to fix it.

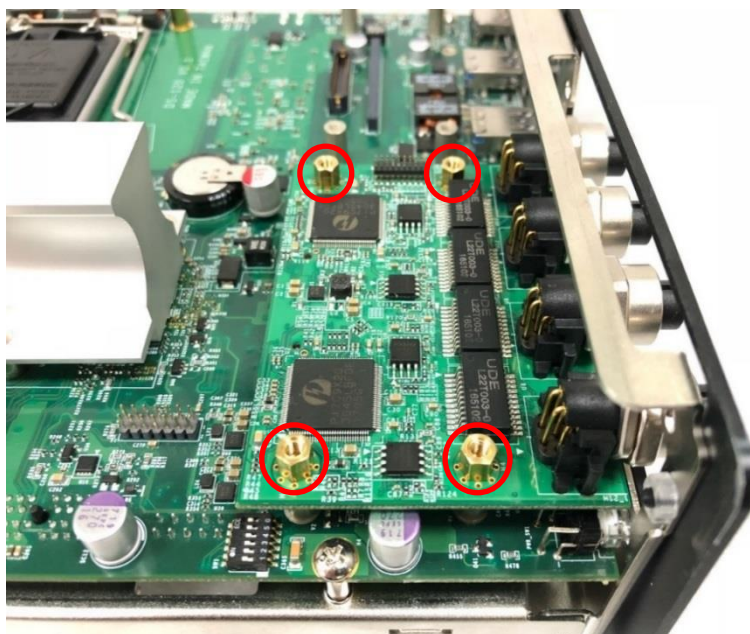

2. Insert the CFM-PoE module vertically into the female connector on CMI module until it's connected firmly.



3. Turn over the heatsink and locate the two places which were marked by red circles.

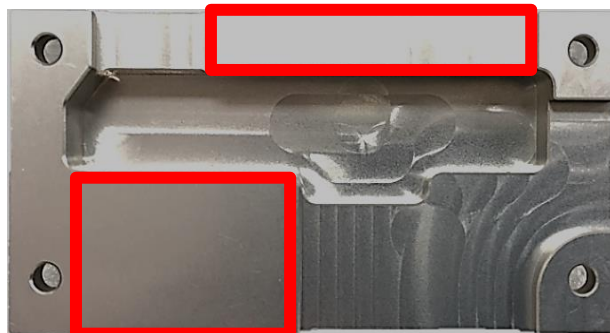

4. Please paste the 2 thermal pads onto the heatsink carefully.

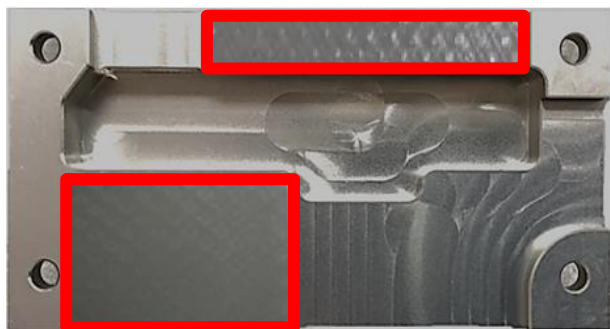

CAUTION

Before putting on the heatsink (in the step 6), please make sure the protective films on the Thermal Pads have been removed!

5. Please paste the thermal pad onto the coil of the CFM-PoE module carefully.



CAUTION

Before putting on the heatsink (in the step 6), please make sure the protective film on the Thermal Pad has been removed!

6. Please paste the heatsink onto the CFM-PoE module carefully.

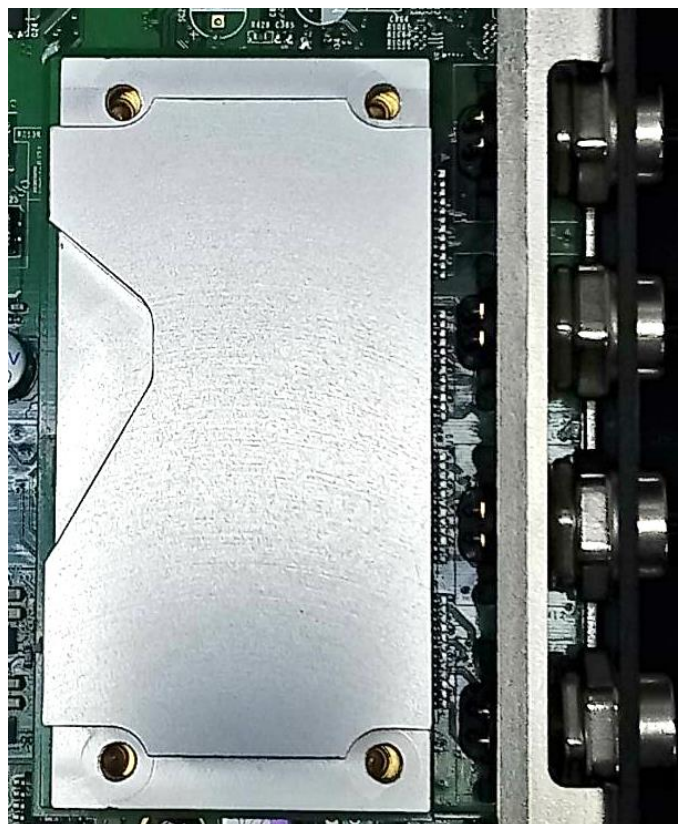

7. Fasten 4 screws to fix it.

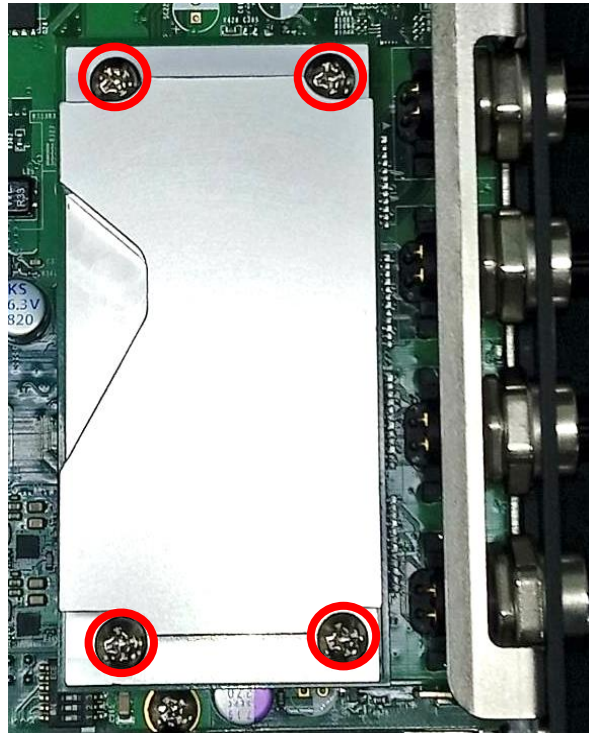

8. Please paste the thermal pad onto the heatsink carefully.

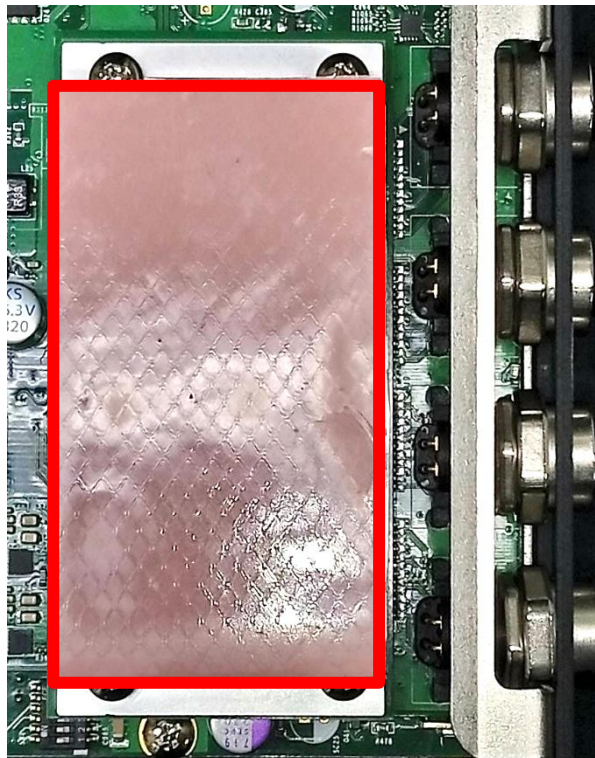

CAUTION

Note: Before assembling the system's chassis cover, please make sure the protective film on the Thermal Pad has been removed!

6.7 Installing CFM-IGN Module

1. Locate power ignition connector on main board.

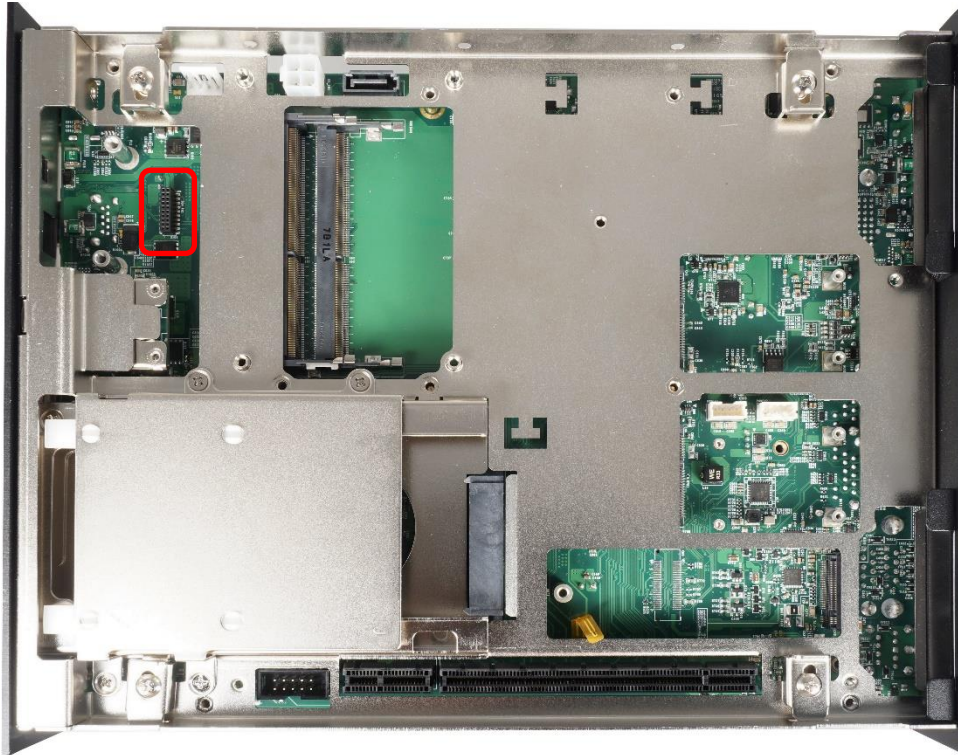

2. Insert the power ignition module carefully into the connector on main board. Fasten 2 screws to fix it.



6.8 Installing External FAN

Model No.	Product Description
FAN-EX101	External Fan with 4pin Terminal Block Plug, Mounting Bracket. Support Smart Fan Function

1. Prepare an external fan. Loosen the 2 screws halfway on mounting frame before attempting to install it.



2. Slide the FAN into the middle groove of chassis as illustrated. Tighten the 2 screws to fix it onto chassis.

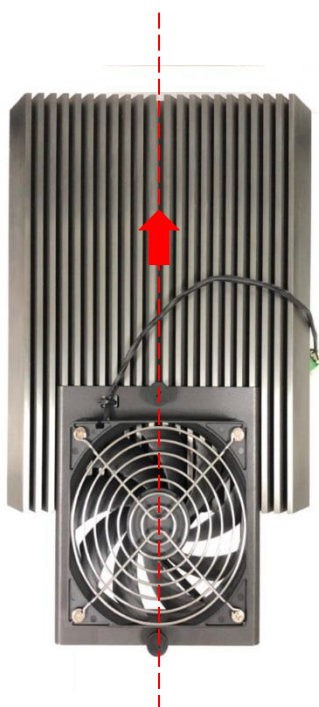

3. Move the fan to the center of chassis. Tighten the 2 screws marked on photo to secure it.

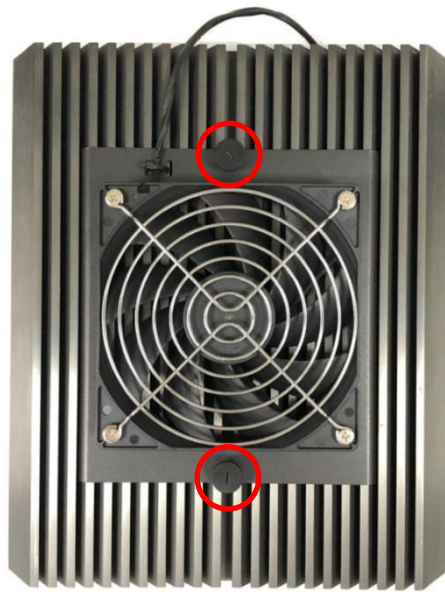

4. Connect the FAN cable to external fan power connector at rear panel.



6.9 Installing Internal FAN (For DS-1202 only)

Model No.	Product Description
FAN-UB100	Exhaling Fan with 4pin Connector, Universal Bracket
FAN-UB101	Inhaling Fan with 4pin Connector, Universal Bracket

1. Unscrew 6 screws to remove 3 I/O brackets from rear panel.



2. Attach the FAN from back side of rear panel. Fasten 4 screws to fix it.



3. Connect the FAN power cable to the power connector on main board.as marked on photo.

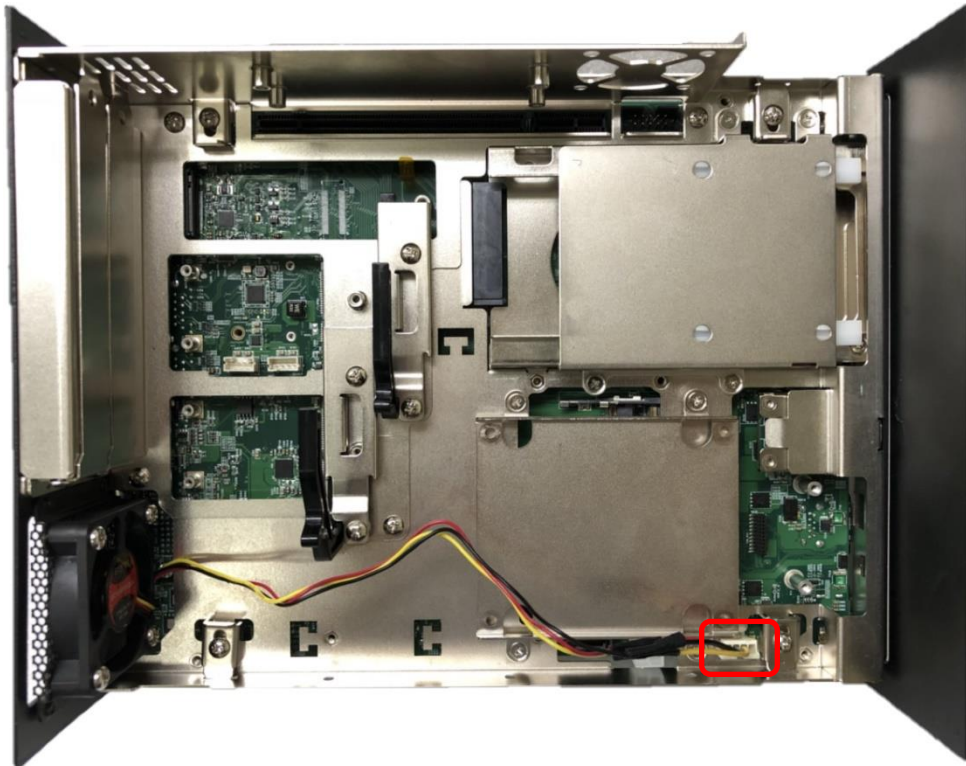

cincoze

© 2020 Cincoze Co., Ltd. All rights reserved.

The Cincoze logo is a registered trademark of Cincoze Co., Ltd.

All other logos appearing in this catalog are the intellectual property of the respective company, product, or organization associated with the logo.

All product specifications and information are subject to change without notice.