

***cincoze***

# CS-100/P1301 Series

## User Manual



**Power Efficient Sunlight Readable Industrial Panel PC**

8.4"~24" TFT-LCD Sunlight Readable Panel PC with Intel® Alder Lake-N Series Processor

# Contents

Preface.....	5
Revision .....	5
Copyright Notice .....	5
Acknowledgement .....	5
Disclaimer.....	5
Declaration of Conformity.....	6
Product Warranty Statement .....	6
Technical Support and Assistance .....	7
Conventions Used in this Manual .....	8
Safety Precautions.....	8
Package Contents .....	9
Ordering Information .....	10
Chapter 1 Product Introductions .....	12
1.1 Overview .....	13
1.2 Specifications .....	13
1.2.1 CS-108C/P1301 Series .....	15
1.2.2 CS-110HC/P1301 Series.....	19
1.2.3 CS-112HC/P1301 Series.....	23
1.2.4 CS-115C/P1301 Series .....	27
1.2.5 CS-117C/P1301 Series .....	31
1.2.6 CS-119C/P1301 Series .....	35
1.2.7 CS-W121C/P1301 Series.....	39
1.2.8 CS-W124C/P1301 Series.....	43
1.3 External Layout.....	47
1.3.1 Front .....	47
1.3.2 Rear.....	47
1.3.3 Left.....	48
1.3.4 Right.....	48
Chapter 2 Introduction to Switches & Connectors .....	49
2.1 Location of Switches and Connectors .....	50
2.1.1 Top View .....	50
2.1.2 Bottom View .....	50
2.2 Switches and Connectors Definition .....	51
2.3 Definition of Switches .....	52
2.4 Definition of Connectors .....	54
2.5 Optional Module Pin Definition & Settings.....	58
2.5.1 CFM-IGN101 Module.....	58
Chapter 3 System Setup .....	59

3.1 Removing Top Cover.....	60
3.2 Installing SO-DIMM Memory .....	61
3.3 Installing M.2 Key B Card.....	62
3.3.1 M.2 Key B type 3052.....	62
3.3.2 M.2 Key B type 3042.....	63
3.4 Installing M.2 Key E Card .....	64
3.5 Installing Antenna(s) .....	65
3.6 Installing CPU Thermal Pad .....	67
3.7 Installing Top Cover .....	68
3.8 Installing SATA Hard Drive .....	69
3.9 Installing SIM Card.....	71
3.10 Installing CFM Modules.....	72
3.10.1 CFM-IGN101 .....	72
3.10.2 CFM-PoE02 .....	73
3.11 Disassembling the CS Display Module .....	75
3.12 Installing Panel Mount .....	75
3.13 Installing VESA Mount.....	78
3.14 Installing Rack Mount.....	79
Chapter 4 BIOS Setup.....	82
4.1 BIOS Introduction.....	83
4.2 Main Setup.....	84
4.3 Advanced Setup .....	85
4.3.1 CPU Configuration .....	85
4.3.2 SATA Configuration .....	86
4.3.3 PCH-FW Configuration.....	86
4.3.4 Trusted Computing Settings.....	87
4.3.5 ACPI Settings.....	89
4.3.6 F81966 Super IO Configuration .....	89
4.3.7 Hardware Monitor.....	91
4.3.8 S5 RTC Wake Settings.....	91
4.3.9 Serial Port Console Redirection.....	92
4.3.10 USB Configuration .....	92
4.3.11 Network Stack Configuration .....	93
4.3.13 CSM Configuration .....	93
4.3.14 NVMe Configuration.....	94
4.4 Chipset Setup .....	95
4.4.1 System Agent (SA) Configuration .....	95
4.4.2 PCH-IO Configuration .....	96
4.5 Security Setup .....	98
4.6 Boot Setup.....	99

4.7 Save & Exit.....	100
Chapter 5 Product Application .....	101
5.1 Where to download drivers? .....	102
5.2 Where to find the technical documents? .....	102

# Preface

## Revision

Revision	Description	Date
1.00	First Released	2024/01/22
1.01	Correction Made	2024/03/26
1.10	OS Spec Updated	2024/04/19
1.11	Information about UL Certification Added	2024/06/05

## Copyright Notice

© 2024 by Cincoze Co., Ltd. All rights are reserved. No parts of this manual may be copied, modified, or reproduced in any form or by any means for commercial use without the prior written permission of Cincoze Co., Ltd. All information and specification provided in this manual are for reference only and remain subject to change without prior notice.

## Acknowledgement

Cincoze is a registered trademark of Cincoze Co., Ltd. All registered trademarks and product names mentioned herein are used for identification purposes only and may be trademarks and/or registered trademarks of their respective owners.

## Disclaimer

This manual is intended to be used as a practical and informative guide only and is subject to change without notice. It does not represent a commitment on the part of Cincoze. This product might include unintentional technical or typographical errors. Changes are periodically made to the information herein to correct such errors, and these changes are incorporated into new editions of the publication.

## Declaration of Conformity



### FCC

This equipment has been tested and found to comply with the limits for a Class A digital device, pursuant to Part 15 of the FCC Rules. These limits are designed to provide reasonable protection against harmful interference when the equipment is operated in a commercial environment. This equipment generates, uses, and can radiate radio frequency energy and, if not installed and used in accordance with the instruction manual, may cause harmful interference to radio communications. Operation of this equipment in a residential area is likely to cause harmful interference in which case the user will be required to correct the interference at his own expense.



### CE

The product(s) described in this manual complies with all application European Union (CE) directives if it has a CE marking. For computer systems to remain CE compliant, only CE-compliant parts may be used. Maintaining CE compliance also requires proper cable and cabling techniques.

## Product Warranty Statement

### Warranty

Cincoze products are warranted by Cincoze Co., Ltd. to be free from defect in materials and workmanship for 2 years from the date of purchase by the original purchaser. During the warranty period, we shall, at our option, either repair or replace any product that proves to be defective under normal operation. Defects, malfunctions, or failures of the warranted product caused by damage resulting from natural disasters (such as by lightning, flood, earthquake, etc.), environmental and atmospheric disturbances, other external forces such as power line disturbances, plugging the board in under power, or incorrect cabling, and damage caused by misuse, abuse, and unauthorized alteration or repair, and the product in question is either software, or an expendable item (such as a fuse, battery, etc.), are not warranted.

### RMA

Before sending your product in, you will need to fill in Cincoze RMA Request Form and obtain an RMA number from us. Our staff is available at any time to provide you with the most friendly and immediate service.

#### ■ RMA Instruction

- Customers must fill in Cincoze Return Merchandise Authorization (RMA) Request Form and obtain an RMA number prior to returning a defective product to Cincoze for service.
- Customers must collect all the information about the problems encountered and note anything abnormal and describe the problems on the “Cincoze Service Form”

for the RMA number apply process.

- Charges may be incurred for certain repairs. Cincoze will charge for repairs to products whose warranty period has expired. Cincoze will also charge for repairs to products if the damage resulted from acts of God, environmental or atmospheric disturbances, or other external forces through misuse, abuse, or unauthorized alteration or repair. If charges will be incurred for a repair, Cincoze lists all charges, and will wait for customer's approval before performing the repair.
- Customers agree to ensure the product or assume the risk of loss or damage during transit, to prepay shipping charges, and to use the original shipping container or equivalent.
- Customers can be sent back the faulty products with or without accessories (manuals, cable, etc.) and any components from the system. If the components were suspected as part of the problems, please note clearly which components are included. Otherwise, Cincoze is not responsible for the devices/parts.
- Repaired items will be shipped along with a "Repair Report" detailing the findings and actions taken.

### **Limitation of Liability**

Cincoze' liability arising out of the manufacture, sale, or supplying of the product and its use, whether based on warranty, contract, negligence, product liability, or otherwise, shall not exceed the original selling price of the product. The remedies provided herein are the customer's sole and exclusive remedies. In no event shall Cincoze be liable for direct, indirect, special or consequential damages whether based on contract of any other legal theory.

### **Technical Support and Assistance**

1. Visit the Cincoze website at [www.cincoze.com](http://www.cincoze.com) where you can find the latest information about the product.
2. Contact your distributor or our technical support team or sales representative for technical support if you need additional assistance. Please have following information ready before you call:
  - Product name and serial number
  - Description of your peripheral attachments
  - Description of your software (operating system, version, application software, etc.)
  - A complete description of the problem
  - The exact wording of any error messages

## Conventions Used in this Manual



WARNING  
(AVERTIR)

This indication alerts operators to an operation that, if not strictly observed, may result in severe injury.  
(Cette indication avertit les opérateurs d'une opération qui, si elle n'est pas strictement observée, peut entraîner des blessures graves.)



CAUTION  
(ATTENTION)

This indication alerts operators to an operation that, if not strictly observed, may result in safety hazards to personnel or damage to equipment.  
(Cette indication avertit les opérateurs d'une opération qui, si elle n'est pas strictement observée, peut entraîner des risques pour la sécurité du personnel ou des dommages à l'équipement.)



NOTE  
(NOTE)

This indication provides additional information to complete a task easily.  
(Cette indication fournit des informations supplémentaires pour effectuer facilement une tâche.)

## Safety Precautions

Before installing and using this device, please note the following precautions.

1. Read these safety instructions carefully.
2. Keep this User's Manual for future reference.
3. Disconnect this equipment from any AC outlet before cleaning.
4. For plug-in equipment, the power outlet socket must be located near the equipment and must be easily accessible.
5. Keep this equipment away from humidity.
6. Put this equipment on a reliable surface during installation. Dropping it or letting it fall may cause damage.
7. Make sure the voltage of the power source is correct before connecting the equipment to the power outlet.
8. Use a power cord that has been approved for using with the product and that it matches the voltage and current marked on the product's electrical range label. The voltage and current rating of the cord must be greater than the voltage and current rating marked on the product.
9. Position the power cord so that people cannot step on it. Do not place anything over the power cord.
10. All cautions and warnings on the equipment should be noted.
11. If the equipment is not used for a long time, disconnect it from the power source to avoid damage by transient overvoltage.
12. Never pour any liquid into an opening. This may cause fire or electrical shock.
13. Never open the equipment. For safety reasons, the equipment should be opened only by



qualified service personnel.

If one of the following situations arises, get the equipment checked by service personnel:

- The power cord or plug is damaged.
  - Liquid has penetrated into the equipment.
  - The equipment has been exposed to moisture.
  - The equipment does not work well, or you cannot get it work according to the user's manual.
  - The equipment has been dropped and damaged.
  - The equipment has obvious signs of breakage.
14. CAUTION: Danger of explosion if battery is incorrectly replaced. Replace only with the same or equivalent type recommended by the manufacturer.
  15. Equipment intended only for use in a RESTRICTED ACCESS AREA.
  16. Ensure to connect the power cord of power adapter to a socket-outlet with earthing connection.
  17. Dispose of used battery promptly. Keep away from children. Do not disassemble and do not dispose of in fire.

## Package Contents

Before installation, please ensure all the items listed in the following table are included in the package.

Item	Description	Q'ty
1	CS-100/1301 Series Panel PC	1
2	Thermal Pad (for CPU Thermal Block)	1
3	Power Terminal Block Connector	1
4	Remote Power On/Off Terminal Block Connector	1
5	DIO Terminal Block Connector	2
6	Screws Pack	5
7	Panel Mounting Kit (The quantity varies with the size of the display module, please refer to the datasheet for the actual quantity)	1

*Note: Notify your sales representative if any of the above items are missing or damaged.*

## Ordering Information

### Available Models

<b>Model No.</b>	<b>Product Description</b>
CS-108C-R10/P1301-N97-R10	8.4" TFT-LCD 1600nits Sunlight Readable Touch Panel PC with Intel® Processor N97 Quad Core Processor
CS-108C-R10/P1301-X7425E-R10	8.4" TFT-LCD 1600nits Sunlight Readable Touch Panel PC with Intel® Atom® x7425E Quad Core Processor
CS-110HC-R11/P1301-N97-R10	10.4" TFT-LCD 1500nits Sunlight Readable Touch Panel PC with Intel® Processor N97 Quad Core Processor
CS-110HC-R11/P1301-X7425E-R10	10.4" TFT-LCD 1500nits Sunlight Readable Touch Panel PC with Intel® Atom® x7425E Quad Core Processor
CS-112HC-R11/P1301-N97-R10	12.1" TFT-LCD 1500nits Sunlight Readable Touch Panel PC with Intel® Processor N97 Quad Core Processor
CS-112HC-R11/P1301-X7425E-R10	12.1" TFT-LCD 1500nits Sunlight Readable Touch Panel PC with Intel® Atom® x7425E Quad Core Processor
CS-115C-R11/P1301-N97-R10	15" TFT-LCD 1800nits Sunlight Readable Touch Panel PC with Intel® Processor N97 Quad Core Processor
CS-115C-R11/P1301-X7425E-R10	15" TFT-LCD 1800nits Sunlight Readable Touch Panel PC with Intel® Atom® x7425E Quad Core Processor
CS-117C-R11/P1301-N97-R10	17" TFT-LCD 1500nits Sunlight Readable Touch Panel PC with Intel® Processor N97 Quad Core Processor
CS-117C-R11/P1301-X7425E-R10	17" TFT-LCD 1500nits Sunlight Readable Touch Panel PC with Intel® Atom® x7425E Quad Core Processor
CS-119C-R11/P1301-N97-R10	19" TFT-LCD 1600nits Sunlight Readable Touch Panel PC with Intel® Processor N97 Quad Core Processor
CS-119C-R11/P1301-X7425E-R10	19" TFT-LCD 1600nits Sunlight Readable Touch Panel PC with Intel® Atom® x7425E Quad Core Processor
CS-W121C-R10/P1301-N97-R10	21.5" TFT-LCD 1000nits Sunlight Readable Touch Panel PC with Intel® Processor N97 Quad Core Processor
CS-W121C-R10/P1301-X7425E-R10	21.5" TFT-LCD 1000nits Sunlight Readable Touch Panel PC with Intel® Atom® x7425E Quad Core Processor

---

CS-W124C-R10/P1301-N97-R10

24" TFT-LCD 1500nits Sunlight Readable Touch Panel PC  
with Intel® Processor N97 Quad Core Processor

---

CS-W124C-R10/P1301-X7425E-R10

24" TFT-LCD 1500nits Sunlight Readable Touch Panel PC  
with Intel® Atom® x7425E Quad Core Processor

---



# **Chapter 1**

## **Product Introductions**

# 1.1 Overview

The CS-100/P1301 series is a sunlight-readable panel PC that provides ultra-high brightness of up to 1,800 nits. It is equipped with an Intel® Alder Lake-N processor that provides a complete selection of screen sizes, ratios, and brightnesses. Rich I/O, flexible expansion, rugged, easy on-site maintenance, and other features make the CS-100/P1301 series the best choice for outdoor kiosk or HMI applications

## Key Features

- 8.4”~24” TFT-LCD XGA with Ultra High Brightness
- Onboard Intel® Alder Lake-N Processor N97 and Atom® x7425E Processor
- 1x DDR5 SO-DIMM Socket, Supports up to 4800MHz & 16GB Memory
- 1x M.2 Key E Type 2230 Socket for Wireless/Intel CNVi Module Expansion
- 1x M.2 Key B Type 3042/3052 Socket for 5G/Storage/Add-on Card Expansion
- Front Panel IP65 Compliant
- Designed with Rugged Aluminum Die-casting Front Bezel
- Supports Panel / VESA / Rack Mount
- Supports Cincoze Patent CDS Technology (Patent No. M482908)

### AI & Multitasking Performance

The CS-100/P1301 is equipped with an Intel Alder Lake-N quad-core processor based on the Intel® 7 process. Compared with the previous generation Elkhart Lake platform, the CPU single-thread performance is improved by up to 130%, and the multi-thread performance is improved by 109%. The built-in UHD graphics chip improves AI inference, with 6.85 times the object recognition performance

### CPU Single-Thread Performance Up to 1.30X Improvement



### CPU Multi-Thread Performance Up to 1.09X Improvement



### Convenient Upgrades & Repairs

Cincoze Convertible Display System (CDS) patented technology makes field-side maintenance and future upgrades easier. Replacing a display or improving system performance only requires replacing a single module, which significantly cuts upgrade costs.

Patent No. M482908

## Complete Product Portfolio

The CS-100/P1301 series offers a variety of display options, with screen sizes from 8.4 to 24 inches, support for up to full HD resolution, high brightness up to 1,800 nits, and multi-point P-Cap touchscreen, which can be selected according to application needs.



## Wide Temps, Safe & More Reliable

In order to overcome the harsh outdoor environment and unpredictable climate, the CS-100/P1301 series has a series of industrial-grade protections, including a wide operating temperature range (-20°C to 70°C) that beats the industry standard and an IP65 dustproof/water resistant front panel to ensure a high degree of product safety.

# 1.2 Specifications

## 1.2.1 CS-108C/P1301 Series

Model Name	CS-108C
<b>Display</b>	
LCD Size	• 8.4" (4:3)
Max. Resolution	• 800 x 600
Brightness (cd/m2)	• 1600
Contract Ratio	• 600 : 1
LCD Color	• 16.2M
Pixel Pitch	• 0.213 (H) x 0.213 (V)
Viewing Angle	• 160 (H) / 140 (V)
Backlight MTBF	• 50,000 hrs(LED Backlight)
<b>Touchscreen</b>	
Touchscreen Type	• Projected Capacitive Touch
<b>Physical</b>	
Dimension (WxDxH)	• 262 x 186.2 x 56.2mm
Weight	• 1.58kg
Construction	• Flat Rugged Aluminum Die-casting Bezel
<b>Environment</b>	
Front Panel Protection	• IP 65 Compliant
Operating Temperature	• Ambient with Air flow: -20°C to 70°C (extended temperature peripherals)
Storage Temperature	• -20°C to 70°C
Relative Humidity	• 85% RH @ 40°C (non-condensing)
EMC	• CE, UKCA, FCC, ICES-003 Class A
EMI	<ul style="list-style-type: none"> <li>• CISPR 32 Conducted &amp; Radiated: Class A</li> <li>• EN/BS EN 55032 Conducted &amp; Radiated: Class A</li> <li>• EN/BS EN IEC 61000-3-2 Harmonic current emissions: Class A</li> <li>• EN/BS EN61000-3-3 Voltage fluctuations &amp; flicker</li> <li>• FCC 47 CFR Part 15B, ICES-003 Conducted &amp; Radiated: Class A</li> </ul>
EMS	<ul style="list-style-type: none"> <li>• EN/IEC 61000-4-2 ESD: Contact: 4 kV; Air: 8 kV</li> <li>• EN/IEC 61000-4-3 RS: 80 MHz to 1000 MHz: 3 V/m</li> <li>• EN/IEC 61000-4-4 EFT: AC Power: 1 kV; DC Power: 0.5 kV; Signal: 0.5 kV</li> <li>• EN/IEC 61000-4-5 Surges: AC Power: 2 kV; Signal: 1 kV</li> <li>• EN/IEC 61000-4-6 CS: 3V</li> <li>• EN/IEC 61000-4-8 PFMF: 50 Hz, 1A/m</li> <li>• EN/IEC 61000-4-11 Voltage Dips &amp; Voltage Interruptions: 0.5 cycles at 50 Hz</li> </ul>
Safety	• UL, cUL, CB, IEC, EN 62368-1

Model Name	P1301
<b>System</b>	
Processor	<ul style="list-style-type: none"> <li>Onboard Intel® Alder Lake-N Series Processor: <ul style="list-style-type: none"> <li>Intel® Processor N97 4 Cores Up to 3.60 GHz, TDP 12W</li> <li>Intel Atom® x7425E 4 Cores Up to 3.40 GHz, TDP 12W</li> </ul> </li> </ul>
Memory	<ul style="list-style-type: none"> <li>1x DDR5 4800MHz SO-DIMM Socket</li> <li>Supports Un-buffered and Non-ECC Type, Up to 16GB</li> </ul>
BIOS	<ul style="list-style-type: none"> <li>AMI BIOS</li> </ul>
<b>Graphics</b>	
Graphics Engine	<ul style="list-style-type: none"> <li>Integrated Intel® UHD Graphics</li> </ul>
Maximum Display Output	<ul style="list-style-type: none"> <li>Supports Triple Independent Display</li> </ul>
CDS	<ul style="list-style-type: none"> <li>1x CDS Connector (1920 x 1080 @ 60Hz)</li> </ul>
DP	<ul style="list-style-type: none"> <li>1x DisplayPort Connector (4096 x 2304 @ 60Hz)</li> <li>* Verified maximum resolution: 3840x2160 @ 60Hz</li> </ul>
VGA	<ul style="list-style-type: none"> <li>1x VGA Connector (1920 x 1200 @60Hz)</li> </ul>
<b>Audio</b>	
Audio Codec	<ul style="list-style-type: none"> <li>Realtek® ALC888, High Definition Audio</li> </ul>
Line-out	<ul style="list-style-type: none"> <li>1x Line-out, Phone Jack 3.5mm</li> </ul>
Mic-in	<ul style="list-style-type: none"> <li>1x Mic-in, Phone Jack 3.5mm</li> </ul>
<b>I/O</b>	
LAN	<ul style="list-style-type: none"> <li>2x 2.5GbE LAN, RJ45</li> <li>- GbE1 / GbE2: Intel® I225</li> </ul>
COM	<ul style="list-style-type: none"> <li>2x RS-232/422/485 with Auto Flow Control Support 5V/12V, DB9</li> </ul>
USB	<ul style="list-style-type: none"> <li>3x 10Gbps USB 3.2 Gen2x1, Type A</li> <li>1x 480Mbps USB 2.0, Type A</li> </ul>
DIO	<ul style="list-style-type: none"> <li>8x Isolated DIO (4 in/4 out), 10-Pin Terminal Block</li> </ul>
<b>Storage</b>	
SSD/HDD	<ul style="list-style-type: none"> <li>1x 2.5" Front Accessible SATA HDD/SSD Bay</li> </ul>
M.2 SSD	<ul style="list-style-type: none"> <li>1 x M.2 SSD Shared by M.2 Key B Socket</li> </ul>
<b>Expansion</b>	
M.2 Key B Socket	<ul style="list-style-type: none"> <li>1x M.2 Key B Type 3042/3052 Socket for 5G/Storage/Add-on Card Expansion</li> </ul>
M.2 Key E Socket	<ul style="list-style-type: none"> <li>1x M.2 Key E Type 2230 Socket for Wireless/Intel CNVi Module Expansion</li> </ul>
SIM Socket	<ul style="list-style-type: none"> <li>1x Front Accessible SIM Socket</li> </ul>
CFM (Control Function Module) Interface	<ul style="list-style-type: none"> <li>1x CFM Interface for optional IGN Module Expansion</li> <li>1x CFM Interface for optional PoE Module Expansion</li> </ul>
<b>Other Function</b>	
Clear CMOS Switch	<ul style="list-style-type: none"> <li>1x Clear CMOS Switch</li> </ul>
Reset Button	<ul style="list-style-type: none"> <li>1x Reset Button</li> </ul>



Instant Reboot	<ul style="list-style-type: none"> <li>Support 0.2sec Instant Reboot Technology</li> </ul>
Watchdog Timer	<ul style="list-style-type: none"> <li>Software Programmable Supports 256 Levels System Reset</li> </ul>
OSD Button	<ul style="list-style-type: none"> <li>LCD On/Off, Brightness Up, Brightness Down</li> </ul>
Internal Speaker	<ul style="list-style-type: none"> <li>AMP 2W + 2W</li> </ul>
Status LED Indicator	<ul style="list-style-type: none"> <li>Power LED, HDD LED</li> </ul>
<b>Power</b>	
Power Button	<ul style="list-style-type: none"> <li>1x ATX Power On/Off Button</li> </ul>
Power Mode Switch	<ul style="list-style-type: none"> <li>1x AT/ATX Mode Switch</li> </ul>
Power Input	<ul style="list-style-type: none"> <li>9-48VDC, 3-pin Terminal Block</li> </ul>
Remote Power On/Off	<ul style="list-style-type: none"> <li>1x Remote Power On/Off, 2-pin Terminal Block</li> </ul>
Remote Power LED	<ul style="list-style-type: none"> <li>1x Remote Power LED, 2-pin Terminal Block</li> </ul>
<b>Operating System</b>	
Windows	<ul style="list-style-type: none"> <li>Windows®11, Windows®10</li> </ul>
Linux	<ul style="list-style-type: none"> <li>Ubuntu 22.04</li> </ul>
<b>Physical</b>	
Dimension (W x D x H)	<ul style="list-style-type: none"> <li>204.5 x 149 x 46.5 mm</li> </ul>
Weight Information	<ul style="list-style-type: none"> <li>1.57 KG</li> </ul>
Mechanical Construction	<ul style="list-style-type: none"> <li>Extruded Aluminum with Heavy Duty Metal</li> </ul>
Mounting	<ul style="list-style-type: none"> <li>Wall/ VESA/ CDS/ DIN Rail</li> </ul>
Physical Design	<ul style="list-style-type: none"> <li>Fanless Design</li> <li>Jumper-less Design</li> </ul>
<b>Reliability &amp; Protection</b>	
Reverse Power Input Protection	<ul style="list-style-type: none"> <li>Yes</li> </ul>
Over Voltage Protection	<ul style="list-style-type: none"> <li>Protection Range: 51-58V</li> <li>Protection Type: shut down operating voltage, re-power on at the present level to recover</li> </ul>
Over Current Protection	<ul style="list-style-type: none"> <li>15A</li> </ul>
CMOS Battery Backup	<ul style="list-style-type: none"> <li>SuperCap Integrated for CMOS Battery Maintenance-free Operation</li> </ul>
MTBF	<ul style="list-style-type: none"> <li>306,338 Hours - Database: Telcordia SR-332 Issue3, Method 1, Case 3</li> </ul>
<b>Environment</b>	
Operating Temperature	<ul style="list-style-type: none"> <li>-40°C to 70°C</li> <li>* PassMark BurnInTest: 100% CPU, 2D/3D Graphics (without thermal throttling)</li> <li>* With extended temperature peripherals; Ambient with air flow</li> <li>* According to IEC60068-2-1, IEC60068-2-2, IEC60068-2-14</li> </ul>
Storage Temperature	<ul style="list-style-type: none"> <li>-40°C to 70°C</li> </ul>
Relative Humidity	<ul style="list-style-type: none"> <li>95%RH @ 70°C (non-Condensing)</li> </ul>
Shock	<ul style="list-style-type: none"> <li>Operating, 50 Grms, Half-sine 11 ms Duration (w/ SSD, according to IEC60068-2-27)</li> </ul>
Vibration	<ul style="list-style-type: none"> <li>Operating, 1 Grms, 10-500 Hz, 3 Axes (w/ SSD, according to IEC60068-2-6)</li> <li>Operating, 5 Grms, 5-500 Hz, 3 Axes (w/ SSD, according to IEC60068-2-64)</li> </ul>
EMC	<ul style="list-style-type: none"> <li>CE, UKCA, FCC, ICES-003 Class A</li> </ul>

	<ul style="list-style-type: none"> <li>• EN61000-6-4, EN61000-6-2 @ DC-input 24V</li> </ul>
EMI	<ul style="list-style-type: none"> <li>• CISPR 32 Conducted &amp; Radiated: Class A</li> <li>• EN/BS EN 55032 Conducted &amp; Radiated: Class A</li> <li>• EN/BS EN IEC 61000-3-2 Harmonic current emissions: Class A</li> <li>• EN/BS EN61000-3-3 Voltage fluctuations &amp; flicker</li> <li>• FCC 47 CFR Part 15B, ICES-003 Conducted &amp; Radiated: Class A</li> </ul>
EMS	<ul style="list-style-type: none"> <li>• EN/IEC 61000-4-2 ESD: Contact: 4 kV; Air: 8 kV</li> <li>• EN/IEC 61000-4-3 RS: 80 MHz to 1000 MHz: 10 V/m</li> <li>• EN/IEC 61000-4-4 EFT: AC Power: 2 kV; DC Power: 1 kV; Signal: 1 kV</li> <li>• EN/IEC 61000-4-5 Surges: AC Power: 2 kV; Signal: 1 kV</li> <li>• EN/IEC 61000-4-6 CS: 10V</li> </ul> <p>(*Compliant with the standard when utilizing shielded ethernet cable.)</p> <ul style="list-style-type: none"> <li>• EN/IEC 61000-4-8 PFMF: 50 Hz, 30A/m</li> <li>• EN/IEC 61000-4-11 Voltage Dips &amp; Voltage Interruptions: 1 cycles at 60 Hz</li> </ul>
Safety	<ul style="list-style-type: none"> <li>• UL, cUL, CB, IEC, EN62368-1</li> </ul>

*\* Product Specifications and features are for reference only and are subject to change without prior notice. For more information, please refer to the latest product datasheet from Cincoze's website.*

## Dimension

CS-108C/P1301

Unit: mm

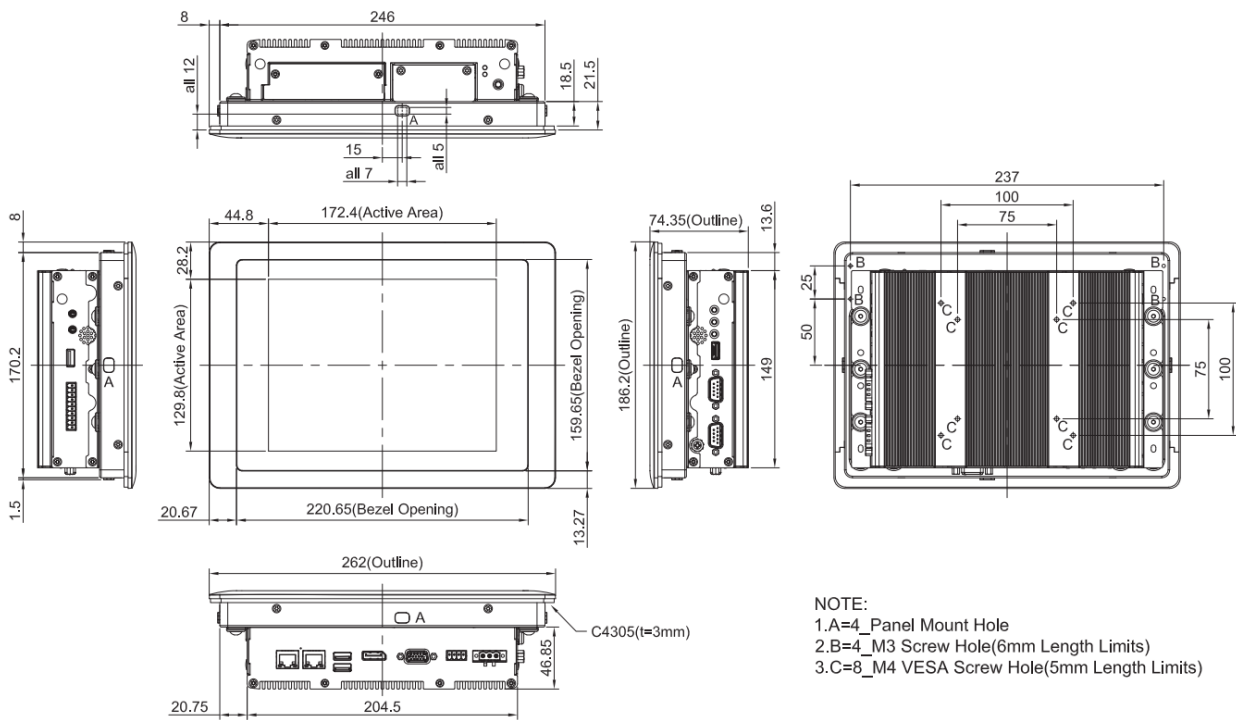

## 1.2.2 CS-110HC/P1301 Series

Model Name	CS-110HC
<b>Display</b>	
LCD Size	• 10.4" (4:3)
Max. Resolution	• 1024 x 768
Brightness (cd/m <sup>2</sup> )	• 1500
Contract Ratio	• 1400 : 1
LCD Color	• 16.2M
Pixel Pitch	• 0.206 (H) x 0.206 (V)
Viewing Angle	• 178 (H) / 178 (V)
Backlight MTBF	• 50,000 hrs(LED Backlight)
<b>Touchscreen</b>	
Touch Type	• Projected Capacitive
<b>Physical</b>	
Dimension (WxDxH)	• 295 x 227.3 x 56.2mm
Weight	• 2.24kg
Mechanical Construction	• Flat Rugged Aluminum Die-casting Bezel
<b>Environment</b>	
Front Panel Protection	• IP 65 Compliant
Operating Temperature	• Ambient with Air flow: -20°C to 70°C (extended temperature peripherals)
Storage Temperature	• -20°C to 70°C
Relative Humidity	• 80% RH @ 40°C (non-condensing)
EMC	• CE, UKCA, FCC, ICES-003 Class A
EMI	<ul style="list-style-type: none"> <li>• CISPR 32 Conducted &amp; Radiated: Class A</li> <li>• EN/BS EN 55032 Conducted &amp; Radiated: Class A</li> <li>• EN/BS EN IEC 61000-3-2 Harmonic current emissions: Class A</li> <li>• EN/BS EN61000-3-3 Voltage fluctuations &amp; flicker</li> <li>• FCC 47 CFR Part 15B, ICES-003 Conducted &amp; Radiated: Class A</li> </ul>
EMS	<ul style="list-style-type: none"> <li>• EN/IEC 61000-4-2 ESD: Contact: 4 kV; Air: 8 kV</li> <li>• EN/IEC 61000-4-3 RS: 80 MHz to 1000 MHz: 3 V/m</li> <li>• EN/IEC 61000-4-4 EFT: AC Power: 1 kV; DC Power: 0.5 kV; Signal: 0.5 kV</li> <li>• EN/IEC 61000-4-5 Surges: AC Power: 2 kV; Signal: 1 kV</li> <li>• EN/IEC 61000-4-6 CS: 3V</li> <li>• EN/IEC 61000-4-8 PFMF: 50 Hz, 1A/m</li> <li>• EN/IEC 61000-4-11 Voltage Dips &amp; Voltage Interruptions: 0.5 cycles at 50 Hz</li> </ul>
Safety	• UL, cUL, CB, IEC, EN 62368-1

Model Name	P1301
<b>System</b>	
Processor	<ul style="list-style-type: none"> <li>Onboard Intel® Alder Lake-N Series Processor:               <ul style="list-style-type: none"> <li>Intel® Processor N97 4 Cores Up to 3.60 GHz, TDP 12W</li> <li>Intel Atom® x7425E 4 Cores Up to 3.40 GHz, TDP 12W</li> </ul> </li> </ul>
Memory	<ul style="list-style-type: none"> <li>1x DDR5 4800MHz SO-DIMM Socket</li> <li>Supports Un-buffered and Non-ECC Type, Up to 16GB</li> </ul>
BIOS	<ul style="list-style-type: none"> <li>AMI BIOS</li> </ul>
<b>Graphics</b>	
Graphics Engine	<ul style="list-style-type: none"> <li>Integrated Intel® UHD Graphics</li> </ul>
Maximum Display Output	<ul style="list-style-type: none"> <li>Supports Triple Independent Display</li> </ul>
CDS	<ul style="list-style-type: none"> <li>1x CDS Connector (1920 x 1080 @ 60Hz)</li> </ul>
DP	<ul style="list-style-type: none"> <li>1x DisplayPort Connector (4096 x 2304 @ 60Hz)</li> <li>* Verified maximum resolution: 3840x2160 @ 60Hz</li> </ul>
VGA	<ul style="list-style-type: none"> <li>1x VGA Connector (1920 x 1200 @60Hz)</li> </ul>
<b>Audio</b>	
Audio Codec	<ul style="list-style-type: none"> <li>Realtek® ALC888, High Definition Audio</li> </ul>
Line-out	<ul style="list-style-type: none"> <li>1x Line-out, Phone Jack 3.5mm</li> </ul>
Mic-in	<ul style="list-style-type: none"> <li>1x Mic-in, Phone Jack 3.5mm</li> </ul>
<b>I/O</b>	
LAN	<ul style="list-style-type: none"> <li>2x 2.5GbE LAN, RJ45</li> <li>- GbE1 / GbE2: Intel® I225</li> </ul>
COM	<ul style="list-style-type: none"> <li>2x RS-232/422/485 with Auto Flow Control Support 5V/12V, DB9</li> </ul>
USB	<ul style="list-style-type: none"> <li>3x 10Gbps USB 3.2 Gen2x1, Type A</li> <li>1x 480Mbps USB 2.0, Type A</li> </ul>
DIO	<ul style="list-style-type: none"> <li>8x Isolated DIO (4 in/4 out), 10-Pin Terminal Block</li> </ul>
<b>Storage</b>	
SSD/HDD	<ul style="list-style-type: none"> <li>1x 2.5" Front Accessible SATA HDD/SSD Bay</li> </ul>
M.2 SSD	<ul style="list-style-type: none"> <li>1 x M.2 SSD Shared by M.2 Key B Socket</li> </ul>
<b>Expansion</b>	
M.2 Key B Socket	<ul style="list-style-type: none"> <li>1x M.2 Key B Type 3042/3052 Socket for 5G/Storage/Add-on Card Expansion</li> </ul>
M.2 Key E Socket	<ul style="list-style-type: none"> <li>1x M.2 Key E Type 2230 Socket for Wireless/Intel CNVi Module Expansion</li> </ul>
SIM Socket	<ul style="list-style-type: none"> <li>1x Front Accessible SIM Socket</li> </ul>
CFM (Control Function Module) Interface	<ul style="list-style-type: none"> <li>1x CFM Interface for optional IGN Module Expansion</li> <li>1x CFM Interface for optional PoE Module Expansion</li> </ul>
<b>Other Function</b>	
Clear CMOS Switch	<ul style="list-style-type: none"> <li>1x Clear CMOS Switch</li> </ul>
Reset Button	<ul style="list-style-type: none"> <li>1x Reset Button</li> </ul>

Instant Reboot	• Support 0.2sec Instant Reboot Technology
Watchdog Timer	• Software Programmable Supports 256 Levels System Reset
OSD Button	• LCD On/Off, Brightness Up, Brightness Down
Internal Speaker	• AMP 2W + 2W
Status LED Indicator	• Power LED, HDD LED
<b>Power</b>	
Power Button	• 1x ATX Power On/Off Button
Power Mode Switch	• 1x AT/ATX Mode Switch
Power Input	• 9-48VDC, 3-pin Terminal Block
Remote Power On/Off	• 1x Remote Power On/Off, 2-pin Terminal Block
Remote Power LED	• 1x Remote Power LED, 2-pin Terminal Block
<b>Operating System</b>	
Windows	• Windows®11, Windows®10
Linux	• Ubuntu 22.04
<b>Physical</b>	
Dimension (W x D x H)	• 204.5 x 149 x 46.5 mm
Weight Information	• 1.57 KG
Mechanical Construction	• Extruded Aluminum with Heavy Duty Metal
Mounting	• Wall/ VESA/ CDS/ DIN Rail
Physical Design	• Fanless Design • Jumper-less Design
<b>Reliability &amp; Protection</b>	
Reverse Power Input Protection	• Yes
Over Voltage Protection	• Protection Range: 51-58V • Protection Type: shut down operating voltage, re-power on at the present level to recover
Over Current Protection	• 15A
CMOS Battery Backup	• SuperCap Integrated for CMOS Battery Maintenance-free Operation
MTBF	• 306,338 Hours - Database: Telcordia SR-332 Issue3, Method 1, Case 3
<b>Environment</b>	
Operating Temperature	• -40°C to 70°C * PassMark BurnInTest: 100% CPU, 2D/3D Graphics (without thermal throttling) * With extended temperature peripherals; Ambient with air flow * According to IEC60068-2-1, IEC60068-2-2, IEC60068-2-14
Storage Temperature	• -40°C to 70°C
Relative Humidity	• 95%RH @ 70°C (non-Condensing)
Shock	• Operating, 50 Grms, Half-sine 11 ms Duration (w/ SSD, according to IEC60068-2-27)
Vibration	• Operating, 1 Grms, 10-500 Hz, 3 Axes (w/ SSD, according to IEC60068-2-6) • Operating, 5 Grms, 5-500 Hz, 3 Axes (w/ SSD, according to IEC60068-2-64)
EMC	• CE, UKCA, FCC, ICES-003 Class A

	<ul style="list-style-type: none"> <li>• EN61000-6-4, EN61000-6-2 @ DC-input 24V</li> </ul>
EMI	<ul style="list-style-type: none"> <li>• CISPR 32 Conducted &amp; Radiated: Class A</li> <li>• EN/BS EN 55032 Conducted &amp; Radiated: Class A</li> <li>• EN/BS EN IEC 61000-3-2 Harmonic current emissions: Class A</li> <li>• EN/BS EN61000-3-3 Voltage fluctuations &amp; flicker</li> <li>• FCC 47 CFR Part 15B, ICES-003 Conducted &amp; Radiated: Class A</li> </ul>
EMS	<ul style="list-style-type: none"> <li>• EN/IEC 61000-4-2 ESD: Contact: 4 kV; Air: 8 kV</li> <li>• EN/IEC 61000-4-3 RS: 80 MHz to 1000 MHz: 10 V/m</li> <li>• EN/IEC 61000-4-4 EFT: AC Power: 2 kV; DC Power: 1 kV; Signal: 1 kV</li> <li>• EN/IEC 61000-4-5 Surges: AC Power: 2 kV; Signal: 1 kV</li> <li>• EN/IEC 61000-4-6 CS: 10V</li> </ul> <p>(*Compliant with the standard when utilizing shielded ethernet cable.)</p> <ul style="list-style-type: none"> <li>• EN/IEC 61000-4-8 PFMF: 50 Hz, 30A/m</li> <li>• EN/IEC 61000-4-11 Voltage Dips &amp; Voltage Interruptions: 1 cycles at 60 Hz</li> </ul>
Safety	<ul style="list-style-type: none"> <li>• UL, cUL, CB, IEC, EN62368-1</li> </ul>

*\* Product Specifications and features are for reference only and are subject to change without prior notice. For more information, please refer to the latest product datasheet from Cincoze's website.*

## Dimension

CS-110HC/P1301

Unit: mm

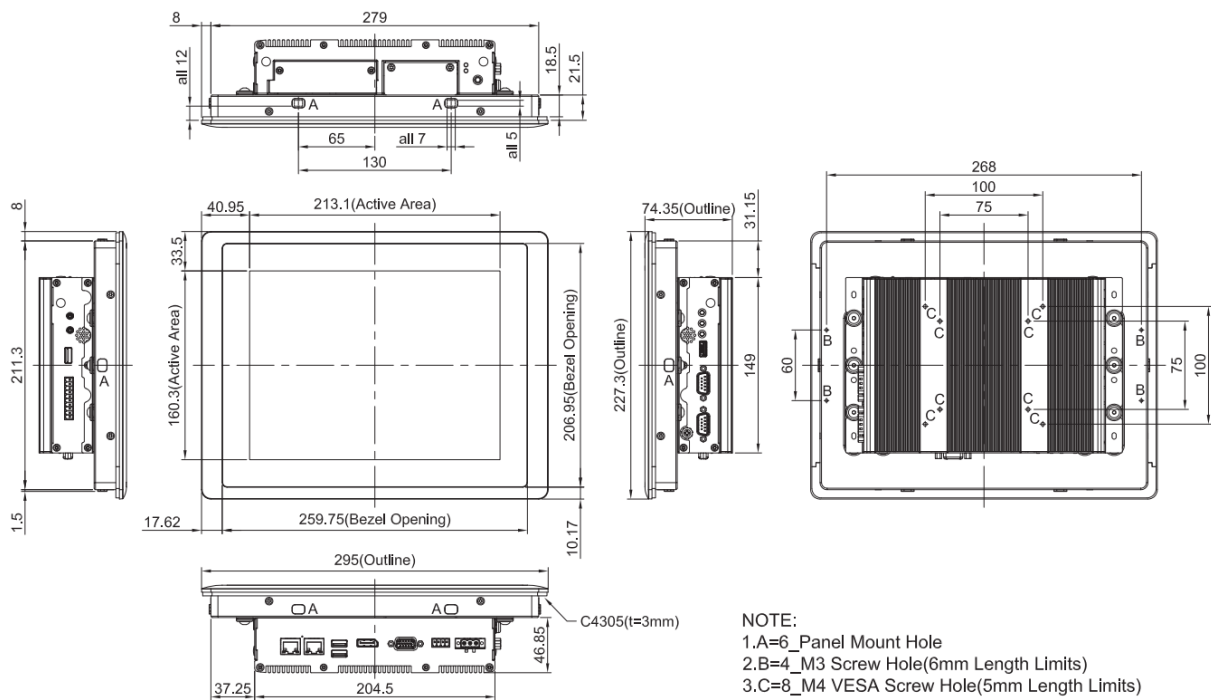

### 1.2.3 CS-112HC/P1301 Series

Model Name	CS-112HC
<b>Display</b>	
LCD Size	• 12.1" (4:3)
Max. Resolution	• 1024 x 768
Brightness (cd/m <sup>2</sup> )	• 1500
Contract Ratio	• 700 : 1
LCD Color	• 16.7M
Pixel Pitch	• 0.24 (H) x 0.24 (V)
Viewing Angle	• 160 / 160
Backlight MTBF	• 30,000 hrs (LED Backlight)
<b>Touchscreen</b>	
Touch Type	• Projected Capacitive
<b>Physical</b>	
Dimension (WxDxH)	• 345 x 265.3 x 57 mm
Weight	• 3.16 kg
Construction	• Flat Rugged Aluminum Die-casting Bezel
<b>Environment</b>	
Front Panel Protection	• IP 65 Compliant
Operating Temperature	• Ambient with Air flow: -20°C to 70°C (extended temperature peripherals)
Storage Temperature	• -20°C to 70°C
Relative Humidity	• 80% RH @ 40°C (non-condensing)
EMC	• CE, UKCA, FCC, ICES-003 Class A
EMI	<ul style="list-style-type: none"> <li>• CISPR 32 Conducted &amp; Radiated: Class A</li> <li>• EN/BS EN 55032 Conducted &amp; Radiated: Class A</li> <li>• EN/BS EN IEC 61000-3-2 Harmonic current emissions: Class A</li> <li>• EN/BS EN61000-3-3 Voltage fluctuations &amp; flicker</li> <li>• FCC 47 CFR Part 15B, ICES-003 Conducted &amp; Radiated: Class A</li> </ul>
EMS	<ul style="list-style-type: none"> <li>• EN/IEC 61000-4-2 ESD: Contact: 4 kV; Air: 8 kV</li> <li>• EN/IEC 61000-4-3 RS: 80 MHz to 1000 MHz: 3 V/m</li> <li>• EN/IEC 61000-4-4 EFT: AC Power: 1 kV; DC Power: 0.5 kV; Signal: 0.5 kV</li> <li>• EN/IEC 61000-4-5 Surges: AC Power: 2 kV; Signal: 1 kV</li> <li>• EN/IEC 61000-4-6 CS: 3V</li> <li>• EN/IEC 61000-4-8 PFMF: 50 Hz, 1A/m</li> <li>• EN/IEC 61000-4-11 Voltage Dips &amp; Voltage Interruptions: 0.5 cycles at 50 Hz</li> </ul>
Safety	• UL, cUL, CB, IEC, EN 62368-1

Model Name	P1301
<b>System</b>	
Processor	<ul style="list-style-type: none"> <li>Onboard Intel® Alder Lake-N Series Processor:               <ul style="list-style-type: none"> <li>Intel® Processor N97 4 Cores Up to 3.60 GHz, TDP 12W</li> <li>Intel Atom® x7425E 4 Cores Up to 3.40 GHz, TDP 12W</li> </ul> </li> </ul>
Memory	<ul style="list-style-type: none"> <li>1x DDR5 4800MHz SO-DIMM Socket</li> <li>Supports Un-buffered and Non-ECC Type, Up to 16GB</li> </ul>
BIOS	<ul style="list-style-type: none"> <li>AMI BIOS</li> </ul>
<b>Graphics</b>	
Graphics Engine	<ul style="list-style-type: none"> <li>Integrated Intel® UHD Graphics</li> </ul>
Maximum Display Output	<ul style="list-style-type: none"> <li>Supports Triple Independent Display</li> </ul>
CDS	<ul style="list-style-type: none"> <li>1x CDS Connector (1920 x 1080 @ 60Hz)</li> </ul>
DP	<ul style="list-style-type: none"> <li>1x DisplayPort Connector (4096 x 2304 @ 60Hz)</li> <li>* Verified maximum resolution: 3840x2160 @ 60Hz</li> </ul>
VGA	<ul style="list-style-type: none"> <li>1x VGA Connector (1920 x 1200 @60Hz)</li> </ul>
<b>Audio</b>	
Audio Codec	<ul style="list-style-type: none"> <li>Realtek® ALC888, High Definition Audio</li> </ul>
Line-out	<ul style="list-style-type: none"> <li>1x Line-out, Phone Jack 3.5mm</li> </ul>
Mic-in	<ul style="list-style-type: none"> <li>1x Mic-in, Phone Jack 3.5mm</li> </ul>
<b>I/O</b>	
LAN	<ul style="list-style-type: none"> <li>2x 2.5GbE LAN, RJ45</li> <li>- GbE1 / GbE2: Intel® I225</li> </ul>
COM	<ul style="list-style-type: none"> <li>2x RS-232/422/485 with Auto Flow Control Support 5V/12V, DB9</li> </ul>
USB	<ul style="list-style-type: none"> <li>3x 10Gbps USB 3.2 Gen2x1, Type A</li> <li>1x 480Mbps USB 2.0, Type A</li> </ul>
DIO	<ul style="list-style-type: none"> <li>8x Isolated DIO (4 in/4 out), 10-Pin Terminal Block</li> </ul>
<b>Storage</b>	
SSD/HDD	<ul style="list-style-type: none"> <li>1x 2.5" Front Accessible SATA HDD/SSD Bay</li> </ul>
M.2 SSD	<ul style="list-style-type: none"> <li>1 x M.2 SSD Shared by M.2 Key B Socket</li> </ul>
<b>Expansion</b>	
M.2 Key B Socket	<ul style="list-style-type: none"> <li>1x M.2 Key B Type 3042/3052 Socket for 5G/Storage/Add-on Card Expansion</li> </ul>
M.2 Key E Socket	<ul style="list-style-type: none"> <li>1x M.2 Key E Type 2230 Socket for Wireless/Intel CNVi Module Expansion</li> </ul>
SIM Socket	<ul style="list-style-type: none"> <li>1x Front Accessible SIM Socket</li> </ul>
CFM (Control Function Module) Interface	<ul style="list-style-type: none"> <li>1x CFM Interface for optional IGN Module Expansion</li> <li>1x CFM Interface for optional PoE Module Expansion</li> </ul>
<b>Other Function</b>	
Clear CMOS Switch	<ul style="list-style-type: none"> <li>1x Clear CMOS Switch</li> </ul>
Reset Button	<ul style="list-style-type: none"> <li>1x Reset Button</li> </ul>



Instant Reboot	<ul style="list-style-type: none"> <li>• Support 0.2sec Instant Reboot Technology</li> </ul>
Watchdog Timer	<ul style="list-style-type: none"> <li>• Software Programmable Supports 256 Levels System Reset</li> </ul>
OSD Button	<ul style="list-style-type: none"> <li>• LCD On/Off, Brightness Up, Brightness Down</li> </ul>
Internal Speaker	<ul style="list-style-type: none"> <li>• AMP 2W + 2W</li> </ul>
Status LED Indicator	<ul style="list-style-type: none"> <li>• Power LED, HDD LED</li> </ul>
<b>Power</b>	
Power Button	<ul style="list-style-type: none"> <li>• 1x ATX Power On/Off Button</li> </ul>
Power Mode Switch	<ul style="list-style-type: none"> <li>• 1x AT/ATX Mode Switch</li> </ul>
Power Input	<ul style="list-style-type: none"> <li>• 9-48VDC, 3-pin Terminal Block</li> </ul>
Remote Power On/Off	<ul style="list-style-type: none"> <li>• 1x Remote Power On/Off, 2-pin Terminal Block</li> </ul>
Remote Power LED	<ul style="list-style-type: none"> <li>• 1x Remote Power LED, 2-pin Terminal Block</li> </ul>
<b>Operating System</b>	
Windows	<ul style="list-style-type: none"> <li>• Windows®11, Windows®10</li> </ul>
Linux	<ul style="list-style-type: none"> <li>• Ubuntu 22.04</li> </ul>
<b>Physical</b>	
Dimension (W x D x H)	<ul style="list-style-type: none"> <li>• 204.5 x 149 x 46.5 mm</li> </ul>
Weight Information	<ul style="list-style-type: none"> <li>• 1.57 KG</li> </ul>
Mechanical Construction	<ul style="list-style-type: none"> <li>• Extruded Aluminum with Heavy Duty Metal</li> </ul>
Mounting	<ul style="list-style-type: none"> <li>• Wall/ VESA/ CDS/ DIN Rail</li> </ul>
Physical Design	<ul style="list-style-type: none"> <li>• Fanless Design</li> <li>• Jumper-less Design</li> </ul>
<b>Reliability &amp; Protection</b>	
Reverse Power Input Protection	<ul style="list-style-type: none"> <li>• Yes</li> </ul>
Over Voltage Protection	<ul style="list-style-type: none"> <li>• Protection Range: 51-58V</li> <li>• Protection Type: shut down operating voltage, re-power on at the present level to recover</li> </ul>
Over Current Protection	<ul style="list-style-type: none"> <li>• 15A</li> </ul>
CMOS Battery Backup	<ul style="list-style-type: none"> <li>• SuperCap Integrated for CMOS Battery Maintenance-free Operation</li> </ul>
MTBF	<ul style="list-style-type: none"> <li>• 306,338 Hours - Database: Telcordia SR-332 Issue3, Method 1, Case 3</li> </ul>
<b>Environment</b>	
Operating Temperature	<ul style="list-style-type: none"> <li>• -40°C to 70°C</li> <li>* PassMark BurnInTest: 100% CPU, 2D/3D Graphics (without thermal throttling)</li> <li>* With extended temperature peripherals; Ambient with air flow</li> <li>* According to IEC60068-2-1, IEC60068-2-2, IEC60068-2-14</li> </ul>
Storage Temperature	<ul style="list-style-type: none"> <li>• -40°C to 70°C</li> </ul>
Relative Humidity	<ul style="list-style-type: none"> <li>• 95%RH @ 70°C (non-Condensing)</li> </ul>
Shock	<ul style="list-style-type: none"> <li>• Operating, 50 Grms, Half-sine 11 ms Duration (w/ SSD, according to IEC60068-2-27)</li> </ul>
Vibration	<ul style="list-style-type: none"> <li>• Operating, 1 Grms, 10-500 Hz, 3 Axes (w/ SSD, according to IEC60068-2-6)</li> <li>• Operating, 5 Grms, 5-500 Hz, 3 Axes (w/ SSD, according to IEC60068-2-64)</li> </ul>
EMC	<ul style="list-style-type: none"> <li>• CE, UKCA, FCC, ICES-003 Class A</li> </ul>

	<ul style="list-style-type: none"> <li>• EN61000-6-4, EN61000-6-2 @ DC-input 24V</li> </ul>
EMI	<ul style="list-style-type: none"> <li>• CISPR 32 Conducted &amp; Radiated: Class A</li> <li>• EN/BS EN 55032 Conducted &amp; Radiated: Class A</li> <li>• EN/BS EN IEC 61000-3-2 Harmonic current emissions: Class A</li> <li>• EN/BS EN61000-3-3 Voltage fluctuations &amp; flicker</li> <li>• FCC 47 CFR Part 15B, ICES-003 Conducted &amp; Radiated: Class A</li> </ul>
EMS	<ul style="list-style-type: none"> <li>• EN/IEC 61000-4-2 ESD: Contact: 4 kV; Air: 8 kV</li> <li>• EN/IEC 61000-4-3 RS: 80 MHz to 1000 MHz: 10 V/m</li> <li>• EN/IEC 61000-4-4 EFT: AC Power: 2 kV; DC Power: 1 kV; Signal: 1 kV</li> <li>• EN/IEC 61000-4-5 Surges: AC Power: 2 kV; Signal: 1 kV</li> <li>• EN/IEC 61000-4-6 CS: 10V</li> <li>(**Compliant with the standard when utilizing shielded ethernet cable.)</li> <li>• EN/IEC 61000-4-8 PFMF: 50 Hz, 30A/m</li> <li>• EN/IEC 61000-4-11 Voltage Dips &amp; Voltage Interruptions: 1 cycles at 60 Hz</li> </ul>
Safety	<ul style="list-style-type: none"> <li>• UL, cUL, CB, IEC, EN62368-1</li> </ul>

*\* Product Specifications and features are for reference only and are subject to change without prior notice. For more information, please refer to the latest product datasheet from Cincoze's website.*

## Dimensions

CV-112H/P1301

unit: mm

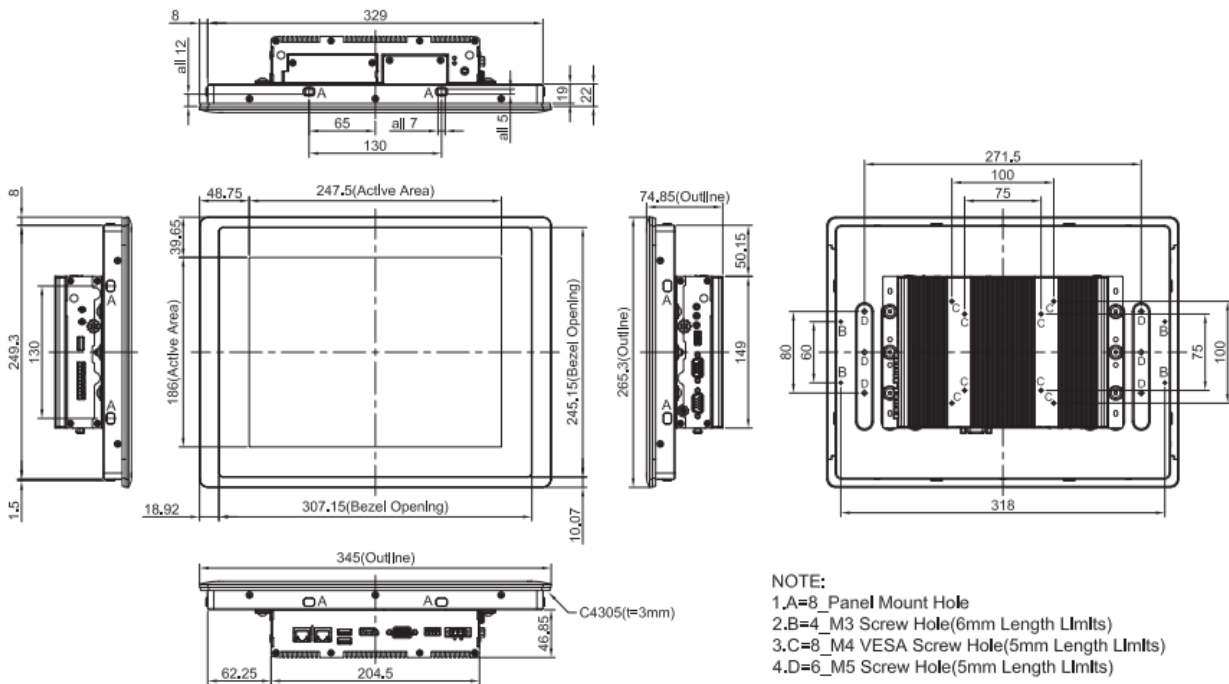

## 1.2.4 CS-115C/P1301 Series

Model Name	CS-115C
<b>Display</b>	
LCD Size	• 15" (4:3)
Max. Resolution	• 1024 x 768
Brightness (cd/m <sup>2</sup> )	• 1800
Contract Ratio	• 800 : 1
LCD Color	• 16.2M
Pixel Pitch	• 0.297 (H) x 0.297(V)
Viewing Angle	• 160 / 150
Backlight MTBF	• 50,000 hrs (LED Backlight)
<b>Touchscreen</b>	
Touchscreen Type	• Projected Capacitive Touch
<b>Physical</b>	
Dimension (WxDxH)	• 408 x 312.4 x 59.2 mm
Weight	• 4.36kg
Construction	• Flat Rugged Aluminum Die-casting Bezel
<b>Environment</b>	
Front Panel Protection	• IP 65 Compliant
Operating Temperature	• Ambient with Air flow: -20°C to 70°C (extended temperature peripherals)
Storage Temperature	• -20°C to 70°C
Relative Humidity	• 80% RH @ 40°C (non-condensing)
EMC	• CE, UKCA, FCC, ICES-003 Class A
EMI	<ul style="list-style-type: none"> <li>• CISPR 32 Conducted &amp; Radiated: Class A</li> <li>• EN/BS EN 55032 Conducted &amp; Radiated: Class A</li> <li>• EN/BS EN IEC 61000-3-2 Harmonic current emissions: Class A</li> <li>• EN/BS EN61000-3-3 Voltage fluctuations &amp; flicker</li> <li>• FCC 47 CFR Part 15B, ICES-003 Conducted &amp; Radiated: Class A</li> </ul>
EMS	<ul style="list-style-type: none"> <li>• EN/IEC 61000-4-2 ESD: Contact: 4 kV; Air: 8 kV</li> <li>• EN/IEC 61000-4-3 RS: 80 MHz to 1000 MHz: 3 V/m</li> <li>• EN/IEC 61000-4-4 EFT: AC Power: 1 kV; DC Power: 0.5 kV; Signal: 0.5 kV</li> <li>• EN/IEC 61000-4-5 Surges: AC Power: 2 kV; Signal: 1 kV</li> <li>• EN/IEC 61000-4-6 CS: 3V</li> <li>• EN/IEC 61000-4-8 PFMF: 50 Hz, 1A/m</li> <li>• EN/IEC 61000-4-11 Voltage Dips &amp; Voltage Interruptions: 0.5 cycles at 50 Hz</li> </ul>
Safety	• UL, cUL, CB, IEC, EN 62368-1

Model Name	P1301
<b>System</b>	
Processor	<ul style="list-style-type: none"> <li>Onboard Intel® Alder Lake-N Series Processor:               <ul style="list-style-type: none"> <li>Intel® Processor N97 4 Cores Up to 3.60 GHz, TDP 12W</li> <li>Intel Atom® x7425E 4 Cores Up to 3.40 GHz, TDP 12W</li> </ul> </li> </ul>
Memory	<ul style="list-style-type: none"> <li>1x DDR5 4800MHz SO-DIMM Socket</li> <li>Supports Un-buffered and Non-ECC Type, Up to 16GB</li> </ul>
BIOS	<ul style="list-style-type: none"> <li>AMI BIOS</li> </ul>
<b>Graphics</b>	
Graphics Engine	<ul style="list-style-type: none"> <li>Integrated Intel® UHD Graphics</li> </ul>
Maximum Display Output	<ul style="list-style-type: none"> <li>Supports Triple Independent Display</li> </ul>
CDS	<ul style="list-style-type: none"> <li>1x CDS Connector (1920 x 1080 @ 60Hz)</li> </ul>
DP	<ul style="list-style-type: none"> <li>1x DisplayPort Connector (4096 x 2304 @ 60Hz)</li> <li>* Verified maximum resolution: 3840x2160 @ 60Hz</li> </ul>
VGA	<ul style="list-style-type: none"> <li>1x VGA Connector (1920 x 1200 @60Hz)</li> </ul>
<b>Audio</b>	
Audio Codec	<ul style="list-style-type: none"> <li>Realtek® ALC888, High Definition Audio</li> </ul>
Line-out	<ul style="list-style-type: none"> <li>1x Line-out, Phone Jack 3.5mm</li> </ul>
Mic-in	<ul style="list-style-type: none"> <li>1x Mic-in, Phone Jack 3.5mm</li> </ul>
<b>I/O</b>	
LAN	<ul style="list-style-type: none"> <li>2x 2.5GbE LAN, RJ45</li> <li>- GbE1 / GbE2: Intel® I225</li> </ul>
COM	<ul style="list-style-type: none"> <li>2x RS-232/422/485 with Auto Flow Control Support 5V/12V, DB9</li> </ul>
USB	<ul style="list-style-type: none"> <li>3x 10Gbps USB 3.2 Gen2x1, Type A</li> <li>1x 480Mbps USB 2.0, Type A</li> </ul>
DIO	<ul style="list-style-type: none"> <li>8x Isolated DIO (4 in/4 out), 10-Pin Terminal Block</li> </ul>
<b>Storage</b>	
SSD/HDD	<ul style="list-style-type: none"> <li>1x 2.5" Front Accessible SATA HDD/SSD Bay</li> </ul>
M.2 SSD	<ul style="list-style-type: none"> <li>1 x M.2 SSD Shared by M.2 Key B Socket</li> </ul>
<b>Expansion</b>	
M.2 Key B Socket	<ul style="list-style-type: none"> <li>1x M.2 Key B Type 3042/3052 Socket for 5G/Storage/Add-on Card Expansion</li> </ul>
M.2 Key E Socket	<ul style="list-style-type: none"> <li>1x M.2 Key E Type 2230 Socket for Wireless/Intel CNVi Module Expansion</li> </ul>
SIM Socket	<ul style="list-style-type: none"> <li>1x Front Accessible SIM Socket</li> </ul>
CFM (Control Function Module) Interface	<ul style="list-style-type: none"> <li>1x CFM Interface for optional IGN Module Expansion</li> <li>1x CFM Interface for optional PoE Module Expansion</li> </ul>
<b>Other Function</b>	
Clear CMOS Switch	<ul style="list-style-type: none"> <li>1x Clear CMOS Switch</li> </ul>
Reset Button	<ul style="list-style-type: none"> <li>1x Reset Button</li> </ul>

Instant Reboot	• Support 0.2sec Instant Reboot Technology
Watchdog Timer	• Software Programmable Supports 256 Levels System Reset
OSD Button	• LCD On/Off, Brightness Up, Brightness Down
Internal Speaker	• AMP 2W + 2W
Status LED Indicator	• Power LED, HDD LED
<b>Power</b>	
Power Button	• 1x ATX Power On/Off Button
Power Mode Switch	• 1x AT/ATX Mode Switch
Power Input	• 9-48VDC, 3-pin Terminal Block
Remote Power On/Off	• 1x Remote Power On/Off, 2-pin Terminal Block
Remote Power LED	• 1x Remote Power LED, 2-pin Terminal Block
<b>Operating System</b>	
Windows	• Windows®11, Windows®10
Linux	• Ubuntu 22.04
<b>Physical</b>	
Dimension (W x D x H)	• 204.5 x 149 x 46.5 mm
Weight Information	• 1.57 KG
Mechanical Construction	• Extruded Aluminum with Heavy Duty Metal
Mounting	• Wall/ VESA/ CDS/ DIN Rail
Physical Design	• Fanless Design • Jumper-less Design
<b>Reliability &amp; Protection</b>	
Reverse Power Input Protection	• Yes
Over Voltage Protection	• Protection Range: 51-58V • Protection Type: shut down operating voltage, re-power on at the present level to recover
Over Current Protection	• 15A
CMOS Battery Backup	• SuperCap Integrated for CMOS Battery Maintenance-free Operation
MTBF	• 306,338 Hours - Database: Telcordia SR-332 Issue3, Method 1, Case 3
<b>Environment</b>	
Operating Temperature	• -40°C to 70°C * PassMark BurnInTest: 100% CPU, 2D/3D Graphics (without thermal throttling) * With extended temperature peripherals; Ambient with air flow * According to IEC60068-2-1, IEC60068-2-2, IEC60068-2-14
Storage Temperature	• -40°C to 70°C
Relative Humidity	• 95%RH @ 70°C (non-Condensing)
Shock	• Operating, 50 Grms, Half-sine 11 ms Duration (w/ SSD, according to IEC60068-2-27)
Vibration	• Operating, 1 Grms, 10-500 Hz, 3 Axes (w/ SSD, according to IEC60068-2-6) • Operating, 5 Grms, 5-500 Hz, 3 Axes (w/ SSD, according to IEC60068-2-64)
EMC	• CE, UKCA, FCC, ICES-003 Class A

	<ul style="list-style-type: none"> <li>EN61000-6-4, EN61000-6-2 @ DC-input 24V</li> </ul>
EMI	<ul style="list-style-type: none"> <li>CISPR 32 Conducted &amp; Radiated: Class A</li> <li>EN/BS EN 55032 Conducted &amp; Radiated: Class A</li> <li>EN/BS EN IEC 61000-3-2 Harmonic current emissions: Class A</li> <li>EN/BS EN61000-3-3 Voltage fluctuations &amp; flicker</li> <li>FCC 47 CFR Part 15B, ICES-003 Conducted &amp; Radiated: Class A</li> </ul>
EMS	<ul style="list-style-type: none"> <li>EN/IEC 61000-4-2 ESD: Contact: 4 kV; Air: 8 kV</li> <li>EN/IEC 61000-4-3 RS: 80 MHz to 1000 MHz: 10 V/m</li> <li>EN/IEC 61000-4-4 EFT: AC Power: 2 kV; DC Power: 1 kV; Signal: 1 kV</li> <li>EN/IEC 61000-4-5 Surges: AC Power: 2 kV; Signal: 1 kV</li> <li>EN/IEC 61000-4-6 CS: 10V</li> <li>(**Compliant with the standard when utilizing shielded ethernet cable.)</li> <li>EN/IEC 61000-4-8 PFMF: 50 Hz, 30A/m</li> <li>EN/IEC 61000-4-11 Voltage Dips &amp; Voltage Interruptions: 1 cycles at 60 Hz</li> </ul>
Safety	<ul style="list-style-type: none"> <li>UL, cUL, CB, IEC, EN62368-1</li> </ul>

*\* Product Specifications and features are for reference only and are subject to change without prior notice. For more information, please refer to the latest product datasheet from Cincoze's website.*

## Dimensions

CS-115C/P1301

unit: mm

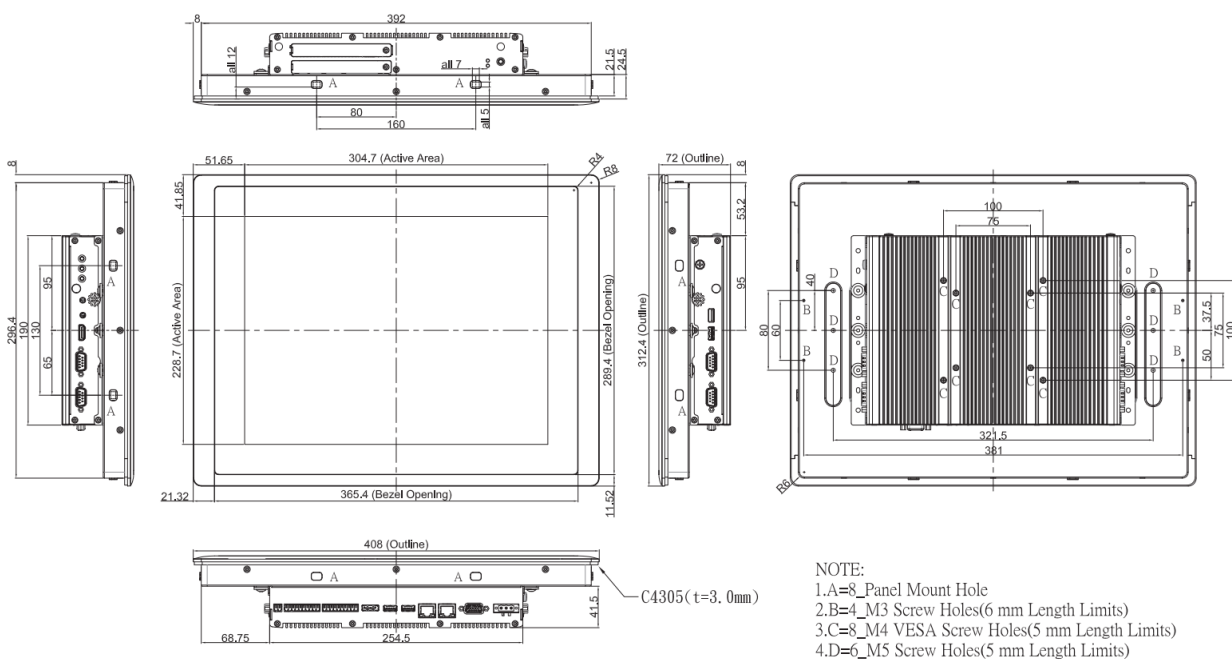

## 1.2.5 CS-117C/P1301 Series

Model Name	CS-117C
<b>Display</b>	
LCD Size	• 17" (5:4)
Max. Resolution	• 1280 x 1024
Brightness (cd/m2)	• 1500
Contract Ratio	• 800 : 1
LCD Color	• 16.7M
Pixel Pitch	• 0.264 (H) x 0.264 (V)
Viewing Angle	• 160 / 140
Backlight MTBF	• 50,000 hrs (LED Backlight)
<b>Touchscreen</b>	
Touchscreen Type	• Projected Capacitive Touch
<b>Physical</b>	
Dimension (WxDxH)	• 450 x 350 x 63.2mm
Weight	• 5.64 kg
Construction	• Flat Rugged Aluminum Die-casting Bezel
<b>Environment</b>	
Front Panel Protection	• IP 65 Compliant
Operating Temperature	• Ambient with Air flow: -20°C to 70°C (extended temperature peripherals)
Storage Temperature	• -20°C to 70°C
Relative Humidity	• 80% RH @ 40°C (non-condensing)
EMC	• CE, UKCA, FCC, ICES-003 Class A
EMI	<ul style="list-style-type: none"> <li>• CISPR 32 Conducted &amp; Radiated: Class A</li> <li>• EN/BS EN 55032 Conducted &amp; Radiated: Class A</li> <li>• EN/BS EN IEC 61000-3-2 Harmonic current emissions: Class A</li> <li>• EN/BS EN61000-3-3 Voltage fluctuations &amp; flicker</li> <li>• FCC 47 CFR Part 15B, ICES-003 Conducted &amp; Radiated: Class A</li> </ul>
EMS	<ul style="list-style-type: none"> <li>• EN/IEC 61000-4-2 ESD: Contact: 4 kV; Air: 8 kV</li> <li>• EN/IEC 61000-4-3 RS: 80 MHz to 1000 MHz: 3 V/m</li> <li>• EN/IEC 61000-4-4 EFT: AC Power: 1 kV; DC Power: 0.5 kV; Signal: 0.5 kV</li> <li>• EN/IEC 61000-4-5 Surges: AC Power: 2 kV; Signal: 1 kV</li> <li>• EN/IEC 61000-4-6 CS: 3V</li> <li>• EN/IEC 61000-4-8 PFMF: 50 Hz, 1A/m</li> <li>• EN/IEC 61000-4-11 Voltage Dips &amp; Voltage Interruptions: 0.5 cycles at 50 Hz</li> </ul>
Safety	• UL, cUL, CB, IEC, EN 62368-1

Model Name	P1301
<b>System</b>	
Processor	<ul style="list-style-type: none"> <li>Onboard Intel® Alder Lake-N Series Processor:               <ul style="list-style-type: none"> <li>Intel® Processor N97 4 Cores Up to 3.60 GHz, TDP 12W</li> <li>Intel Atom® x7425E 4 Cores Up to 3.40 GHz, TDP 12W</li> </ul> </li> </ul>
Memory	<ul style="list-style-type: none"> <li>1x DDR5 4800MHz SO-DIMM Socket</li> <li>Supports Un-buffered and Non-ECC Type, Up to 16GB</li> </ul>
BIOS	<ul style="list-style-type: none"> <li>AMI BIOS</li> </ul>
<b>Graphics</b>	
Graphics Engine	<ul style="list-style-type: none"> <li>Integrated Intel® UHD Graphics</li> </ul>
Maximum Display Output	<ul style="list-style-type: none"> <li>Supports Triple Independent Display</li> </ul>
CDS	<ul style="list-style-type: none"> <li>1x CDS Connector (1920 x 1080 @ 60Hz)</li> </ul>
DP	<ul style="list-style-type: none"> <li>1x DisplayPort Connector (4096 x 2304 @ 60Hz)</li> <li>* Verified maximum resolution: 3840x2160 @ 60Hz</li> </ul>
VGA	<ul style="list-style-type: none"> <li>1x VGA Connector (1920 x 1200 @60Hz)</li> </ul>
<b>Audio</b>	
Audio Codec	<ul style="list-style-type: none"> <li>Realtek® ALC888, High Definition Audio</li> </ul>
Line-out	<ul style="list-style-type: none"> <li>1x Line-out, Phone Jack 3.5mm</li> </ul>
Mic-in	<ul style="list-style-type: none"> <li>1x Mic-in, Phone Jack 3.5mm</li> </ul>
<b>I/O</b>	
LAN	<ul style="list-style-type: none"> <li>2x 2.5GbE LAN, RJ45</li> <li>- GbE1 / GbE2: Intel® I225</li> </ul>
COM	<ul style="list-style-type: none"> <li>2x RS-232/422/485 with Auto Flow Control Support 5V/12V, DB9</li> </ul>
USB	<ul style="list-style-type: none"> <li>3x 10Gbps USB 3.2 Gen2x1, Type A</li> <li>1x 480Mbps USB 2.0, Type A</li> </ul>
DIO	<ul style="list-style-type: none"> <li>8x Isolated DIO (4 in/4 out), 10-Pin Terminal Block</li> </ul>
<b>Storage</b>	
SSD/HDD	<ul style="list-style-type: none"> <li>1x 2.5" Front Accessible SATA HDD/SSD Bay</li> </ul>
M.2 SSD	<ul style="list-style-type: none"> <li>1 x M.2 SSD Shared by M.2 Key B Socket</li> </ul>
<b>Expansion</b>	
M.2 Key B Socket	<ul style="list-style-type: none"> <li>1x M.2 Key B Type 3042/3052 Socket for 5G/Storage/Add-on Card Expansion</li> </ul>
M.2 Key E Socket	<ul style="list-style-type: none"> <li>1x M.2 Key E Type 2230 Socket for Wireless/Intel CNVi Module Expansion</li> </ul>
SIM Socket	<ul style="list-style-type: none"> <li>1x Front Accessible SIM Socket</li> </ul>
CFM (Control Function Module) Interface	<ul style="list-style-type: none"> <li>1x CFM Interface for optional IGN Module Expansion</li> <li>1x CFM Interface for optional PoE Module Expansion</li> </ul>
<b>Other Function</b>	
Clear CMOS Switch	<ul style="list-style-type: none"> <li>1x Clear CMOS Switch</li> </ul>
Reset Button	<ul style="list-style-type: none"> <li>1x Reset Button</li> </ul>



Instant Reboot	<ul style="list-style-type: none"> <li>• Support 0.2sec Instant Reboot Technology</li> </ul>
Watchdog Timer	<ul style="list-style-type: none"> <li>• Software Programmable Supports 256 Levels System Reset</li> </ul>
OSD Button	<ul style="list-style-type: none"> <li>• LCD On/Off, Brightness Up, Brightness Down</li> </ul>
Internal Speaker	<ul style="list-style-type: none"> <li>• AMP 2W + 2W</li> </ul>
Status LED Indicator	<ul style="list-style-type: none"> <li>• Power LED, HDD LED</li> </ul>
<b>Power</b>	
Power Button	<ul style="list-style-type: none"> <li>• 1x ATX Power On/Off Button</li> </ul>
Power Mode Switch	<ul style="list-style-type: none"> <li>• 1x AT/ATX Mode Switch</li> </ul>
Power Input	<ul style="list-style-type: none"> <li>• 9-48VDC, 3-pin Terminal Block</li> </ul>
Remote Power On/Off	<ul style="list-style-type: none"> <li>• 1x Remote Power On/Off, 2-pin Terminal Block</li> </ul>
Remote Power LED	<ul style="list-style-type: none"> <li>• 1x Remote Power LED, 2-pin Terminal Block</li> </ul>
<b>Operating System</b>	
Windows	<ul style="list-style-type: none"> <li>• Windows®11, Windows®10</li> </ul>
Linux	<ul style="list-style-type: none"> <li>• Ubuntu 22.04</li> </ul>
<b>Physical</b>	
Dimension (W x D x H)	<ul style="list-style-type: none"> <li>• 204.5 x 149 x 46.5 mm</li> </ul>
Weight Information	<ul style="list-style-type: none"> <li>• 1.57 KG</li> </ul>
Mechanical Construction	<ul style="list-style-type: none"> <li>• Extruded Aluminum with Heavy Duty Metal</li> </ul>
Mounting	<ul style="list-style-type: none"> <li>• Wall/ VESA/ CDS/ DIN Rail</li> </ul>
Physical Design	<ul style="list-style-type: none"> <li>• Fanless Design</li> <li>• Jumper-less Design</li> </ul>
<b>Reliability &amp; Protection</b>	
Reverse Power Input Protection	<ul style="list-style-type: none"> <li>• Yes</li> </ul>
Over Voltage Protection	<ul style="list-style-type: none"> <li>• Protection Range: 51-58V</li> <li>• Protection Type: shut down operating voltage, re-power on at the present level to recover</li> </ul>
Over Current Protection	<ul style="list-style-type: none"> <li>• 15A</li> </ul>
CMOS Battery Backup	<ul style="list-style-type: none"> <li>• SuperCap Integrated for CMOS Battery Maintenance-free Operation</li> </ul>
MTBF	<ul style="list-style-type: none"> <li>• 306,338 Hours - Database: Telcordia SR-332 Issue3, Method 1, Case 3</li> </ul>
<b>Environment</b>	
Operating Temperature	<ul style="list-style-type: none"> <li>• -40°C to 70°C</li> <li>* PassMark BurnInTest: 100% CPU, 2D/3D Graphics (without thermal throttling)</li> <li>* With extended temperature peripherals; Ambient with air flow</li> <li>* According to IEC60068-2-1, IEC60068-2-2, IEC60068-2-14</li> </ul>
Storage Temperature	<ul style="list-style-type: none"> <li>• -40°C to 70°C</li> </ul>
Relative Humidity	<ul style="list-style-type: none"> <li>• 95%RH @ 70°C (non-Condensing)</li> </ul>
Shock	<ul style="list-style-type: none"> <li>• Operating, 50 Grms, Half-sine 11 ms Duration (w/ SSD, according to IEC60068-2-27)</li> </ul>
Vibration	<ul style="list-style-type: none"> <li>• Operating, 1 Grms, 10-500 Hz, 3 Axes (w/ SSD, according to IEC60068-2-6)</li> <li>• Operating, 5 Grms, 5-500 Hz, 3 Axes (w/ SSD, according to IEC60068-2-64)</li> </ul>
EMC	<ul style="list-style-type: none"> <li>• CE, UKCA, FCC, ICES-003 Class A</li> </ul>

	<ul style="list-style-type: none"> <li>EN61000-6-4, EN61000-6-2 @ DC-input 24V</li> </ul>
EMI	<ul style="list-style-type: none"> <li>CISPR 32 Conducted &amp; Radiated: Class A</li> <li>EN/BS EN 55032 Conducted &amp; Radiated: Class A</li> <li>EN/BS EN IEC 61000-3-2 Harmonic current emissions: Class A</li> <li>EN/BS EN61000-3-3 Voltage fluctuations &amp; flicker</li> <li>FCC 47 CFR Part 15B, ICES-003 Conducted &amp; Radiated: Class A</li> </ul>
EMS	<ul style="list-style-type: none"> <li>EN/IEC 61000-4-2 ESD: Contact: 4 kV; Air: 8 kV</li> <li>EN/IEC 61000-4-3 RS: 80 MHz to 1000 MHz: 10 V/m</li> <li>EN/IEC 61000-4-4 EFT: AC Power: 2 kV; DC Power: 1 kV; Signal: 1 kV</li> <li>EN/IEC 61000-4-5 Surges: AC Power: 2 kV; Signal: 1 kV</li> <li>EN/IEC 61000-4-6 CS: 10V</li> <li>(**Compliant with the standard when utilizing shielded ethernet cable.)</li> <li>EN/IEC 61000-4-8 PFMF: 50 Hz, 30A/m</li> <li>EN/IEC 61000-4-11 Voltage Dips &amp; Voltage Interruptions: 1 cycles at 60 Hz</li> </ul>
Safety	<ul style="list-style-type: none"> <li>UL, cUL, CB, IEC, EN62368-1</li> </ul>

*\* Product Specifications and features are for reference only and are subject to change without prior notice. For more information, please refer to the latest product datasheet from Cincoze's website.*

## Dimensions

CS-117C/P1301

unit: mm

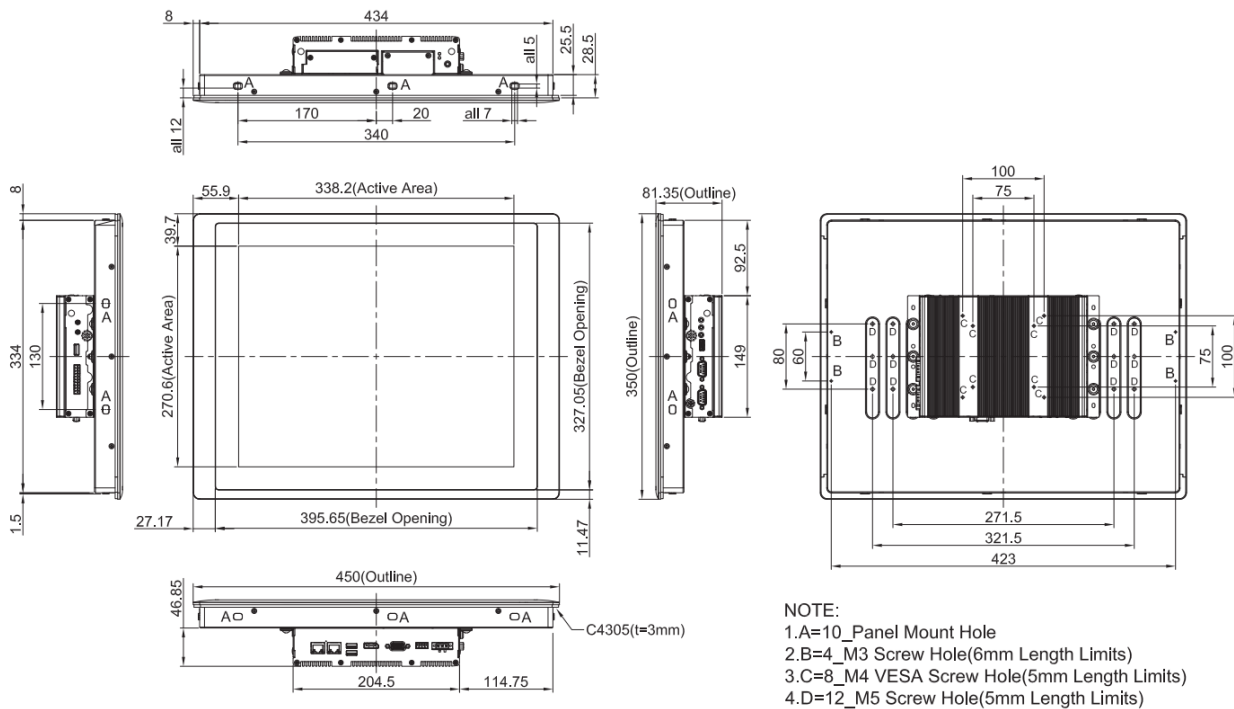

## 1.2.6 CS-119C/P1301 Series

Model Name	CS-119C
<b>Display</b>	
LCD Size	• 19" (5:4)
Max. Resolution	• 1280 x 1024
Brightness (cd/m <sup>2</sup> )	• 1600
Contract Ratio	• 1000 : 1
LCD Color	• 16.7M
Pixel Pitch	• 0.294 (H) x 0.294 (V)
Viewing Angle	• 170 / 160
Backlight MTBF	• 50,000 hrs (LED Backlight)
<b>Touchscreen</b>	
Touch Type	• Projected Capacitive
<b>Physical</b>	
Dimension (WxDxH)	• 510 x 389.3 x 63.2 mm
Weight	• 6.96 kg
Construction	• Flat Rugged Aluminum Die-casting Bezel
<b>Environment</b>	
Front Panel Protection	• IP 65 Compliant
Operating Temperature	• Ambient with Air flow: -20°C to 70°C (extended temperature peripherals)
Storage Temperature	• -20°C to 70°C
Relative Humidity	• 80% RH @ 40°C (non-condensing)
EMC	• CE, UKCA, FCC, ICES-003 Class A
EMI	<ul style="list-style-type: none"> <li>• CISPR 32 Conducted &amp; Radiated: Class A</li> <li>• EN/BS EN 55032 Conducted &amp; Radiated: Class A</li> <li>• EN/BS EN IEC 61000-3-2 Harmonic current emissions: Class A</li> <li>• EN/BS EN61000-3-3 Voltage fluctuations &amp; flicker</li> <li>• FCC 47 CFR Part 15B, ICES-003 Conducted &amp; Radiated: Class A</li> </ul>
EMS	<ul style="list-style-type: none"> <li>• EN/IEC 61000-4-2 ESD: Contact: 4 kV; Air: 8 kV</li> <li>• EN/IEC 61000-4-3 RS: 80 MHz to 1000 MHz: 3 V/m</li> <li>• EN/IEC 61000-4-4 EFT: AC Power: 1 kV; DC Power: 0.5 kV; Signal: 0.5 kV</li> <li>• EN/IEC 61000-4-5 Surges: AC Power: 2 kV; Signal: 1 kV</li> <li>• EN/IEC 61000-4-6 CS: 3V</li> <li>• EN/IEC 61000-4-8 PFMF: 50 Hz, 1A/m</li> <li>• EN/IEC 61000-4-11 Voltage Dips &amp; Voltage Interruptions: 0.5 cycles at 50 Hz</li> </ul>
Safety	• UL, cUL, CB, IEC, EN 62368-1

Model Name	P1301
<b>System</b>	
Processor	<ul style="list-style-type: none"> <li>Onboard Intel® Alder Lake-N Series Processor: <ul style="list-style-type: none"> <li>Intel® Processor N97 4 Cores Up to 3.60 GHz, TDP 12W</li> <li>Intel Atom® x7425E 4 Cores Up to 3.40 GHz, TDP 12W</li> </ul> </li> </ul>
Memory	<ul style="list-style-type: none"> <li>1x DDR5 4800MHz SO-DIMM Socket</li> <li>Supports Un-buffered and Non-ECC Type, Up to 16GB</li> </ul>
BIOS	<ul style="list-style-type: none"> <li>AMI BIOS</li> </ul>
<b>Graphics</b>	
Graphics Engine	<ul style="list-style-type: none"> <li>Integrated Intel® UHD Graphics</li> </ul>
Maximum Display Output	<ul style="list-style-type: none"> <li>Supports Triple Independent Display</li> </ul>
CDS	<ul style="list-style-type: none"> <li>1x CDS Connector (1920 x 1080 @ 60Hz)</li> </ul>
DP	<ul style="list-style-type: none"> <li>1x DisplayPort Connector (4096 x 2304 @ 60Hz)</li> <li>* Verified maximum resolution: 3840x2160 @ 60Hz</li> </ul>
VGA	<ul style="list-style-type: none"> <li>1x VGA Connector (1920 x 1200 @60Hz)</li> </ul>
<b>Audio</b>	
Audio Codec	<ul style="list-style-type: none"> <li>Realtek® ALC888, High Definition Audio</li> </ul>
Line-out	<ul style="list-style-type: none"> <li>1x Line-out, Phone Jack 3.5mm</li> </ul>
Mic-in	<ul style="list-style-type: none"> <li>1x Mic-in, Phone Jack 3.5mm</li> </ul>
<b>I/O</b>	
LAN	<ul style="list-style-type: none"> <li>2x 2.5GbE LAN, RJ45</li> <li>- GbE1 / GbE2: Intel® I225</li> </ul>
COM	<ul style="list-style-type: none"> <li>2x RS-232/422/485 with Auto Flow Control Support 5V/12V, DB9</li> </ul>
USB	<ul style="list-style-type: none"> <li>3x 10Gbps USB 3.2 Gen2x1, Type A</li> <li>1x 480Mbps USB 2.0, Type A</li> </ul>
DIO	<ul style="list-style-type: none"> <li>8x Isolated DIO (4 in/4 out), 10-Pin Terminal Block</li> </ul>
<b>Storage</b>	
SSD/HDD	<ul style="list-style-type: none"> <li>1x 2.5" Front Accessible SATA HDD/SSD Bay</li> </ul>
M.2 SSD	<ul style="list-style-type: none"> <li>1 x M.2 SSD Shared by M.2 Key B Socket</li> </ul>
<b>Expansion</b>	
M.2 Key B Socket	<ul style="list-style-type: none"> <li>1x M.2 Key B Type 3042/3052 Socket for 5G/Storage/Add-on Card Expansion</li> </ul>
M.2 Key E Socket	<ul style="list-style-type: none"> <li>1x M.2 Key E Type 2230 Socket for Wireless/Intel CNVi Module Expansion</li> </ul>
SIM Socket	<ul style="list-style-type: none"> <li>1x Front Accessible SIM Socket</li> </ul>
CFM (Control Function Module) Interface	<ul style="list-style-type: none"> <li>1x CFM Interface for optional IGN Module Expansion</li> <li>1x CFM Interface for optional PoE Module Expansion</li> </ul>
<b>Other Function</b>	
Clear CMOS Switch	<ul style="list-style-type: none"> <li>1x Clear CMOS Switch</li> </ul>
Reset Button	<ul style="list-style-type: none"> <li>1x Reset Button</li> </ul>

Instant Reboot	<ul style="list-style-type: none"> <li>• Support 0.2sec Instant Reboot Technology</li> </ul>
Watchdog Timer	<ul style="list-style-type: none"> <li>• Software Programmable Supports 256 Levels System Reset</li> </ul>
OSD Button	<ul style="list-style-type: none"> <li>• LCD On/Off, Brightness Up, Brightness Down</li> </ul>
Internal Speaker	<ul style="list-style-type: none"> <li>• AMP 2W + 2W</li> </ul>
Status LED Indicator	<ul style="list-style-type: none"> <li>• Power LED, HDD LED</li> </ul>
<b>Power</b>	
Power Button	<ul style="list-style-type: none"> <li>• 1x ATX Power On/Off Button</li> </ul>
Power Mode Switch	<ul style="list-style-type: none"> <li>• 1x AT/ATX Mode Switch</li> </ul>
Power Input	<ul style="list-style-type: none"> <li>• 9-48VDC, 3-pin Terminal Block</li> </ul>
Remote Power On/Off	<ul style="list-style-type: none"> <li>• 1x Remote Power On/Off, 2-pin Terminal Block</li> </ul>
Remote Power LED	<ul style="list-style-type: none"> <li>• 1x Remote Power LED, 2-pin Terminal Block</li> </ul>
<b>Operating System</b>	
Windows	<ul style="list-style-type: none"> <li>• Windows®11, Windows®10</li> </ul>
Linux	<ul style="list-style-type: none"> <li>• Ubuntu 22.04</li> </ul>
<b>Physical</b>	
Dimension (W x D x H)	<ul style="list-style-type: none"> <li>• 204.5 x 149 x 46.5 mm</li> </ul>
Weight Information	<ul style="list-style-type: none"> <li>• 1.57 KG</li> </ul>
Mechanical Construction	<ul style="list-style-type: none"> <li>• Extruded Aluminum with Heavy Duty Metal</li> </ul>
Mounting	<ul style="list-style-type: none"> <li>• Wall/ VESA/ CDS/ DIN Rail</li> </ul>
Physical Design	<ul style="list-style-type: none"> <li>• Fanless Design</li> <li>• Jumper-less Design</li> </ul>
<b>Reliability &amp; Protection</b>	
Reverse Power Input Protection	<ul style="list-style-type: none"> <li>• Yes</li> </ul>
Over Voltage Protection	<ul style="list-style-type: none"> <li>• Protection Range: 51-58V</li> <li>• Protection Type: shut down operating voltage, re-power on at the present level to recover</li> </ul>
Over Current Protection	<ul style="list-style-type: none"> <li>• 15A</li> </ul>
CMOS Battery Backup	<ul style="list-style-type: none"> <li>• SuperCap Integrated for CMOS Battery Maintenance-free Operation</li> </ul>
MTBF	<ul style="list-style-type: none"> <li>• 306,338 Hours - Database: Telcordia SR-332 Issue3, Method 1, Case 3</li> </ul>
<b>Environment</b>	
Operating Temperature	<ul style="list-style-type: none"> <li>• -40°C to 70°C</li> <li>* PassMark BurnInTest: 100% CPU, 2D/3D Graphics (without thermal throttling)</li> <li>* With extended temperature peripherals; Ambient with air flow</li> <li>* According to IEC60068-2-1, IEC60068-2-2, IEC60068-2-14</li> </ul>
Storage Temperature	<ul style="list-style-type: none"> <li>• -40°C to 70°C</li> </ul>
Relative Humidity	<ul style="list-style-type: none"> <li>• 95%RH @ 70°C (non-Condensing)</li> </ul>
Shock	<ul style="list-style-type: none"> <li>• Operating, 50 Grms, Half-sine 11 ms Duration (w/ SSD, according to IEC60068-2-27)</li> </ul>
Vibration	<ul style="list-style-type: none"> <li>• Operating, 1 Grms, 10-500 Hz, 3 Axes (w/ SSD, according to IEC60068-2-6)</li> <li>• Operating, 5 Grms, 5-500 Hz, 3 Axes (w/ SSD, according to IEC60068-2-64)</li> </ul>
EMC	<ul style="list-style-type: none"> <li>• CE, UKCA, FCC, ICES-003 Class A</li> </ul>

	<ul style="list-style-type: none"> <li>• EN61000-6-4, EN61000-6-2 @ DC-input 24V</li> </ul>
EMI	<ul style="list-style-type: none"> <li>• CISPR 32 Conducted &amp; Radiated: Class A</li> <li>• EN/BS EN 55032 Conducted &amp; Radiated: Class A</li> <li>• EN/BS EN IEC 61000-3-2 Harmonic current emissions: Class A</li> <li>• EN/BS EN61000-3-3 Voltage fluctuations &amp; flicker</li> <li>• FCC 47 CFR Part 15B, ICES-003 Conducted &amp; Radiated: Class A</li> </ul>
EMS	<ul style="list-style-type: none"> <li>• EN/IEC 61000-4-2 ESD: Contact: 4 kV; Air: 8 kV</li> <li>• EN/IEC 61000-4-3 RS: 80 MHz to 1000 MHz: 10 V/m</li> <li>• EN/IEC 61000-4-4 EFT: AC Power: 2 kV; DC Power: 1 kV; Signal: 1 kV</li> <li>• EN/IEC 61000-4-5 Surges: AC Power: 2 kV; Signal: 1 kV</li> <li>• EN/IEC 61000-4-6 CS: 10V</li> </ul> <p>(*Compliant with the standard when utilizing shielded ethernet cable.)</p> <ul style="list-style-type: none"> <li>• EN/IEC 61000-4-8 PFMF: 50 Hz, 30A/m</li> <li>• EN/IEC 61000-4-11 Voltage Dips &amp; Voltage Interruptions: 1 cycles at 60 Hz</li> </ul>
Safety	<ul style="list-style-type: none"> <li>• UL, cUL, CB, IEC, EN62368-1</li> </ul>

*\* Product Specifications and features are for reference only and are subject to change without prior notice. For more information, please refer to the latest product datasheet from Cincoze's website.*

## Dimensions

CS-119C/P1301

unit: mm

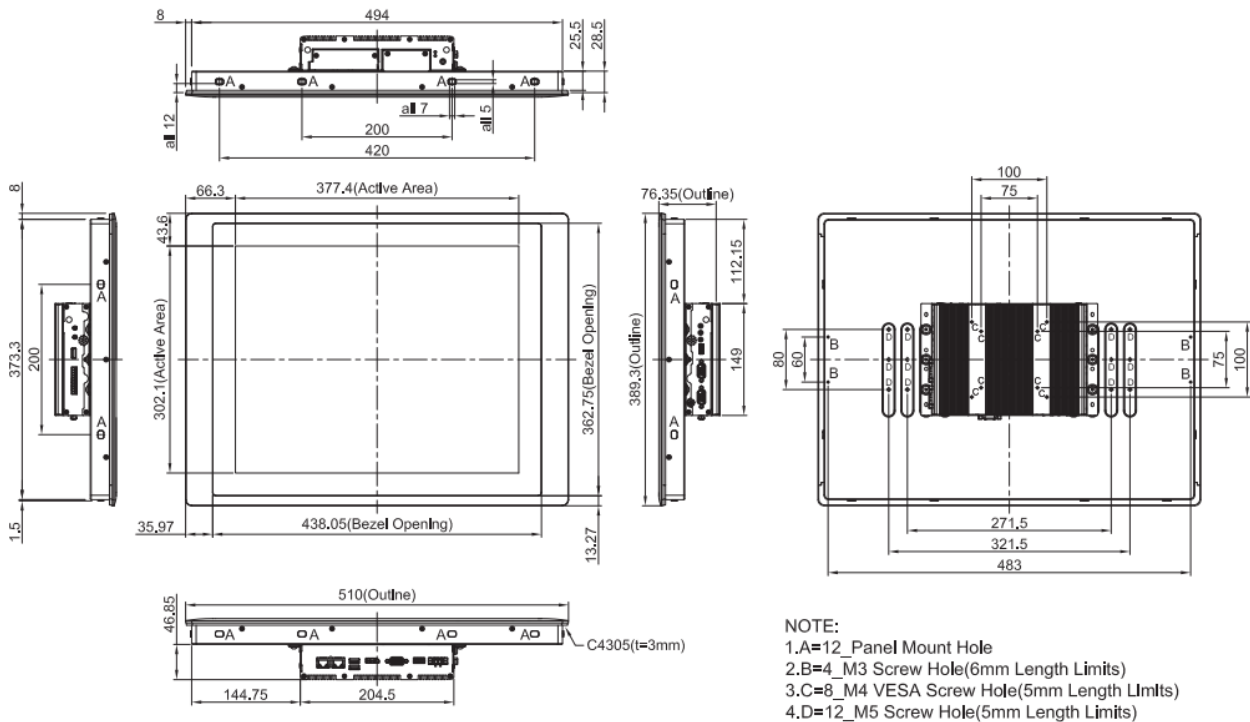

## 1.2.7 CS-W121C/P1301 Series

Model Name	CS-W121C
<b>Display</b>	
LCD Size	• 21.5" (16:9)
Max. Resolution	• 1920x1080 (Full HD)
Brightness (cd/m <sup>2</sup> )	• 1000
Contract Ratio	• 5000 : 1
LCD Color	• 16.7M
Pixel Pitch	• 0.24825 (H) x 0.24825 (V)
Viewing Angle	• 178/178
Backlight MTBF	• 50,000 hrs (LED Backlight)
<b>Touchscreen</b>	
Touch Type	• Projected Capacitive
<b>Physical</b>	
Dimension (WxDxH)	• 550 x 330.5 x 63.2mm
Weight	• 5.56 kg
Construction	• Flat Rugged Aluminum Die-casting Bezel
<b>Environment</b>	
Front Panel Protection	• IP 65 Compliant
Operating Temperature	• Ambient with Air flow: 0°C to 70°C (extended temperature peripherals)
Storage Temperature	• -20°C to 70°C
Relative Humidity	• 90% RH @ 39°C (non-condensing)
EMC	• CE, UKCA, FCC, ICES-003 Class A
EMI	<ul style="list-style-type: none"> <li>• CISPR 32 Conducted &amp; Radiated: Class A</li> <li>• EN/BS EN 55032 Conducted &amp; Radiated: Class A</li> <li>• EN/BS EN IEC 61000-3-2 Harmonic current emissions: Class A</li> <li>• EN/BS EN61000-3-3 Voltage fluctuations &amp; flicker</li> <li>• FCC 47 CFR Part 15B, ICES-003 Conducted &amp; Radiated: Class A</li> </ul>
EMS	<ul style="list-style-type: none"> <li>• EN/IEC 61000-4-2 ESD: Contact: 4 kV; Air: 8 kV</li> <li>• EN/IEC 61000-4-3 RS: 80 MHz to 1000 MHz: 3 V/m</li> <li>• EN/IEC 61000-4-4 EFT: AC Power: 1 kV; DC Power: 0.5 kV; Signal: 0.5 kV</li> <li>• EN/IEC 61000-4-5 Surges: AC Power: 2 kV; Signal: 1 kV</li> <li>• EN/IEC 61000-4-6 CS: 3V</li> <li>• EN/IEC 61000-4-8 PFMF: 50 Hz, 1A/m</li> <li>• EN/IEC 61000-4-11 Voltage Dips &amp; Voltage Interruptions: 0.5 cycles at 50 Hz</li> </ul>
Safety	• UL, cUL, CB, IEC, EN 62368-1

Model Name	P1301
<b>System</b>	
Processor	<ul style="list-style-type: none"> <li>Onboard Intel® Alder Lake-N Series Processor:               <ul style="list-style-type: none"> <li>Intel® Processor N97 4 Cores Up to 3.60 GHz, TDP 12W</li> <li>Intel Atom® x7425E 4 Cores Up to 3.40 GHz, TDP 12W</li> </ul> </li> </ul>
Memory	<ul style="list-style-type: none"> <li>1x DDR5 4800MHz SO-DIMM Socket</li> <li>Supports Un-buffered and Non-ECC Type, Up to 16GB</li> </ul>
BIOS	<ul style="list-style-type: none"> <li>AMI BIOS</li> </ul>
<b>Graphics</b>	
Graphics Engine	<ul style="list-style-type: none"> <li>Integrated Intel® UHD Graphics</li> </ul>
Maximum Display Output	<ul style="list-style-type: none"> <li>Supports Triple Independent Display</li> </ul>
CDS	<ul style="list-style-type: none"> <li>1x CDS Connector (1920 x 1080 @ 60Hz)</li> </ul>
DP	<ul style="list-style-type: none"> <li>1x DisplayPort Connector (4096 x 2304 @ 60Hz)</li> <li>* Verified maximum resolution: 3840x2160 @ 60Hz</li> </ul>
VGA	<ul style="list-style-type: none"> <li>1x VGA Connector (1920 x 1200 @60Hz)</li> </ul>
<b>Audio</b>	
Audio Codec	<ul style="list-style-type: none"> <li>Realtek® ALC888, High Definition Audio</li> </ul>
Line-out	<ul style="list-style-type: none"> <li>1x Line-out, Phone Jack 3.5mm</li> </ul>
Mic-in	<ul style="list-style-type: none"> <li>1x Mic-in, Phone Jack 3.5mm</li> </ul>
<b>I/O</b>	
LAN	<ul style="list-style-type: none"> <li>2x 2.5GbE LAN, RJ45</li> <li>- GbE1 / GbE2: Intel® I225</li> </ul>
COM	<ul style="list-style-type: none"> <li>2x RS-232/422/485 with Auto Flow Control Support 5V/12V, DB9</li> </ul>
USB	<ul style="list-style-type: none"> <li>3x 10Gbps USB 3.2 Gen2x1, Type A</li> <li>1x 480Mbps USB 2.0, Type A</li> </ul>
DIO	<ul style="list-style-type: none"> <li>8x Isolated DIO (4 in/4 out), 10-Pin Terminal Block</li> </ul>
<b>Storage</b>	
SSD/HDD	<ul style="list-style-type: none"> <li>1x 2.5" Front Accessible SATA HDD/SSD Bay</li> </ul>
M.2 SSD	<ul style="list-style-type: none"> <li>1 x M.2 SSD Shared by M.2 Key B Socket</li> </ul>
<b>Expansion</b>	
M.2 Key B Socket	<ul style="list-style-type: none"> <li>1x M.2 Key B Type 3042/3052 Socket for 5G/Storage/Add-on Card Expansion</li> </ul>
M.2 Key E Socket	<ul style="list-style-type: none"> <li>1x M.2 Key E Type 2230 Socket for Wireless/Intel CNVi Module Expansion</li> </ul>
SIM Socket	<ul style="list-style-type: none"> <li>1x Front Accessible SIM Socket</li> </ul>
CFM (Control Function Module) Interface	<ul style="list-style-type: none"> <li>1x CFM Interface for optional IGN Module Expansion</li> <li>1x CFM Interface for optional PoE Module Expansion</li> </ul>
<b>Other Function</b>	
Clear CMOS Switch	<ul style="list-style-type: none"> <li>1x Clear CMOS Switch</li> </ul>
Reset Button	<ul style="list-style-type: none"> <li>1x Reset Button</li> </ul>



Instant Reboot	• Support 0.2sec Instant Reboot Technology
Watchdog Timer	• Software Programmable Supports 256 Levels System Reset
OSD Button	• LCD On/Off, Brightness Up, Brightness Down
Internal Speaker	• AMP 2W + 2W
Status LED Indicator	• Power LED, HDD LED
<b>Power</b>	
Power Button	• 1x ATX Power On/Off Button
Power Mode Switch	• 1x AT/ATX Mode Switch
Power Input	• 9-48VDC, 3-pin Terminal Block
Remote Power On/Off	• 1x Remote Power On/Off, 2-pin Terminal Block
Remote Power LED	• 1x Remote Power LED, 2-pin Terminal Block
<b>Operating System</b>	
Windows	• Windows®11, Windows®10
Linux	• Ubuntu 22.04
<b>Physical</b>	
Dimension (W x D x H)	• 204.5 x 149 x 46.5 mm
Weight Information	• 1.57 KG
Mechanical Construction	• Extruded Aluminum with Heavy Duty Metal
Mounting	• Wall/ VESA/ CDS/ DIN Rail
Physical Design	• Fanless Design • Jumper-less Design
<b>Reliability &amp; Protection</b>	
Reverse Power Input Protection	• Yes
Over Voltage Protection	• Protection Range: 51-58V • Protection Type: shut down operating voltage, re-power on at the present level to recover
Over Current Protection	• 15A
CMOS Battery Backup	• SuperCap Integrated for CMOS Battery Maintenance-free Operation
MTBF	• 306,338 Hours - Database: Telcordia SR-332 Issue3, Method 1, Case 3
<b>Environment</b>	
Operating Temperature	• -40°C to 70°C * PassMark BurnInTest: 100% CPU, 2D/3D Graphics (without thermal throttling) * With extended temperature peripherals; Ambient with air flow * According to IEC60068-2-1, IEC60068-2-2, IEC60068-2-14
Storage Temperature	• -40°C to 70°C
Relative Humidity	• 95%RH @ 70°C (non-Condensing)
Shock	• Operating, 50 Grms, Half-sine 11 ms Duration (w/ SSD, according to IEC60068-2-27)
Vibration	• Operating, 1 Grms, 10-500 Hz, 3 Axes (w/ SSD, according to IEC60068-2-6) • Operating, 5 Grms, 5-500 Hz, 3 Axes (w/ SSD, according to IEC60068-2-64)
EMC	• CE, UKCA, FCC, ICES-003 Class A

	<ul style="list-style-type: none"> <li>• EN61000-6-4, EN61000-6-2 @ DC-input 24V</li> </ul>
EMI	<ul style="list-style-type: none"> <li>• CISPR 32 Conducted &amp; Radiated: Class A</li> <li>• EN/BS EN 55032 Conducted &amp; Radiated: Class A</li> <li>• EN/BS EN IEC 61000-3-2 Harmonic current emissions: Class A</li> <li>• EN/BS EN61000-3-3 Voltage fluctuations &amp; flicker</li> <li>• FCC 47 CFR Part 15B, ICES-003 Conducted &amp; Radiated: Class A</li> </ul>
EMS	<ul style="list-style-type: none"> <li>• EN/IEC 61000-4-2 ESD: Contact: 4 kV; Air: 8 kV</li> <li>• EN/IEC 61000-4-3 RS: 80 MHz to 1000 MHz: 10 V/m</li> <li>• EN/IEC 61000-4-4 EFT: AC Power: 2 kV; DC Power: 1 kV; Signal: 1 kV</li> <li>• EN/IEC 61000-4-5 Surges: AC Power: 2 kV; Signal: 1 kV</li> <li>• EN/IEC 61000-4-6 CS: 10V</li> </ul> <p>(*Compliant with the standard when utilizing shielded ethernet cable.)</p> <ul style="list-style-type: none"> <li>• EN/IEC 61000-4-8 PFMF: 50 Hz, 30A/m</li> <li>• EN/IEC 61000-4-11 Voltage Dips &amp; Voltage Interruptions: 1 cycles at 60 Hz</li> </ul>
Safety	<ul style="list-style-type: none"> <li>• UL, cUL, CB, IEC, EN62368-1</li> </ul>

*\* Product Specifications and features are for reference only and are subject to change without prior notice. For more information, please refer to the latest product datasheet from Cincoze's website.*

## Dimensions

CS-W121C/P1301

unit: mm

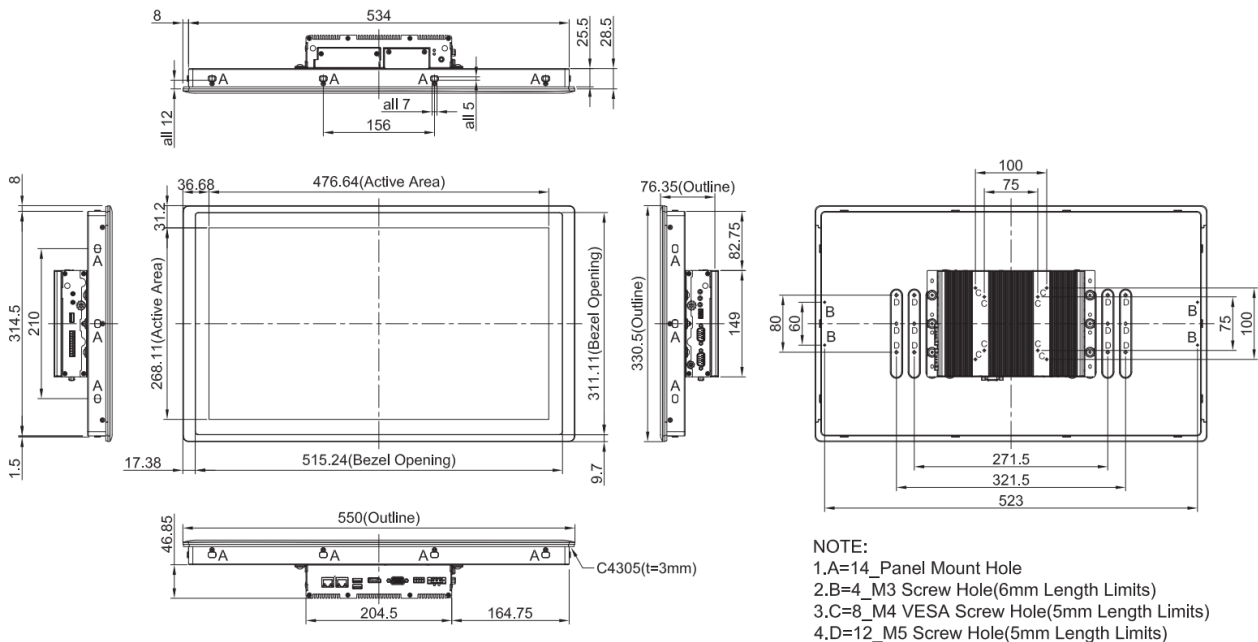

## 1.2.8 CS-W124C/P1301 Series

Model Name	CS-W124C
<b>Display</b>	
LCD Size	• 24" (16:9)
Max. Resolution	• 1920x1080
Brightness (cd/m <sup>2</sup> )	• 1500
Contract Ratio	• 5000 : 1
LCD Color	• 16.7M
Pixel Pitch	• 0.27675 (H) x 0.27675 (V)
Viewing Angle	• 178/178
Backlight MTBF	• 50,000 hrs (LED Backlight)
<b>Touchscreen</b>	
Touch Type	• Projected Capacitive
<b>Physical</b>	
Dimension (WxDxH)	• 605 x 373 x 63.2 mm
Weight	• 6.64 kg
Construction	• Flat Rugged Aluminum Die-casting Bezel
<b>Environment</b>	
Front Panel Protection	• IP 65 Compliant
Operating Temperature	• Ambient with Air flow: -20°C to 70°C (extended temperature peripherals)
Storage Temperature	• -20°C to 70°C
Relative Humidity	• 80% RH @ 50°C (non-condensing)
EMC	• CE, UKCA, FCC, ICES-003 Class A
EMI	<ul style="list-style-type: none"> <li>• CISPR 32 Conducted &amp; Radiated: Class A</li> <li>• EN/BS EN 55032 Conducted &amp; Radiated: Class A</li> <li>• EN/BS EN IEC 61000-3-2 Harmonic current emissions: Class A</li> <li>• EN/BS EN61000-3-3 Voltage fluctuations &amp; flicker</li> <li>• FCC 47 CFR Part 15B, ICES-003 Conducted &amp; Radiated: Class A</li> </ul>
EMS	<ul style="list-style-type: none"> <li>• EN/IEC 61000-4-2 ESD: Contact: 4 kV; Air: 8 kV</li> <li>• EN/IEC 61000-4-3 RS: 80 MHz to 1000 MHz: 3 V/m</li> <li>• EN/IEC 61000-4-4 EFT: AC Power: 1 kV; DC Power: 0.5 kV; Signal: 0.5 kV</li> <li>• EN/IEC 61000-4-5 Surges: AC Power: 2 kV; Signal: 1 kV</li> <li>• EN/IEC 61000-4-6 CS: 3V</li> <li>• EN/IEC 61000-4-8 PFMF: 50 Hz, 1A/m</li> <li>• EN/IEC 61000-4-11 Voltage Dips &amp; Voltage Interruptions: 0.5 cycles at 50 Hz</li> </ul>
Safety	• UL, cUL, CB, IEC, EN 62368-1

Model Name	P1301
<b>System</b>	
Processor	<ul style="list-style-type: none"> <li>Onboard Intel® Alder Lake-N Series Processor:               <ul style="list-style-type: none"> <li>Intel® Processor N97 4 Cores Up to 3.60 GHz, TDP 12W</li> <li>Intel Atom® x7425E 4 Cores Up to 3.40 GHz, TDP 12W</li> </ul> </li> </ul>
Memory	<ul style="list-style-type: none"> <li>1x DDR5 4800MHz SO-DIMM Socket</li> <li>Supports Un-buffered and Non-ECC Type, Up to 16GB</li> </ul>
BIOS	<ul style="list-style-type: none"> <li>AMI BIOS</li> </ul>
<b>Graphics</b>	
Graphics Engine	<ul style="list-style-type: none"> <li>Integrated Intel® UHD Graphics</li> </ul>
Maximum Display Output	<ul style="list-style-type: none"> <li>Supports Triple Independent Display</li> </ul>
CDS	<ul style="list-style-type: none"> <li>1x CDS Connector (1920 x 1080 @ 60Hz)</li> </ul>
DP	<ul style="list-style-type: none"> <li>1x DisplayPort Connector (4096 x 2304 @ 60Hz)</li> <li>* Verified maximum resolution: 3840x2160 @ 60Hz</li> </ul>
VGA	<ul style="list-style-type: none"> <li>1x VGA Connector (1920 x 1200 @60Hz)</li> </ul>
<b>Audio</b>	
Audio Codec	<ul style="list-style-type: none"> <li>Realtek® ALC888, High Definition Audio</li> </ul>
Line-out	<ul style="list-style-type: none"> <li>1x Line-out, Phone Jack 3.5mm</li> </ul>
Mic-in	<ul style="list-style-type: none"> <li>1x Mic-in, Phone Jack 3.5mm</li> </ul>
<b>I/O</b>	
LAN	<ul style="list-style-type: none"> <li>2x 2.5GbE LAN, RJ45</li> <li>- GbE1 / GbE2: Intel® I225</li> </ul>
COM	<ul style="list-style-type: none"> <li>2x RS-232/422/485 with Auto Flow Control Support 5V/12V, DB9</li> </ul>
USB	<ul style="list-style-type: none"> <li>3x 10Gbps USB 3.2 Gen2x1, Type A</li> <li>1x 480Mbps USB 2.0, Type A</li> </ul>
DIO	<ul style="list-style-type: none"> <li>8x Isolated DIO (4 in/4 out), 10-Pin Terminal Block</li> </ul>
<b>Storage</b>	
SSD/HDD	<ul style="list-style-type: none"> <li>1x 2.5" Front Accessible SATA HDD/SSD Bay</li> </ul>
M.2 SSD	<ul style="list-style-type: none"> <li>1 x M.2 SSD Shared by M.2 Key B Socket</li> </ul>
<b>Expansion</b>	
M.2 Key B Socket	<ul style="list-style-type: none"> <li>1x M.2 Key B Type 3042/3052 Socket for 5G/Storage/Add-on Card Expansion</li> </ul>
M.2 Key E Socket	<ul style="list-style-type: none"> <li>1x M.2 Key E Type 2230 Socket for Wireless/Intel CNVi Module Expansion</li> </ul>
SIM Socket	<ul style="list-style-type: none"> <li>1x Front Accessible SIM Socket</li> </ul>
CFM (Control Function Module) Interface	<ul style="list-style-type: none"> <li>1x CFM Interface for optional IGN Module Expansion</li> <li>1x CFM Interface for optional PoE Module Expansion</li> </ul>
<b>Other Function</b>	
Clear CMOS Switch	<ul style="list-style-type: none"> <li>1x Clear CMOS Switch</li> </ul>
Reset Button	<ul style="list-style-type: none"> <li>1x Reset Button</li> </ul>

Instant Reboot	• Support 0.2sec Instant Reboot Technology
Watchdog Timer	• Software Programmable Supports 256 Levels System Reset
OSD Button	• LCD On/Off, Brightness Up, Brightness Down
Internal Speaker	• AMP 2W + 2W
Status LED Indicator	• Power LED, HDD LED
<b>Power</b>	
Power Button	• 1x ATX Power On/Off Button
Power Mode Switch	• 1x AT/ATX Mode Switch
Power Input	• 9-48VDC, 3-pin Terminal Block
Remote Power On/Off	• 1x Remote Power On/Off, 2-pin Terminal Block
Remote Power LED	• 1x Remote Power LED, 2-pin Terminal Block
<b>Operating System</b>	
Windows	• Windows®11, Windows®10
Linux	• Ubuntu 22.04
<b>Physical</b>	
Dimension (W x D x H)	• 204.5 x 149 x 46.5 mm
Weight Information	• 1.57 KG
Mechanical Construction	• Extruded Aluminum with Heavy Duty Metal
Mounting	• Wall/ VESA/ CDS/ DIN Rail
Physical Design	• Fanless Design • Jumper-less Design
<b>Reliability &amp; Protection</b>	
Reverse Power Input Protection	• Yes
Over Voltage Protection	• Protection Range: 51-58V • Protection Type: shut down operating voltage, re-power on at the present level to recover
Over Current Protection	• 15A
CMOS Battery Backup	• SuperCap Integrated for CMOS Battery Maintenance-free Operation
MTBF	• 306,338 Hours - Database: Telcordia SR-332 Issue3, Method 1, Case 3
<b>Environment</b>	
Operating Temperature	• -40°C to 70°C * PassMark BurnInTest: 100% CPU, 2D/3D Graphics (without thermal throttling) * With extended temperature peripherals; Ambient with air flow * According to IEC60068-2-1, IEC60068-2-2, IEC60068-2-14
Storage Temperature	• -40°C to 70°C
Relative Humidity	• 95%RH @ 70°C (non-Condensing)
Shock	• Operating, 50 Grms, Half-sine 11 ms Duration (w/ SSD, according to IEC60068-2-27)
Vibration	• Operating, 1 Grms, 10-500 Hz, 3 Axes (w/ SSD, according to IEC60068-2-6) • Operating, 5 Grms, 5-500 Hz, 3 Axes (w/ SSD, according to IEC60068-2-64)
EMC	• CE, UKCA, FCC, ICES-003 Class A

	<ul style="list-style-type: none"> <li>• EN61000-6-4, EN61000-6-2 @ DC-input 24V</li> </ul>
EMI	<ul style="list-style-type: none"> <li>• CISPR 32 Conducted &amp; Radiated: Class A</li> <li>• EN/BS EN 55032 Conducted &amp; Radiated: Class A</li> <li>• EN/BS EN IEC 61000-3-2 Harmonic current emissions: Class A</li> <li>• EN/BS EN61000-3-3 Voltage fluctuations &amp; flicker</li> <li>• FCC 47 CFR Part 15B, ICES-003 Conducted &amp; Radiated: Class A</li> </ul>
EMS	<ul style="list-style-type: none"> <li>• EN/IEC 61000-4-2 ESD: Contact: 4 kV; Air: 8 kV</li> <li>• EN/IEC 61000-4-3 RS: 80 MHz to 1000 MHz: 10 V/m</li> <li>• EN/IEC 61000-4-4 EFT: AC Power: 2 kV; DC Power: 1 kV; Signal: 1 kV</li> <li>• EN/IEC 61000-4-5 Surges: AC Power: 2 kV; Signal: 1 kV</li> <li>• EN/IEC 61000-4-6 CS: 10V</li> </ul> <p>(*Compliant with the standard when utilizing shielded ethernet cable.)</p> <ul style="list-style-type: none"> <li>• EN/IEC 61000-4-8 PFMF: 50 Hz, 30A/m</li> <li>• EN/IEC 61000-4-11 Voltage Dips &amp; Voltage Interruptions: 1 cycles at 60 Hz</li> </ul>
Safety	<ul style="list-style-type: none"> <li>• UL, cUL, CB, IEC, EN62368-1</li> </ul>

*\* Product Specifications and features are for reference only and are subject to change without prior notice. For more information, please refer to the latest product datasheet from Cincoze's website.*

## Dimensions

CS-W124C/P1301

unit: mm

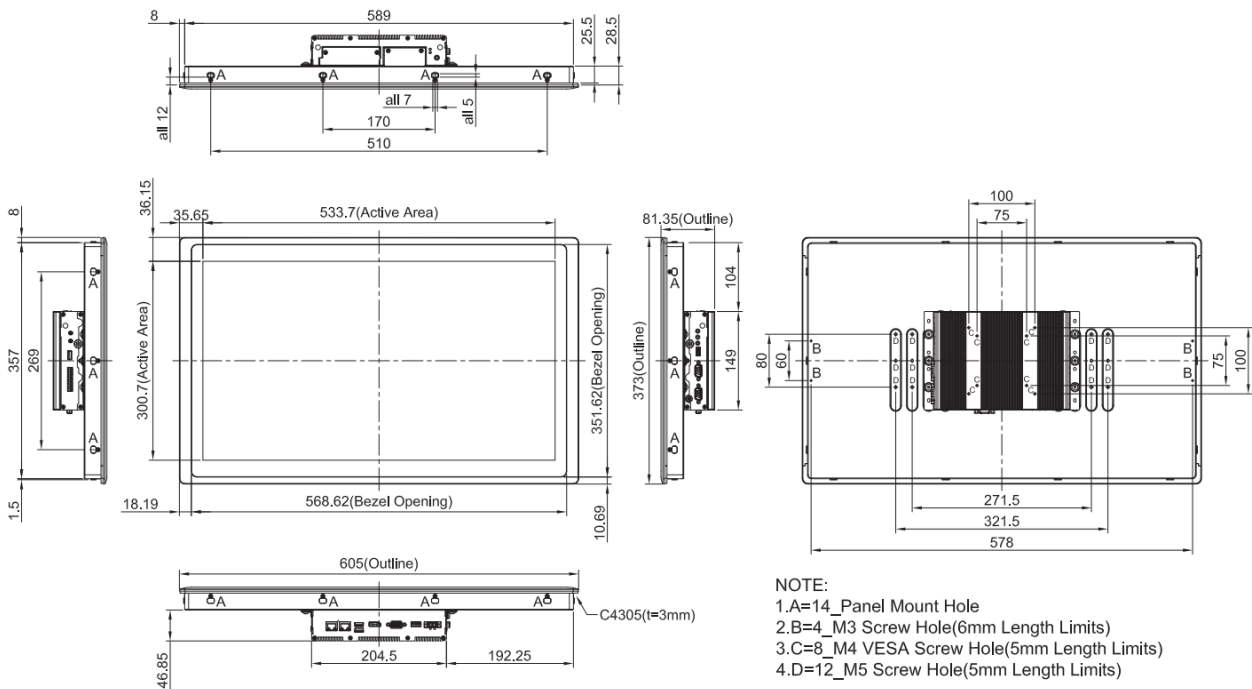

# 1.3 External Layout

## 1.3.1 Front

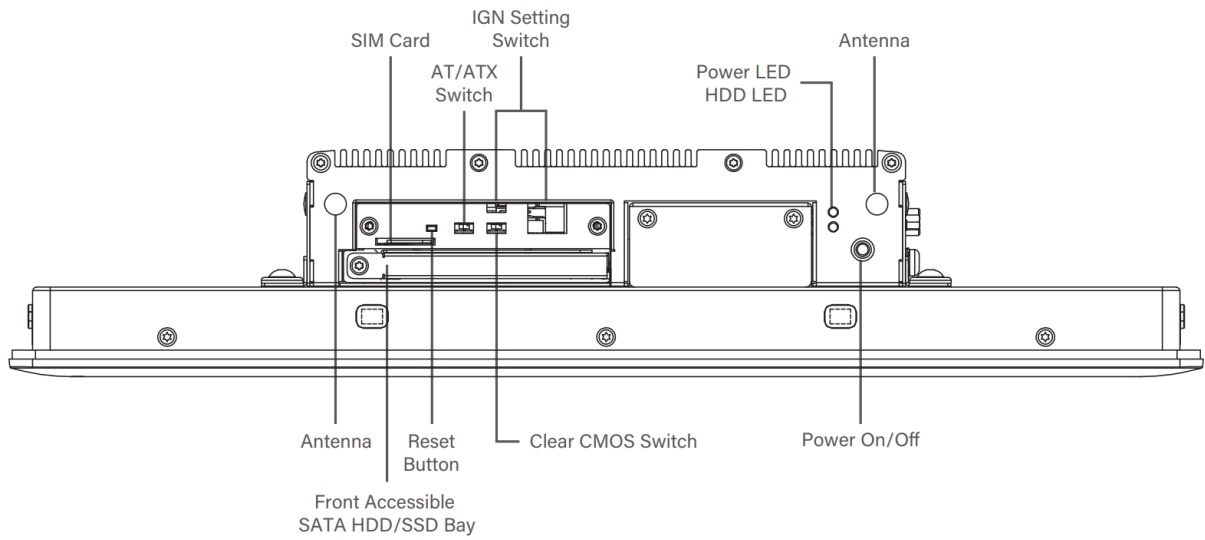

## 1.3.2 Rear

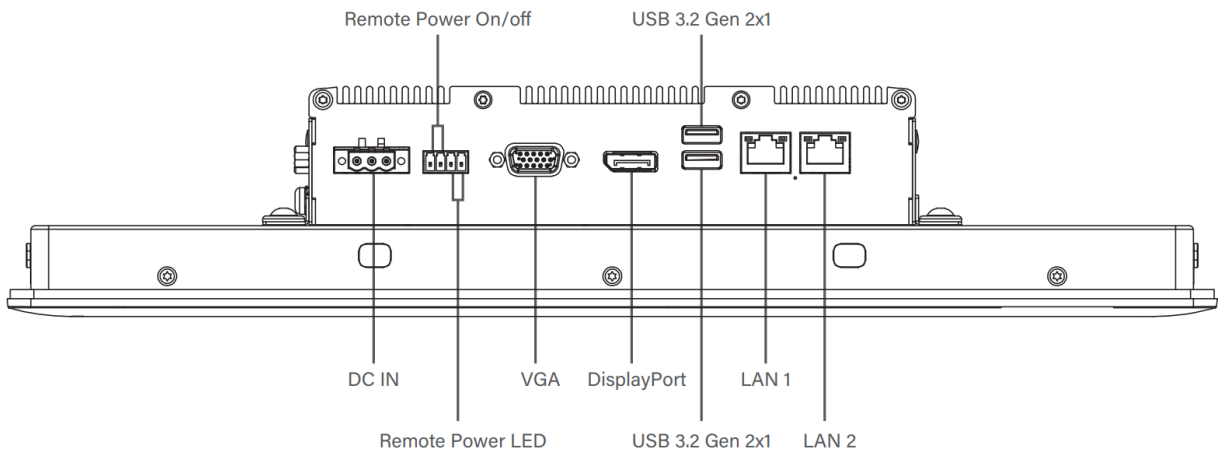

### 1.3.3 Left

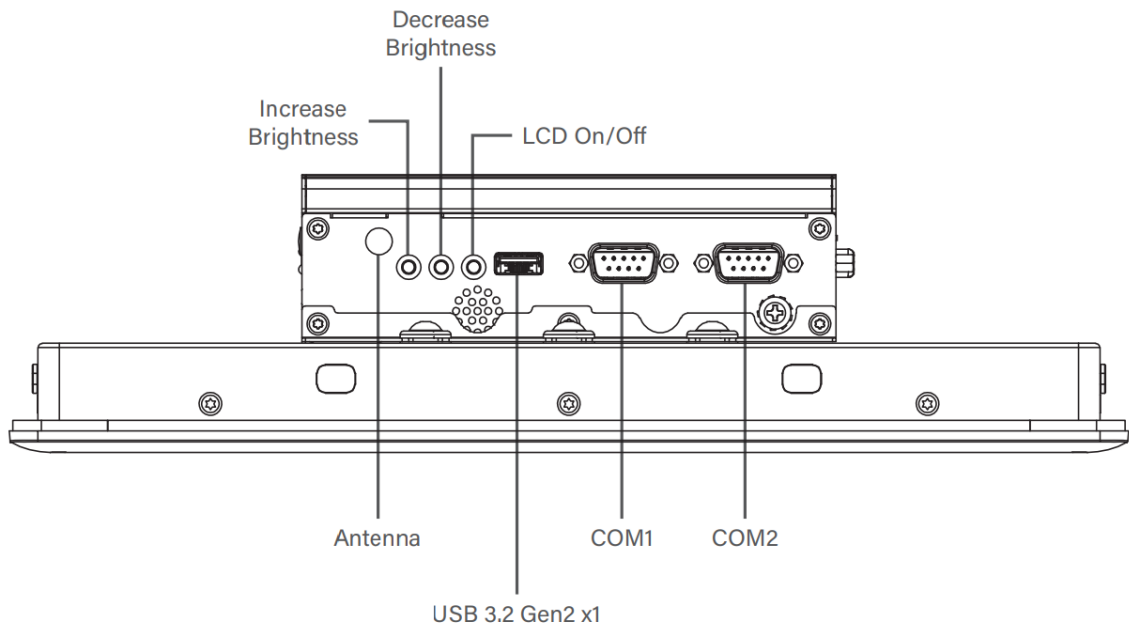

### 1.3.4 Right

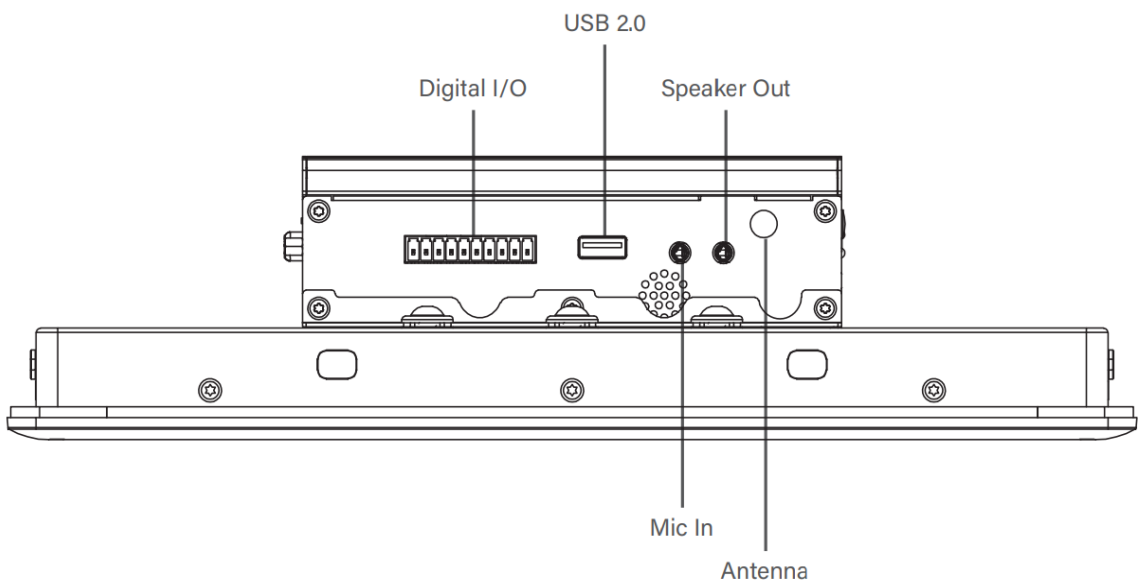





# **Chapter 2**

## **Introduction to Switches & Connectors**

## 2.1 Location of Switches and Connectors

### 2.1.1 Top View

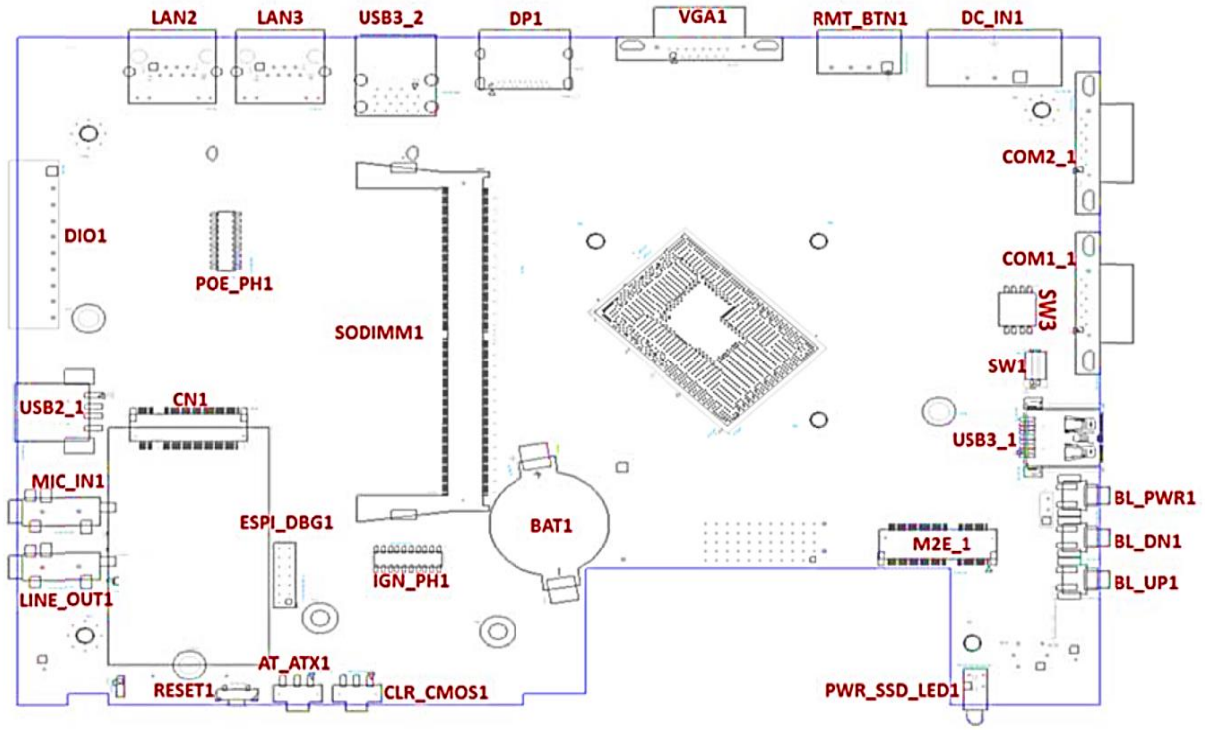

### 2.1.2 Bottom View

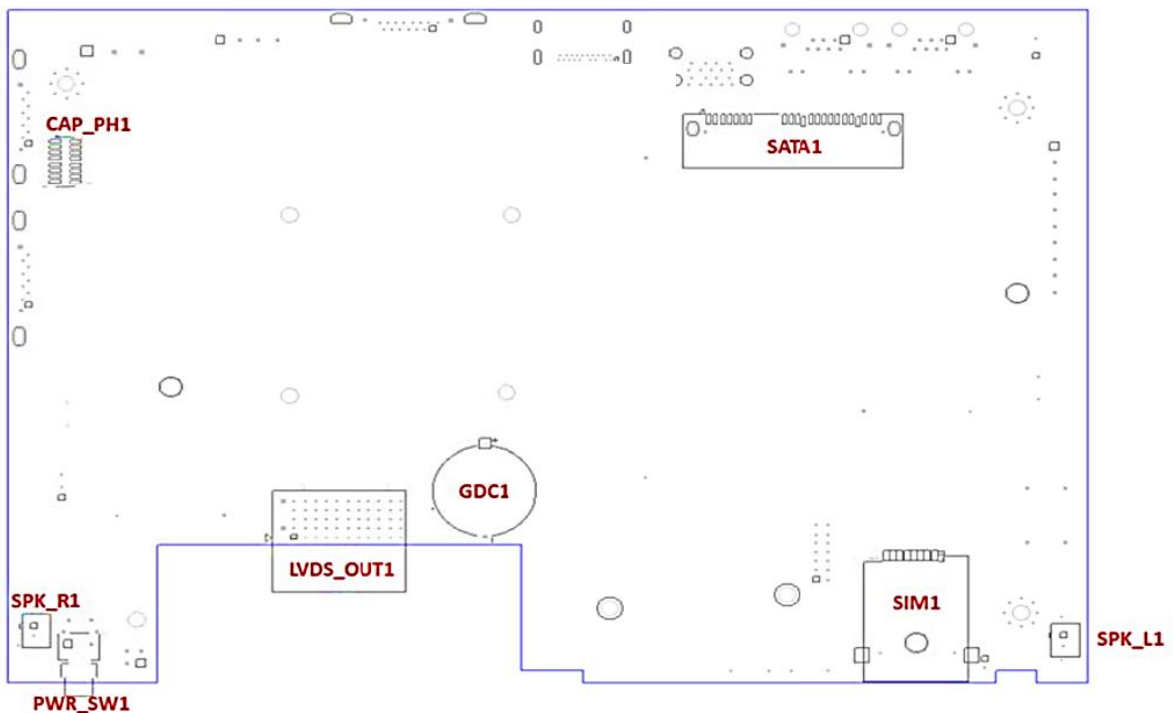

## 2.2 Switches and Connectors Definition

Location	Definition
AT_ATX1	AT / ATX Power Mode Switch
BAT1	RTC Battery Holder
BL_DN1	Backlight Decrease Button
BL_PWR1	Backlight Power on/off Button
BL_UP1	Backlight Increase Button
CAP_PH1	CAP Board to Board Connector
CLR_CMOS1	Clear CMOS Switch
CN1	M.2 Key B Socket (Support PCIE/USB3.0/ SATA interface)
COM1_1 / COM2_1	DB9 Connectors, support RS232 / RS422 / RS485
DC_IN1	3-pin DC 9-48V Power Input Connector, with Power Ignition Connector
DIO1	Digital 4IN / 4OUT Connector
DP1	Display Port
ESPI_DBG1	Debug Header Connector
GDC1	Super CAP for CMOS Backup
IGN_PH1	IGN Control Board Female Header Connector
LAN2, LAN3	LAN RJ45 Connectors
LINE_OUT1	Line-out Jack
LVDS_OUT1	LVDS Connector
M2E_1	M.2 Key E Socket (Support PCIE / CNVi Module)
MIC_IN1	Mic-in Jack
POE_PH1	PSE Board Male Header Connector
PWR_SSD_LED1	Power LED / HDD LED
PWR_SW1	System Power Button
Reset1	Reset Button
RMT_BNT1	Remote Power Button / Remote LED Connector
SATA1	SATA Connector
SIM1	SIM Card Socket
SODIMM1	DDR5 SO-DIMM Socket
SPK_L1	Speaker out Connector for Left Side
SPK_R1	Speaker out Connector for Right Side
SW1	Super CAP Switch
SW3	Power Select for COM1/COM2
USB2_1	USB 2.0 Connector
USB3_2	USB 3.2 GEN2 Connector
VGA1	VGA Connector (DB15)

## 2.3 Definition of Switches

### AT\_ATX1: AT / ATX Power Mode Switch

Switch	Definition
Left	AT Power Mode
Right	ATX Power Mode (Default)



### BL\_DN1: Backlight Brightness Decrease

Switch	Definition
Push	Backlight Decrease



### BL\_PWR1: Backlight Power on / off

Switch	Definition
Push	Backlight Power on / off switching



### BL\_UP1: Backlight Brightness Increase

Switch	Definition
Push	Backlight Increase



### CLR\_CMOS1: Clear CMOS Switch

Switch	Definition
Left	Normal (Default)
Right	Clear CMOS



### PWR\_SSD\_LED1: Power / HDD Access LED Status

Switch	LED Color	Definition
POWER LED	Green	POWER ON
	Colorless	POWER OFF
	Blinking Green	Stand by
HDD LED	Yellow	HDD Read/Write
	Colorless	No Operation



### PWR\_SW1: System Power Button

Switch	Definition
Push	Power up the System



### RESET1: Reset Button

Switch	Definition
Push	Reset System



### SW1: Super CAP SW

Location	Function	DIP1	DIP2
SW1	Super CAP Enabled	ON (Default)	ON (Default)
	Super CAP Disabled	OFF	



### SW3: Power Select for COM1/COM2

Location	Function	DIP1	DIP2	
SW3	COM1	0V(RI)	ON (Default)	ON (Default)
		5V	ON	OFF
		12V	OFF	OFF
Location	Function	DIP3	DIP4	
SW3	COM2	0V(RI)	ON (Default)	ON (Default)
		5V	ON	OFF
		12V	OFF	OFF

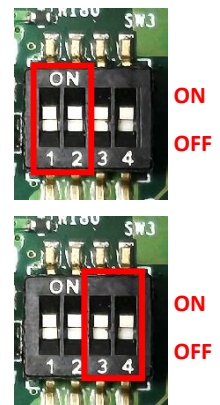

### LAN2/ LAN3: LAN LED Status Definition

Link LED Status	Definition
Steady Green	2.5 Gbps Network Link
Steady Orange	1 Gbps Network Link
Off	100 Mbps/ 10 Mbps Network Link
Act LED Status	Definition
Blinking Yellow	Data Activity
Steady Yellow	No Activity

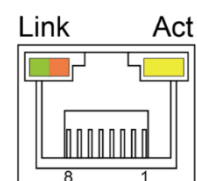

\* LAN 2 here is equivalent to LAN 2 mentioned in Chapter 1. LAN 3 here is equivalent to LAN 1 mentioned in Chapter 1.

## 2.4 Definition of Connectors

### CN1 : M.2 Key B Socket (Support PCIE/USB3.0/ SATA interface)

Pin No.	PIN Name	Pin No.	PIN Name	Pin No.	PIN Name
1	CFG3	27	GND	53	100M_CLKN
2	+3.3V	28	M.2_BT_PCMFRM	54	WAKE#
3	GND	29	PCIE2_RXN/USB3 RXN	55	100M_CLKP
4	+3.3V	30	USIM_RESET	56	NC
5	GND	31	PCIE2_RXP/USB3 RXP	57	GND
6	PULL-UP	32	USIM_CLK	58	NC
7	USB2-	33	GND	59	NC
8	PULL-UP	34	USIM_DATA	60	NC
9	USB2+	35	PCIE2_TXN/USB3 TXN	61	NC
10	LED	36	USIM_PWR	62	NC
11	GND	37	PCIE2_TXP/USB3 TXP	63	NC
12	KEY Pin	38	DEVSLP	64	NC
13	KEY Pin	39	GND	65	NC
14	KEY Pin	40	NC	66	SIM_DETECT
15	KEY Pin	41	PCIE1_RXN/SATA_RXP	67	RESET2#
16	KEY Pin	42	NC	68	SUSCLK
17	KEY Pin	43	PCIE1_RXP/SATA_RXN	69	CFG1
18	KEY Pin	44	NC	70	+3.3V
19	KEY Pin	45	GND	71	GND
20	M.2_BT_PCMCLK	46	NC	72	+3.3V
21	CFG0	47	PCIE1_TXN/SATA_TXN	73	GND
22	M.2_BT_PCMIN	48	NC	74	+3.3V
23	NC	49	PCIE1_TXP/SATA_TXP	75	CFG2
24	M.2_BT_PCMOUT	50	RESET#	76	NC
25	PULL-UP	51	GND		
26	NC	52	NC		

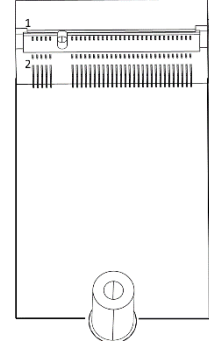

## M2E\_1 : M.2 Key E Socket (Support PCIE / CNVi Module)

Pin No.	PIN Name	Pin No.	Pin name
1	GND	2	+3.3V
3	USB_D+	4	+3.3V
5	USB_D-	6	N/A
7	GND	8	PCM_CLK
9	WGR_D1N	10	PCM_SYNC/LPC_RSTN
11	WGR_D1P	12	PCM_IN
13	GND	14	PCM_OUT
15	WGR_D0N	16	N/A
17	WGR_D0P	18	GND
19	GND	20	UART_WAKE#
21	WGR_CLKN	22	UART_RX/BRI_RSP
23	WGR_CLKP	24	Key
25	Key	26	Key
27	Key	28	Key
29	Key	30	Key
31	Key	32	UARTX/RGI_DT
33	GND	34	UART_CTS/RGI_RSP
35	PETP0	36	UART_RTS/BRI_DT
37	PETN0	38	N/A
39	GND	40	N/A
41	PERP0	42	N/A
43	PERN0	44	N/A
45	GND	46	N/A
47	REFCLKP0	48	N/A
49	REFCLKN0	50	SUSCLK
51	GND	52	PERST0#
53	CLKREQ0#	54	W_DISABLE2# (PULL-UP)
55	PEWAKE0#	56	W_DISABLE1# (PULL-UP)
57	GND	58	I2C_DATA
59	WTD1N	60	I2C_CLK
61	WTD1P	62	N/A

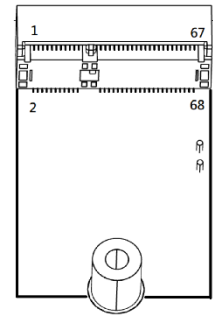

63	GND	64	REF_CLK
65	WT_D0N	66	N/A
67	WT_D0P	68	SUSCLK
69	GND	70	+3.3V
71	WTCLKN	72	+3.3V
73	WTCLK	74	+3.3V
75	GND		

### COM1\_1 / COM2\_1: RS232 / RS422 / RS485 Connector

Connector Type: 9-pin D-Sub

Pin	RS232 Definition	RS422 / 485 Full Duplex Definition	RS485 Half Duplex Definition
1	DCD	TX-	DATA -
2	RXD	TX+	DATA +
3	TXD	RX+	
4	DTR	RX-	
5	GND		
6	DSR		
7	RTS		
8	CTS		
9	RI		



### DC\_IN1: DC 9-48V Power Input Connector, with Power Ignition Connector

Connector Type: Terminal Block 1x3 3-pin, 5.0mm pitch

Pin	Definition
1	+9-48VIN
2	Ignition (IGN)
3	GND

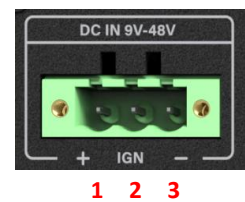

**CAUTION**  
(ATTENTION)

Please disconnect the power source before mounting the DC power cables or connecting the DC power connector to system.

(Veuillez débrancher la source d'alimentation avant de monter les câbles d'alimentation CC ou de connecter le connecteur d'alimentation CC au système.)



### DIO1: Digital 4IN / 4OUT Connector

Connector Type: Terminal Block 1X10 10-pin, 3.5mm pitch

Pin	Definition	Pin	Definition
1	XCOM+ (DC INPUT)	6	DO5
2	DI1	7	DO6
3	DI2	8	DO7
4	DI3	9	DO8
5	DI4	10	XCOM- (GND)

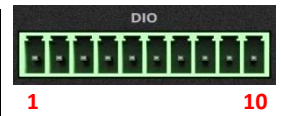

### RMT\_BNT1: Remote Power Button / Remote LED Connector

Remote Power LED connector can connect an external LED indicator up to 10mA.

Connector Type: Terminal Block 1X4 4-pin, 3.5mm pitch

Pin	Definition
1	Remote Power Button
2	GND
3	Remote Power LED
4	GND

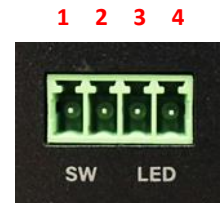

**WARNING**  
**(AVERTIR)**

**Do not apply power to this connector! This port is used to connect a SWITCH!**

**(Ne mettez pas sous tension ce connecteur! Ce port est utilisé pour connecter un SWITCH!)**

## 2.5 Optional Module Pin Definition & Settings

### 2.5.1 CFM-IGN101 Module

#### SW2 (on the module) : IGN Module Timing Setting Switch

Set shutdown delay timer when ACC is turned off

Pin 1	Pin 2	Pin 3	Pin 4	Definition
ON (IGN Enabled)	ON	ON	ON	0 second
	ON	ON	OFF	1 minute
	ON	OFF	ON	5 minutes
	ON	OFF	OFF	10 minutes
/	OFF	ON	ON	30 minutes
	OFF	ON	OFF	1 hour
	OFF	OFF	ON	2 hours
	OFF	OFF	OFF	Reserved (0 second)

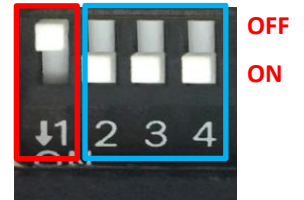

Default setting of Pin1 to Pin4 is OFF/ON/ON/ON.

#### 24V\_12V\_1 (on the module) : IGN Module Voltage Mode Setting Switch

##### 12V / 24V Car Battery Switch

Switch	Definition
Left	24V Car Battery Input (Default)
Right	12V Car Battery Input





# **Chapter 3**

## **System Setup**

### 3.1 Removing Top Cover



**WARNING**  
**(AVERTIR)**

In order to prevent electric shock or system damage, must turn off power and disconnect the unit from power source before removing the chassis cover.  
(Afin d'éviter tout risque d'électrocution ou d'endommagement du système, vous devez couper l'alimentation et débrancher l'appareil de la source d'alimentation avant de retirer le couvercle du châssis.)

Step 1. Loosen the 8 screws of front and rear panel, then place them aside.

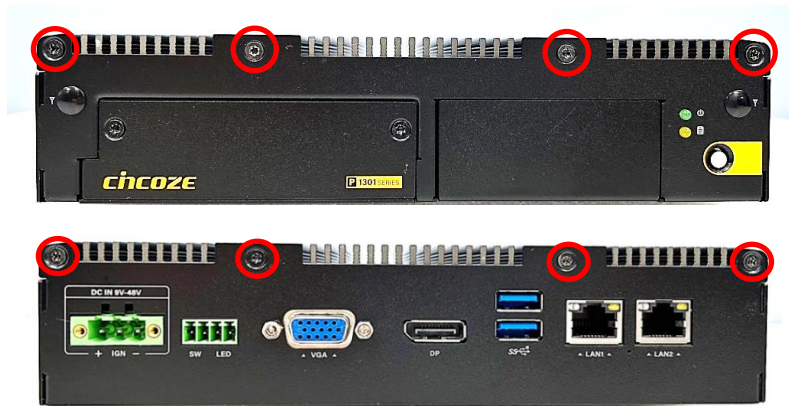

Step 2. Remove the cover from the chassis.



Step 3. Place the top cover gently.

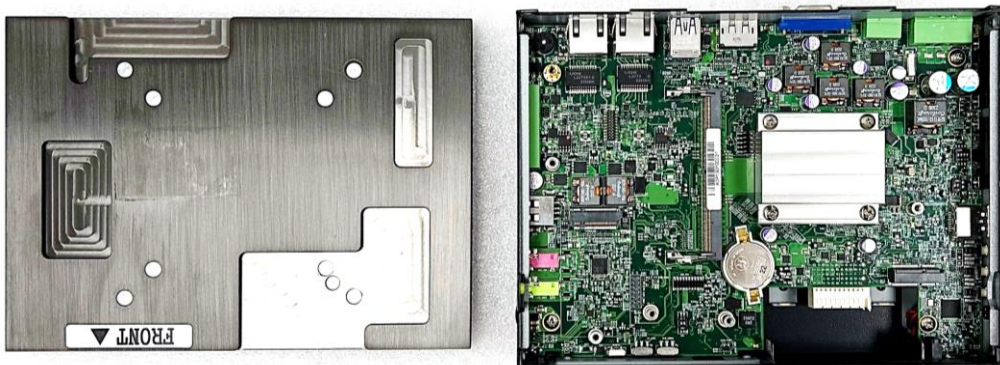

## 3.2 Installing SO-DIMM Memory

Step 1. Locate the SO-DIMM sockets.

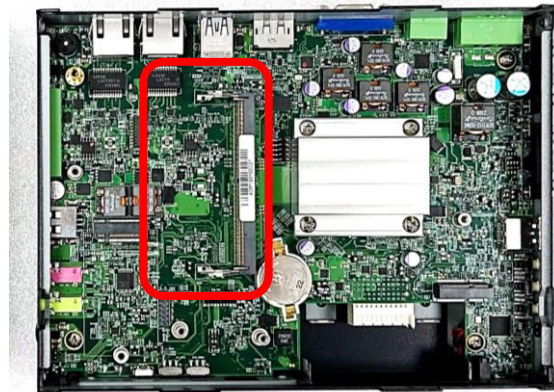

Step 2. Tilt the SO-DIMM module at a 45-degree angle and insert it to SO-DIMM socket until the gold-pated connector of module contacted firmly with the socket.



Step 3. Press the modules down until it's fixed firmly by the two locking latches on each side.

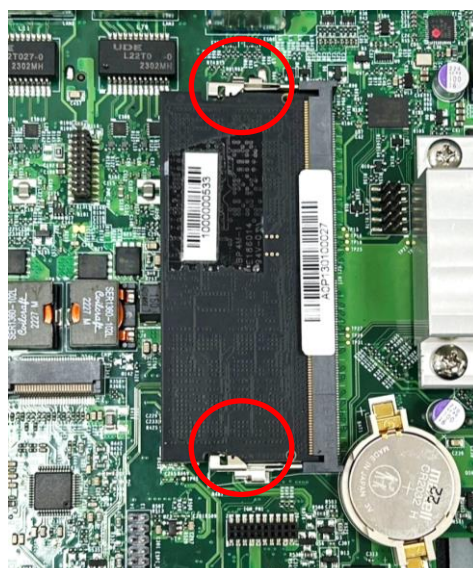

## 3.3 Installing M.2 Key B Card

### 3.3.1 M.2 Key B type 3052

Step 1. Locate the M.2 Key B slot.

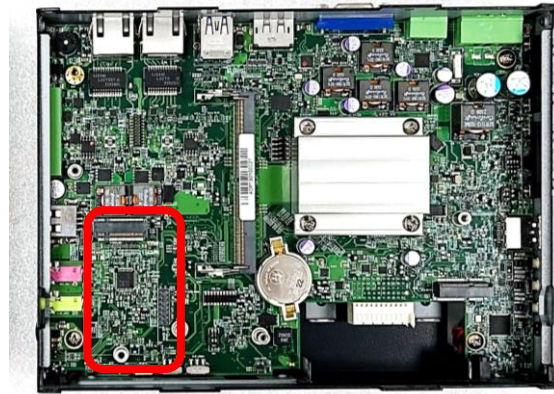

Step 2. Insert the M.2 Key B card at a 45-degree angle and insert it to the slot until the gold-pated connector of module contacted firmly with the slot.

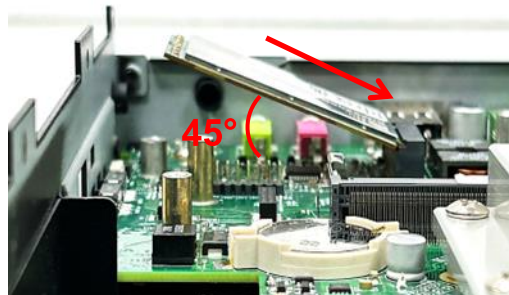

Step 3. Press down the module and fasten the screw to secure the module.



### 3.3.2 M.2 Key B type 3042

Step 1. Locate the M.2 Key B slot.

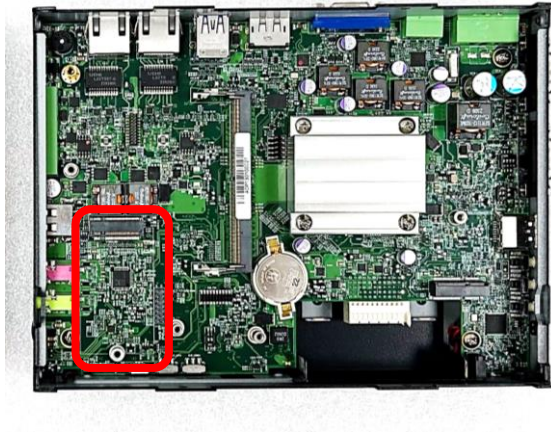

Step 2: Align the M.2 Key B Type 3052 to 3042 Adapter Bracket with the corresponding screw hole. Secure the bracket in place and fasten the screw.



Step 3. Insert the M.2 Key B card at a 45-degree angle and insert it to the slot until the gold-pated connector of module contacted firmly with the slot.



Step 4. Press down the module and fasten the screw to secure the module.



### 3.4 Installing M.2 Key E Card

Step 1. Locate the M.2 Key E slot on the system board.

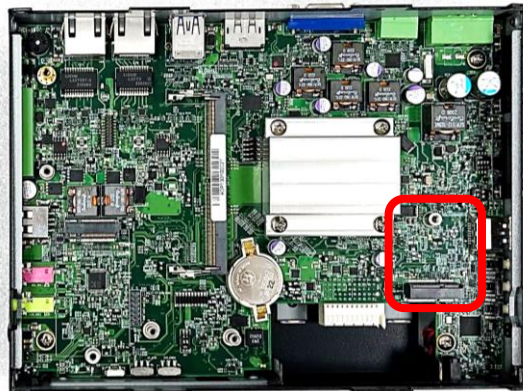

Step 2. Tilt the M.2 Key E card at a 45-degree angle and insert it to the socket until the golden finger connector of the card seated firmly.

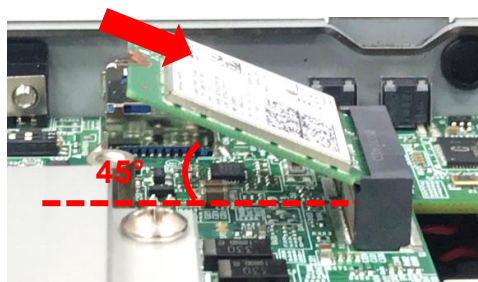

Step 3. Press the card down and secure it with one screw.





### 3.5 Installing Antenna(s)

Please install a Wireless LAN card before the antenna installation.

Step 1. Remove the antenna hole cover(s) on the front or the side panel.



Step 2. Have the antenna jack penetrate through the hole.



Step 3. Put on the washer and fasten the nut with the antenna jack.

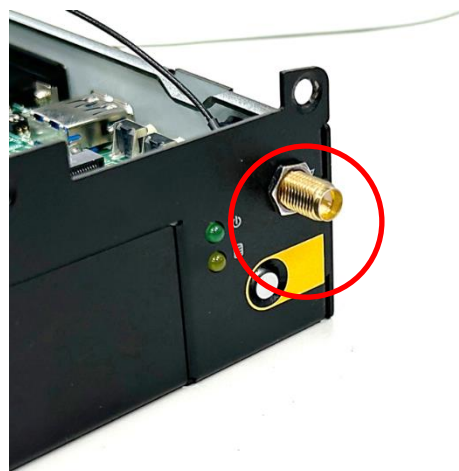

Step 4. Assemble the antenna and antenna jack together.



Step 5. Attach the RF connector at another end of cable onto the module.

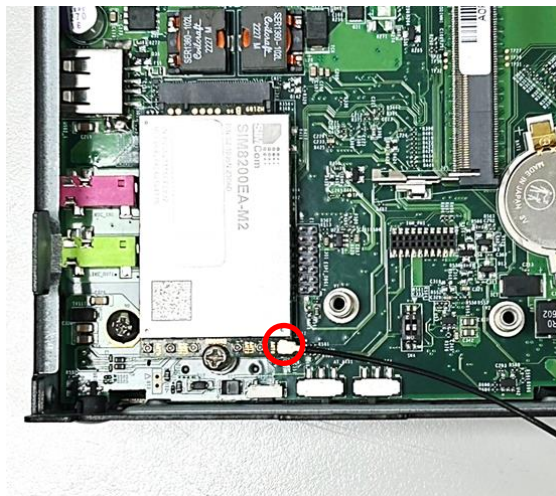

## 3.6 Installing CPU Thermal Pad

Step 1. Remove the protective films of the Thermal Pad's both sides and then place the thermal pad on the CPU heatsink.

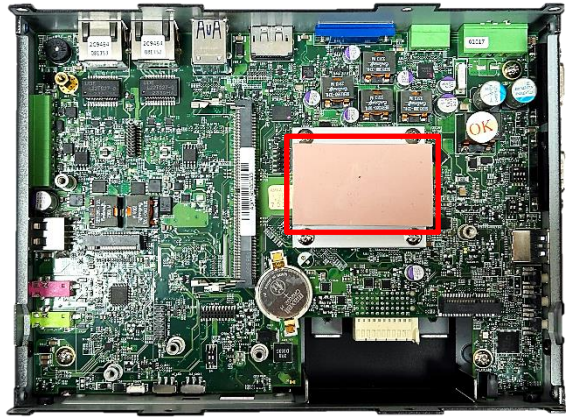

**CAUTION**  
(ATTENTION)

**Before assembling the system's chassis cover, please make sure the protective film on the Thermal Pad has been removed!**

**(Avant d'assembler le couvercle du châssis du système, assurez-vous que le film protecteur sur le coussin thermique a été retiré ! d'alimentation CC au système.)**

## 3.7 Installing Top Cover

Step 1. Put on the cover.



Step2. Fasten the 8 screws to fix the cover.

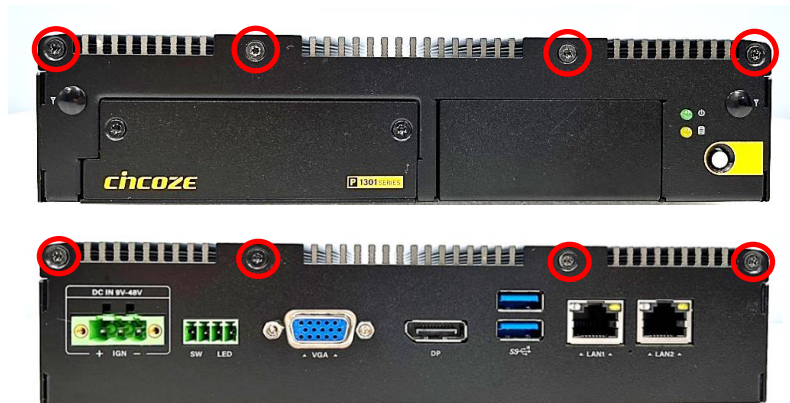

### 3.8 Installing SATA Hard Drive

Step 1. Loosen the 2 screws on the front panel to remove the cover plate.



Step 2. Loosen the screw on the HDD bracket.



Step 3. Pull out the HDD bracket.



Step 4. Make the bottom side of the HDD face up, place the HDD bracket on it. Ensure the direction of bracket is correct and use 4 provided screws to assemble HDD and HDD bracket together.



Step 5. Align the HDD bracket with the entrance of HDD bay. And insert the HDD bracket until the connector of HDD contact the SATA connector firmly.



Step 6. Fasten the screw on the HDD bracket.



Step 7. Fasten the 2 screws on the front panel.



### 3.9 Installing SIM Card

Step 1. Loosen the 2 screws on front panel to remove cover plate.



Step 2. SIM card slot is at the front panel of the system.



Step 3. Insert the SIM card until you hear a click sound; that indicates the installation is complete.



## 3.10 Installing CFM Modules

Please refer to chapter 3.1 to remove the top cover of the P1301 system first.

### 3.10.1 CFM-IGN101

Step 1. Locate the IGN connector on system motherboard as indicated.

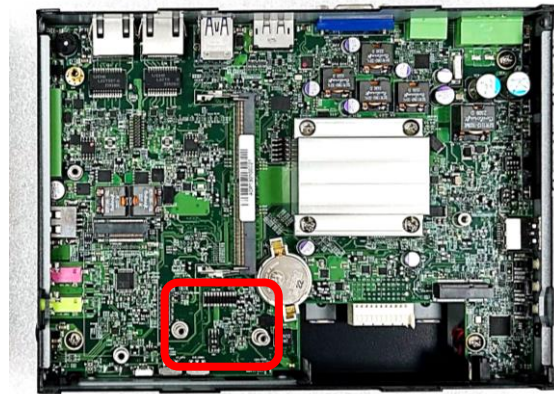

Step 2. Insert CFM-IGN module vertically to the female connector on the system's mainboard, and fasten the 2 screws to fix it.

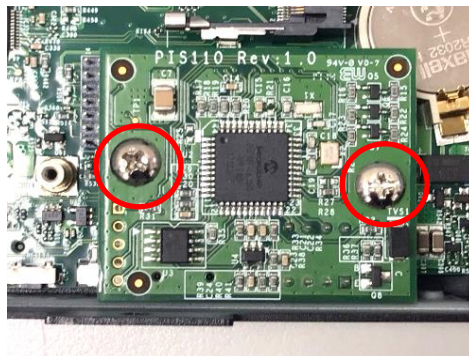

Step 3. Loosen the 2 screws on front panel to remove cover plate.



Step 4. IGN function switch will be seen at the front panel of the system.





### 3.10.2 CFM-PoE02

Step 1. Locate the PoE connector on system motherboard as indicated.

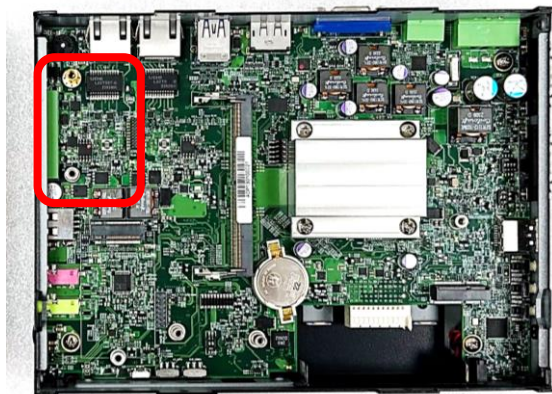

Step 2. Insert the female connector of CFM-PoE module to the male connector on system motherboard.

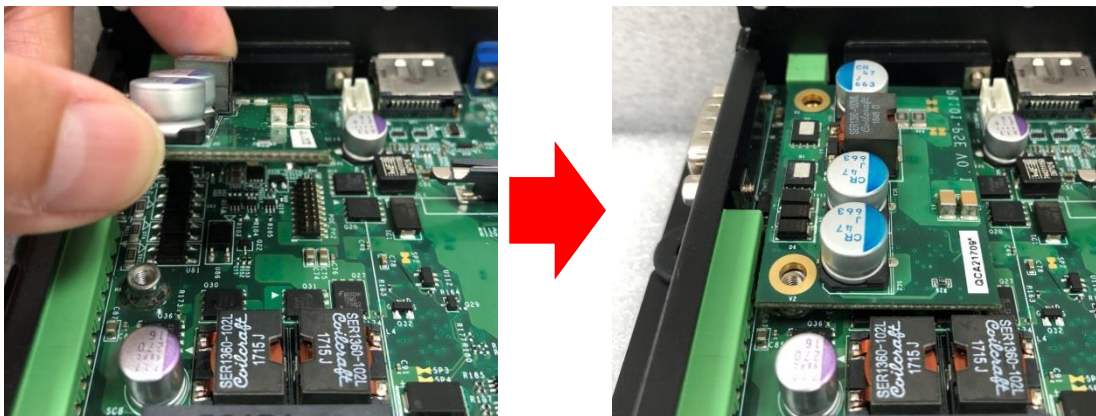

Step 3. Turn over the heatsink and paste the thermal pad onto the marked by red squares.

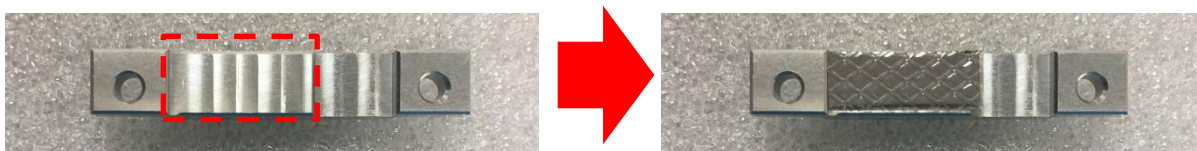

**CAUTION**  
(ATTENTION)

**Before putting on the thermal block (in the next step), please make sure the protective film on the Thermal Pad has been removed!**

**(Avant de mettre le bloc thermique (à l'étape suivante), veuillez vous assurer que le film protecteur sur le coussin thermique a été retiré!)**

Step 4. Paste the heatsink onto the CFM-PoE module carefully and fasten 2 screws to fix it.

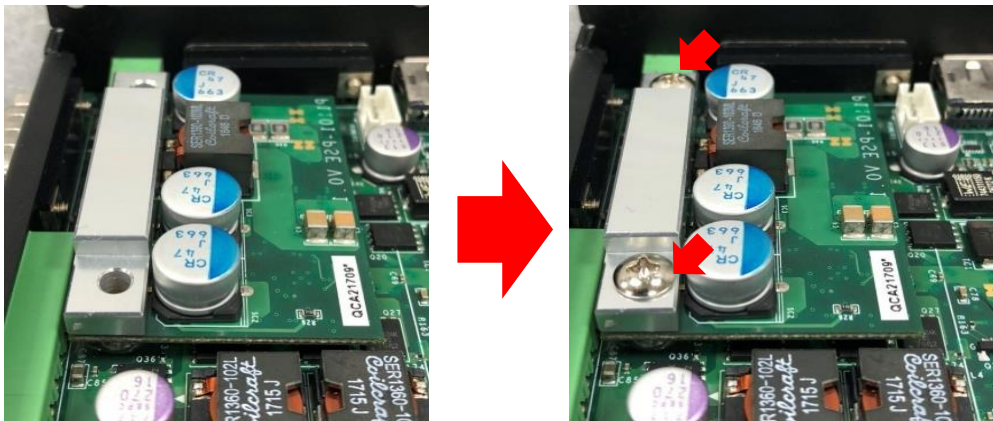

Step 5. Paste the thermal pads onto the heatsink and coil carefully.

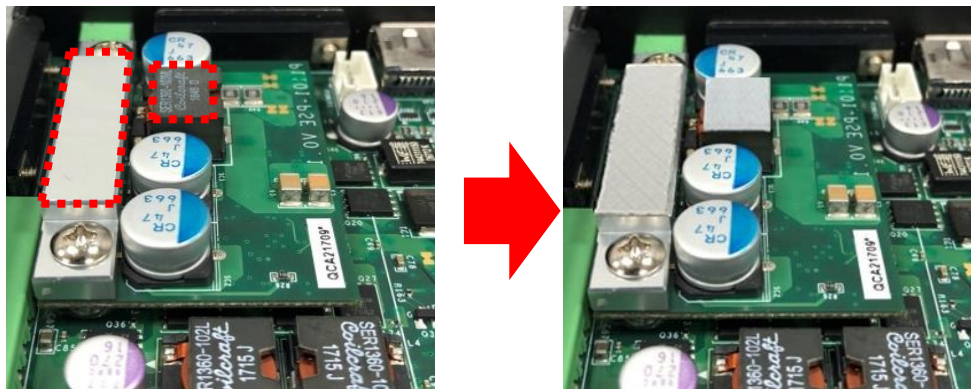

**CAUTION**  
(ATTENTION)

**Before assembling the system's chassis cover, please make sure the protective film on the Thermal Pad has been removed!**  
(Avant d'assembler le couvercle du châssis du système, assurez-vous que le film protecteur sur le coussin thermique a été retiré !d'alimentation CC au système.)

Step 6. When the system is power on, please note that the POE LED will light on if the POE module is properly installed.



### 3.11 Disassembling the CS Display Module

The complete shipping product is already the CS display module already installed on the system P1301. This chapter is to introduce how to disassemble CS display module from the system P1301.

Step 1. Remove the 6 screws on the display module and then disconnect the module.



### 3.12 Installing Panel Mount

Step 1. Accessories provided by Cincoze are as below. (Please note that the quantity of mounting kits varies with the size of the display module, please refer to the datasheet for the actual quantity)

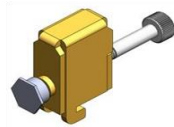

Mounting Kits

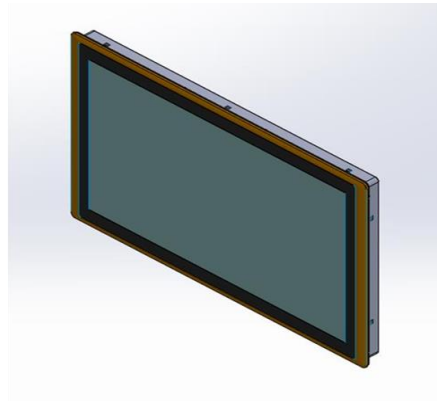

Panel Mount PPC

Panel Mount with customer's fixture  
(Front View)

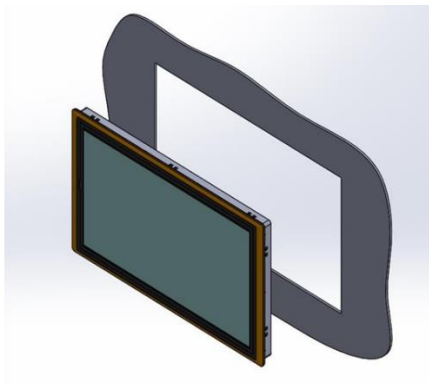

Step 2. All mounting kits displayed are to be inserted into holes.

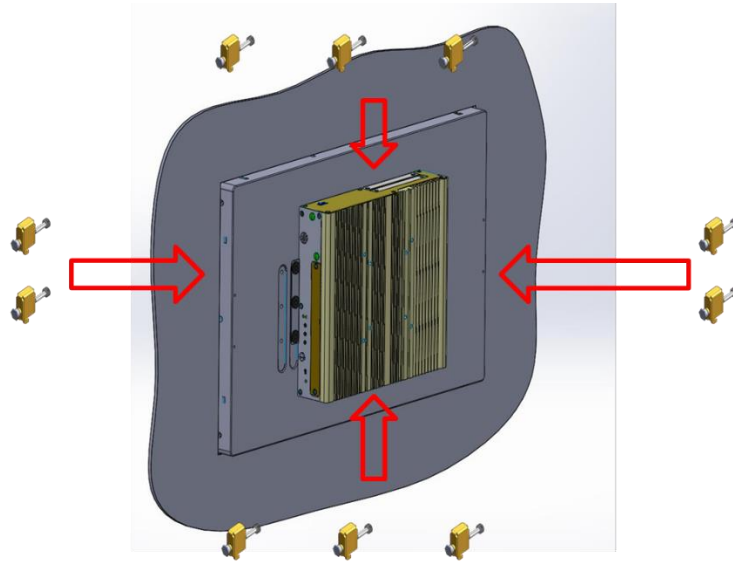

Step 3. Installation preparation and steps.

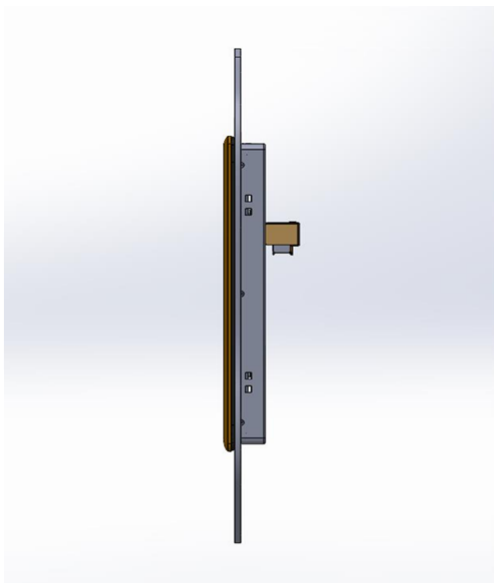

Panel mount side view with LVDS connector of CS series

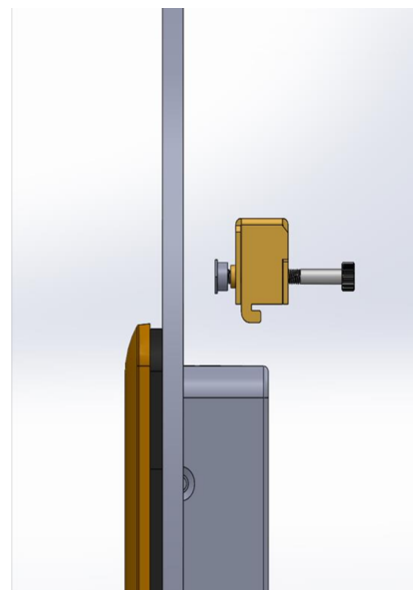

Before Mounting Kits are installed

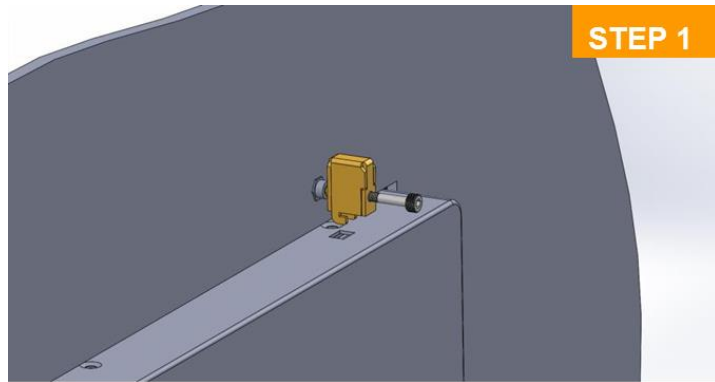

Position panel mount kits

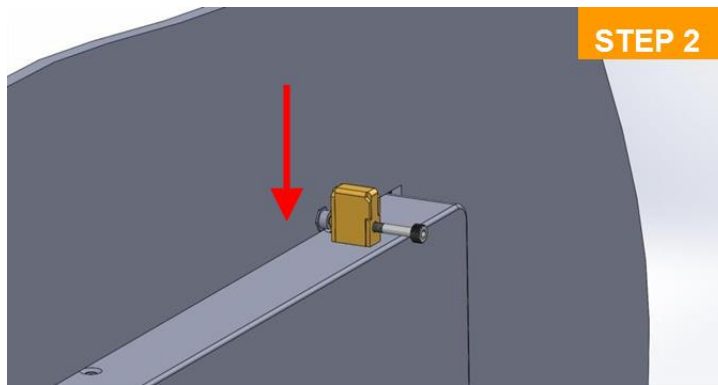

Insert the panel mounting kit into bottom hole

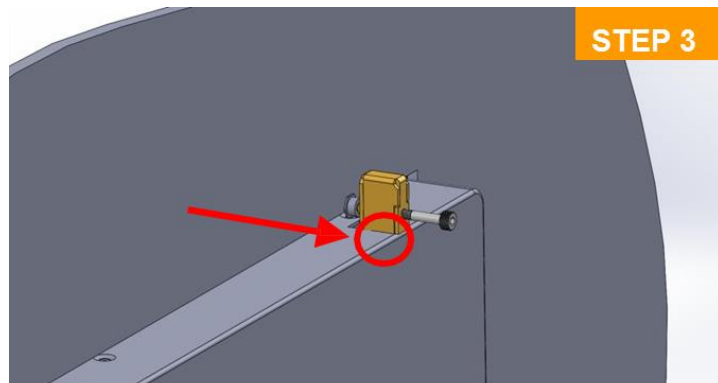

Slide the kit toward back

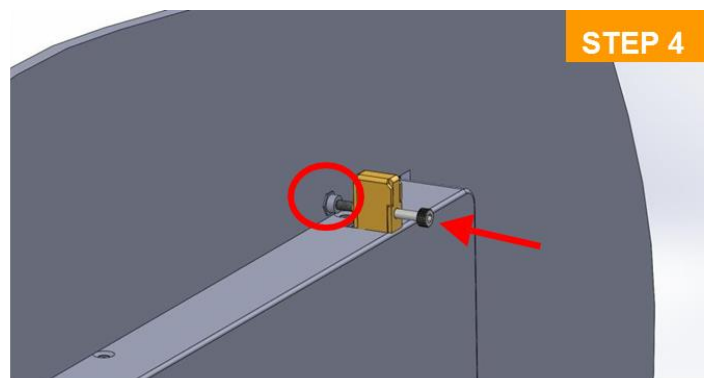

Tighten the screw forward until the front screw just touches the surface

Step 4. Apply all mount kits to the rest of holes. And you have completed the panel mount installation, as shown below.

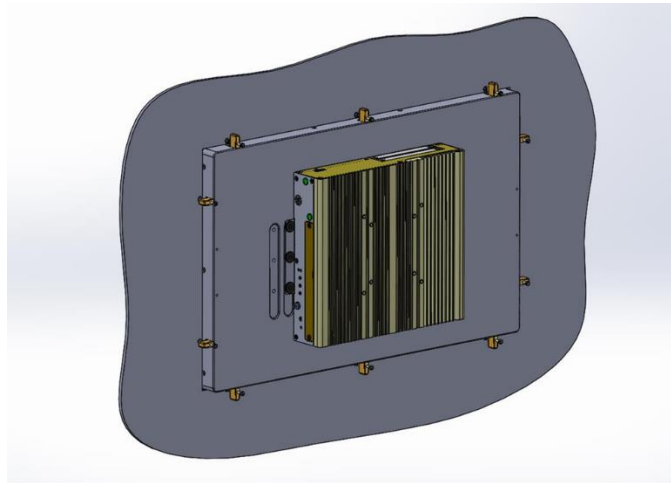

### 3.13 Installing VESA Mount

The following picture indicates VESA mounting hole pattern on the P1301, which is compliant with VESA mounting standard.

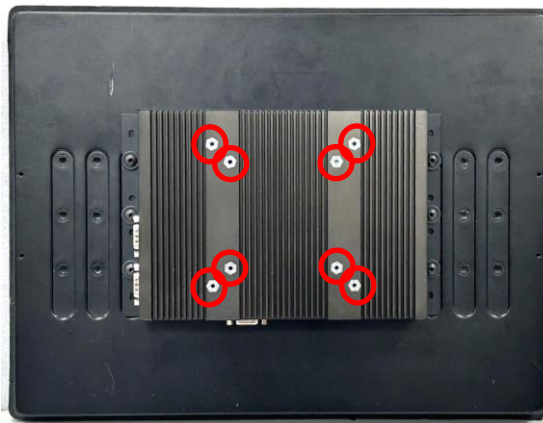

Step 1. The following picture uses a panel PC (P1301+ Display Module) as a demonstration. To attach the panel PC to a VESA stand, please fasten eight screws as indicated to fix it on the stand.

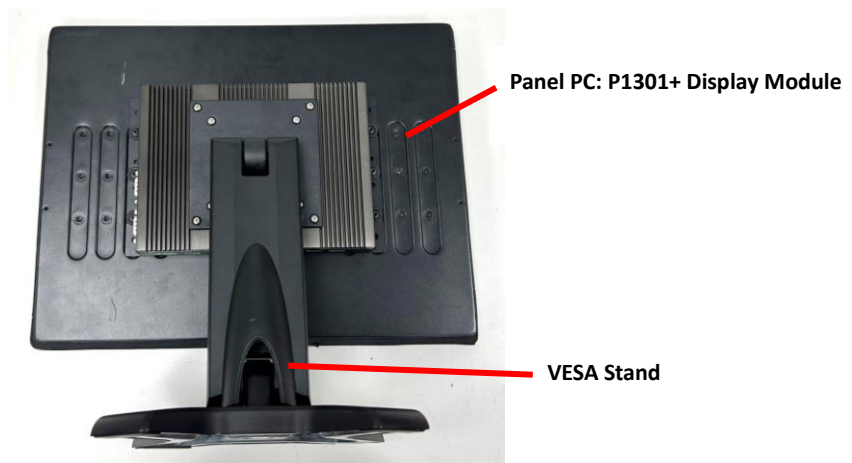

### 3.14 Installing Rack Mount

Step 1. Locate and align the screw holes on the PC module with those on the rack mount base. Fasten 8 M4x6 screws securely for a stable connection.

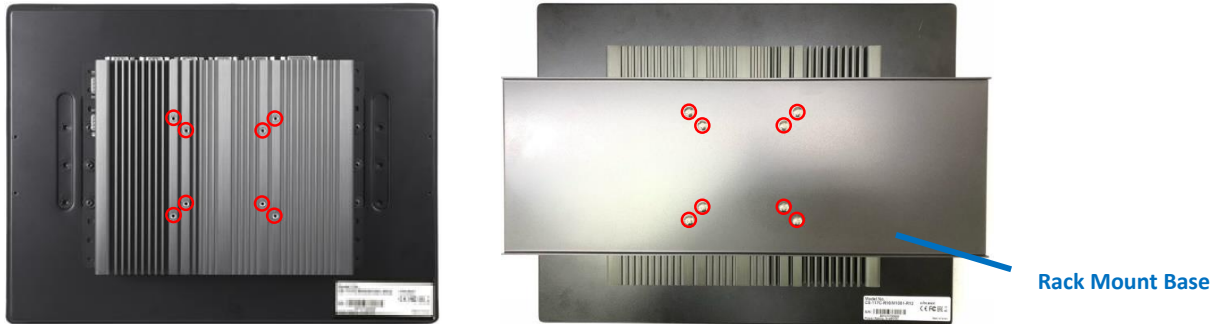

Step 2. Locate the mounting holes on the rack mount brackets, as illustrated in the pictures below, depicting three different sets of screw holes for mounting the 8.4" ~ 17" Panel PC series or the 19" ~ 24" Panel PC series.

#### For 8.4" ~ 17" Panel PC

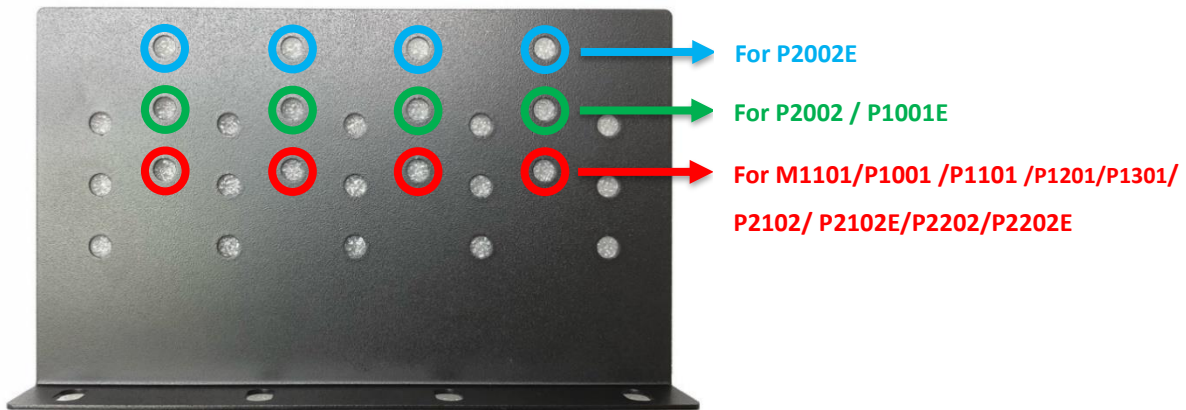

#### For 19" ~ 24" Panel PC

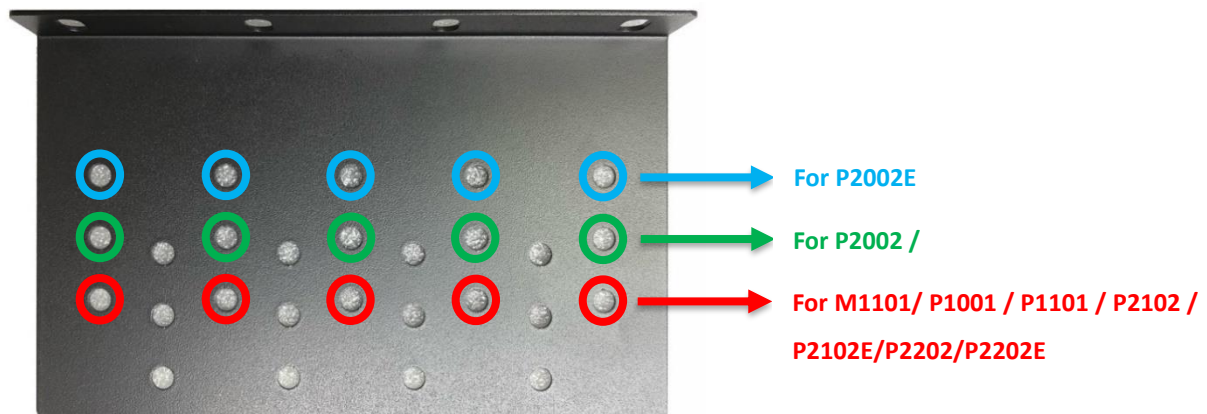

Step 3. Assemble the brackets and the rack mount base by securing 4 M5x6 screws on each side.

**For 8.4" ~ 17" Panel PC**

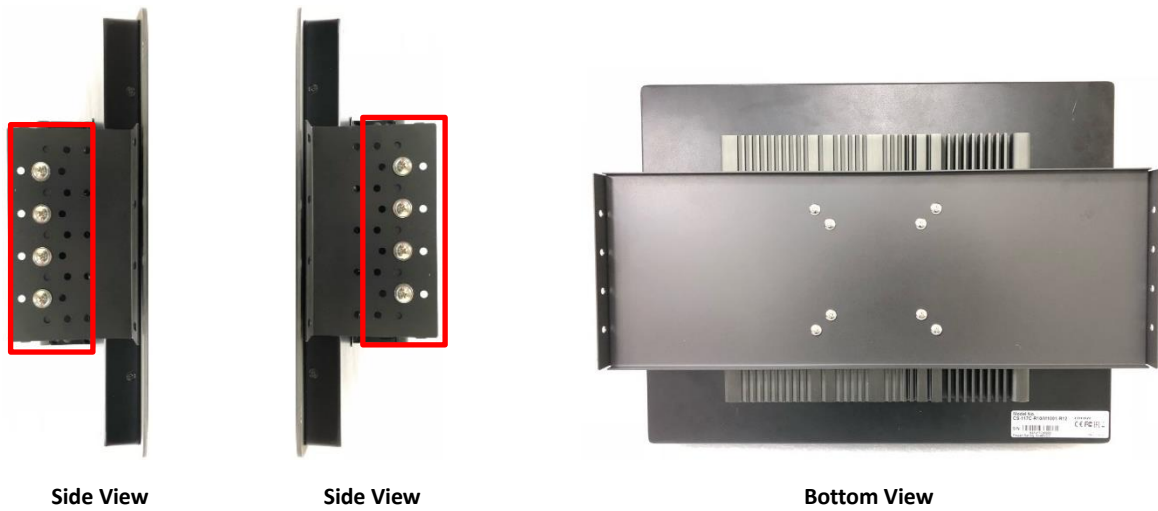

**For 19" ~ 24" Panel PC**

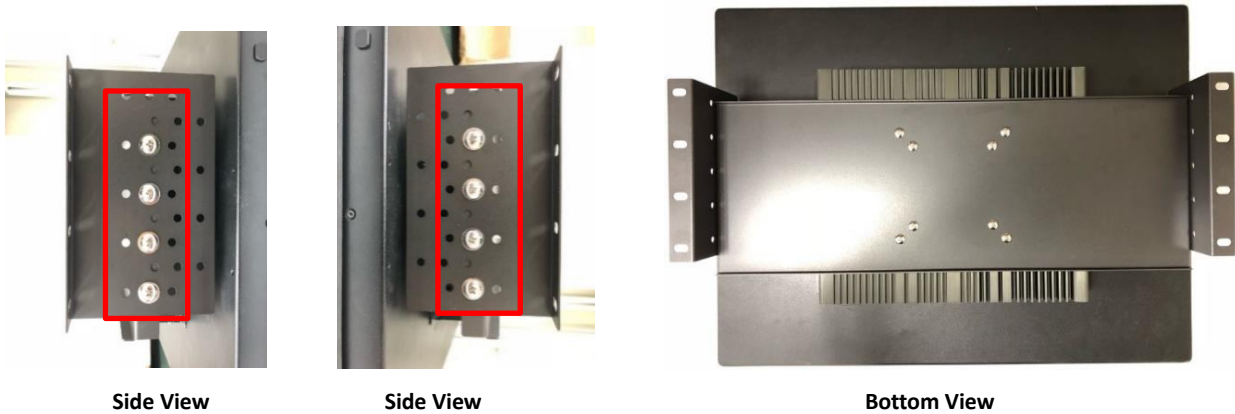



Step 4. Locate the mounting holes on the two rack mount brackets as shown below for example.



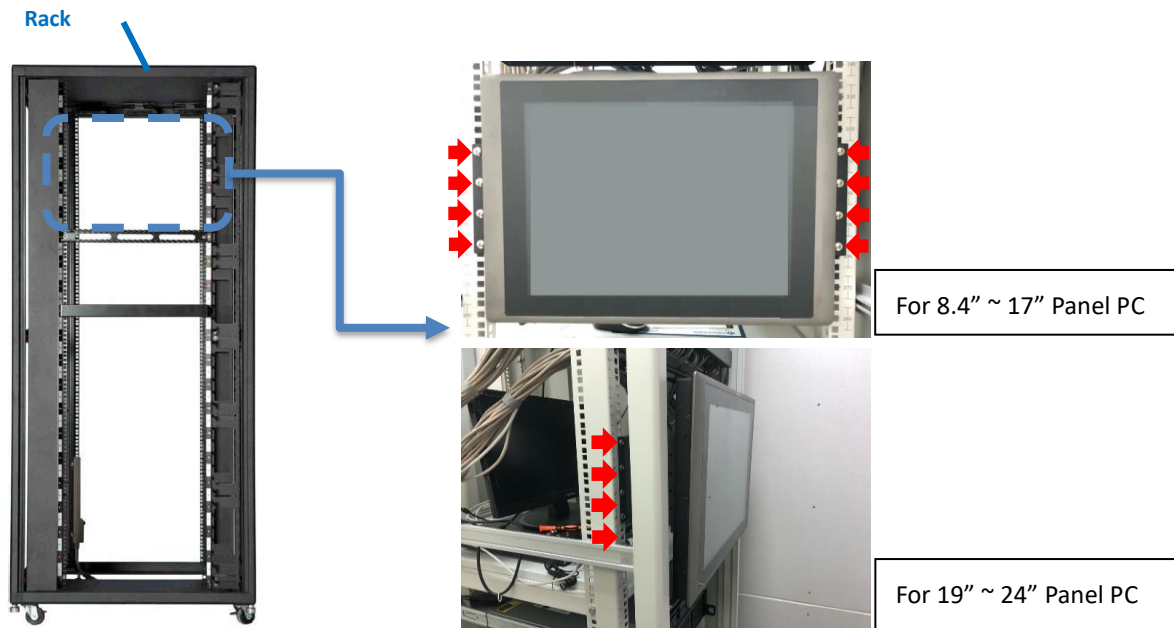

Step 5. And then assemble two rack mount brackets and the rack by fastening 4 M5x12 screws, flat washers and hex nuts at each side.





# **Chapter 4**

## **BIOS Setup**

## 4.1 BIOS Introduction

The BIOS (Basic Input/ Output System) is a program located on a Flash Memory on the motherboard. When you start the computer, the BIOS program will gain control. The BIOS first operates an auto-diagnostic test called POST (power on self-test) for all the necessary hardware, it detects the entire hardware device and configures the parameters of the hardware synchronization.

### BIOS Setup

Power on the computer and by pressing <Del> immediately allows you to enter Setup. If the message disappears before your respond and you still wish to enter Setup, restart the system to try again by turning it OFF then ON or pressing <Ctrl>, <Alt> and <Delete> keys.

Control Keys	
<<> <>>	Move to select screen
<↑> <↓>	Move to select item
<Esc>	Quit the BIOS Setup
<Enter>	Select item
<Page Up/+>	Increases the numeric value or makes changes
<Page Down/->	Decreases the numeric value or makes changes
<Tab>	Select setup fields
<F1>	General help
<F2>	Previous value
<F3>	Load Optimized defaults
<F10>	Save configuration and Exit

### Main Menu

The main menu lists the setup functions you can make changes to. You can use the arrow keys ( ↑ ↓ ) to select the item. The on-line description of the highlighted setup function is displayed at the bottom of the screen.

### Sub-Menu

If you find a right pointer symbol appears to the left of certain fields that means a sub-menu can be launched from this field. A sub-menu contains additional options for a field parameter. You can use arrow keys ( ↑ ↓ ) to highlight the field and press <Enter> to call up the sub-menu. Then you can use the control keys to enter values and move from field to field within a sub-menu. If you want to return to the main menu, just press the <Esc >.

## 4.2 Main Setup

Press <Del> to enter BIOS CMOS Setup Utility, the Main Menu (as shown below) will appear on the screen. Use arrow keys to move among the items and press <Enter> to accept or enter a sub-menu.

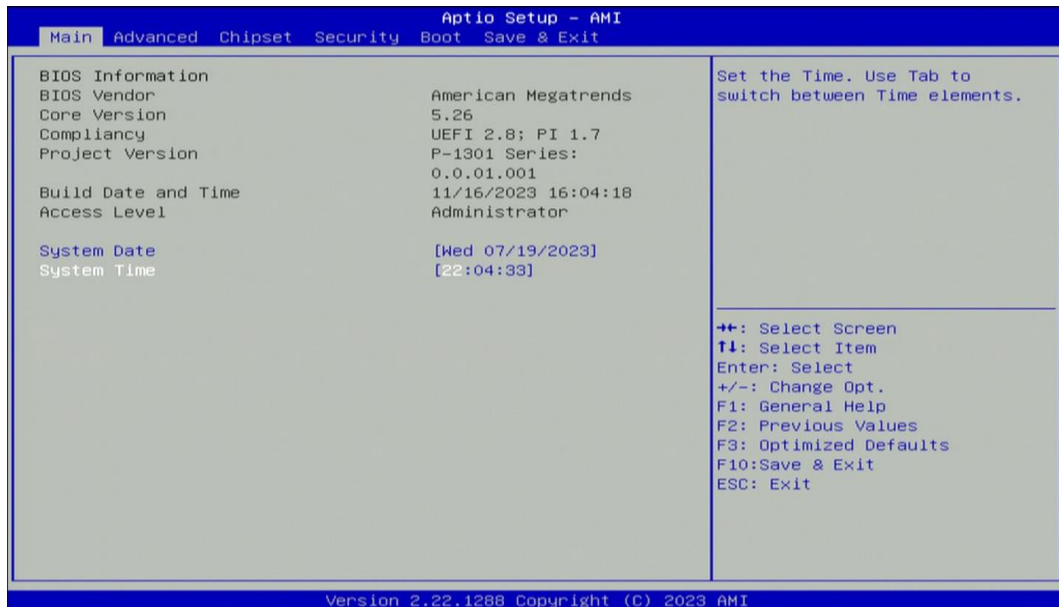

### ■ System Date

Set the date. Please use <Tab> to switch between date elements.

### ■ System Time

Set the time. Please use <Tab> to switch between time elements.

## 4.3 Advanced Setup

This section allows you to configure and improve your system and allows you to set up some system features according to your preference.

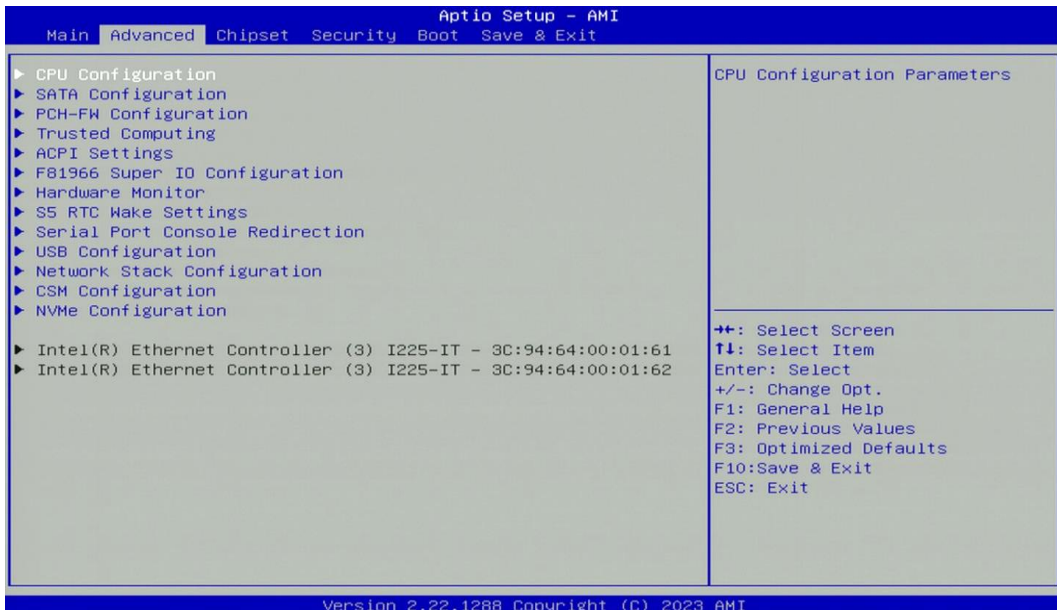

### 4.3.1 CPU Configuration



#### ■ Intel (VMX) Virtualization Technology [Enabled]

Enables or disables Intel Virtualization Technology. Virtualization enhanced by Intel Virtualization Technology will allow a platform to run multiple operating systems and applications in independent partitions. With virtualization, one computer system can function as multiple virtual systems.

#### ■ Active Processor Cores [All]

Number of cores to enable in each processor package.

## 4.3.2 SATA Configuration

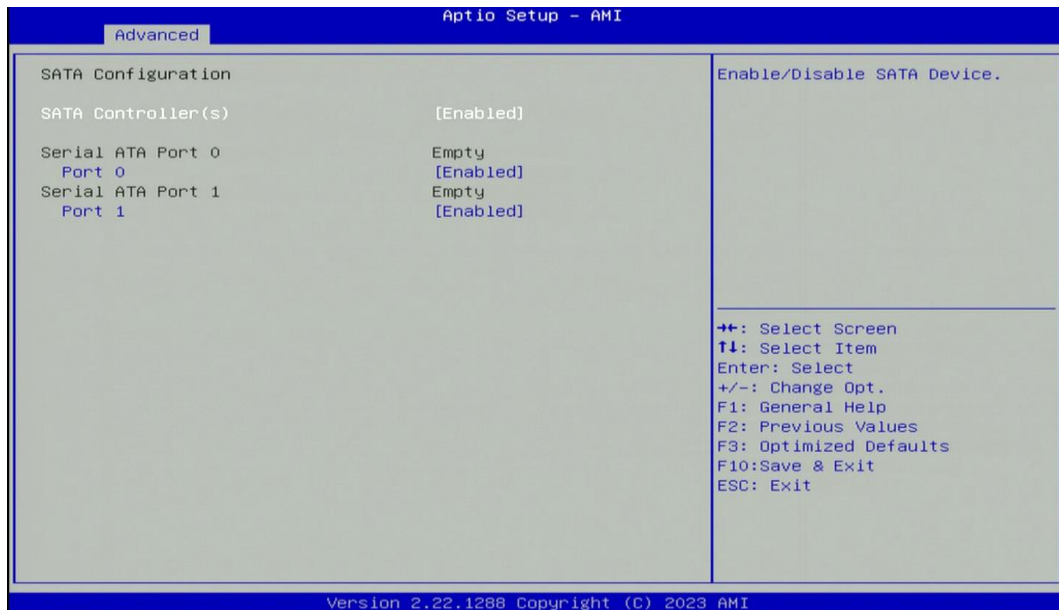

### ■ SATA Controller(s) [Enabled]

Enables or disables SATA device.

### ■ SATA Mode Selection [AHCI]

Allows you to select which mode SATA controller will operate.

Configuration options: [AHCI]

#### Serial ATA Port 0

##### Port 0 [Enabled]

Enables or disables SATA Port 0.

#### Serial ATA Port 1

##### Port 1 [Enabled]

Enables or disables SATA Port 1.

## 4.3.3 PCH-FW Configuration



## ■ Firmware Update Configuration

Configure Management Engine Parameters

### ❑ Me FW Image Re-Flash [Disabled]

Enables or disables ME firmware Image Re-Flash function.

## 4.3.4 Trusted Computing Settings

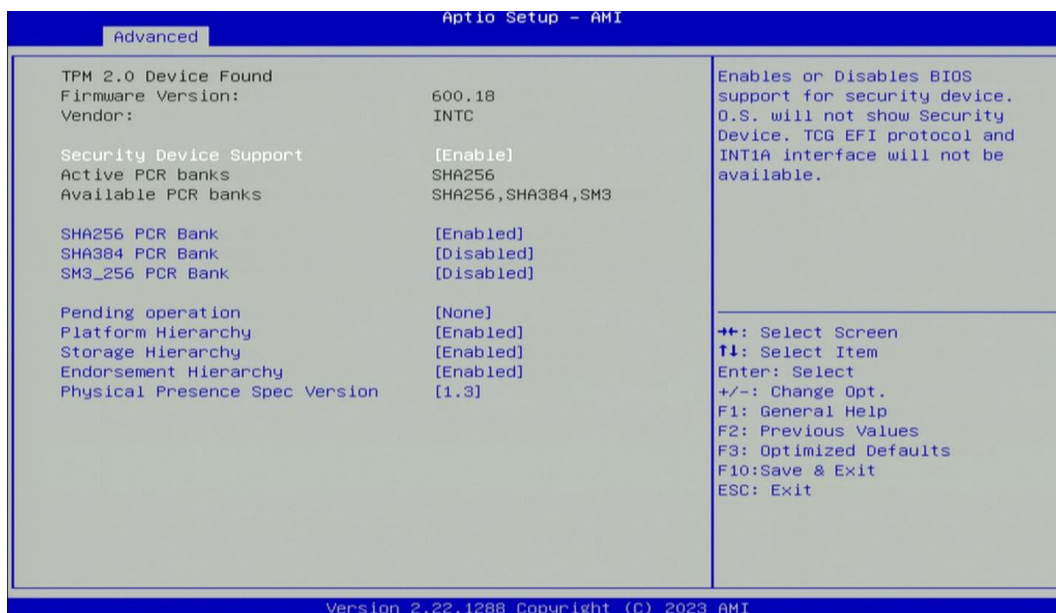

### ■ Security Device Support [Enabled]

Enables or disables Security Device Support function.

### ■ SHA256 PCR Bank [Enabled]

Enables or disables SHA256 PCR Bank function.

### ■ SHA384 PCR Bank [Disabled]

Enables or disables SHA384 PCR Bank function.

### ■ SM3\_256 PCR Bank [Disabled]

Enables or disables SM3\_256 PCR Bank function.

■ **Pending Operation [None]**

Allows you to select which mode Pending Operation will operate.

Configuration options: [None], [TPM Clear]

■ **Platform Hierarchy [Enabled]**

Enables or disables Platform Hierarchy function.

■ **Storage Hierarchy [Enabled]**

Enables or disables Storage Hierarchy function.

■ **Endorsement Hierarchy [Enabled]**

Enables or disables Endorsement Hierarchy function.

■ **Physical Presence Spec Version [1.3]**

Allows you to select which mode Physical Presence Spec Version will operate.

Configuration options: [1.2], [1.3]



### 4.3.5 ACPI Settings



#### ■ Enable Hibernation [Enabled]

Enables or disables system ability to hibernate state (OS/S4 state). This option may not be effective with some OS.

#### ■ ACPI Sleep State [S3 (Suspend to RAM)]

Allows users to select the highest Advanced Configuration Power Interface® (ACPI) sleep state that system will enter when suspend button is pressed.

[Suspend Disabled]: Disables entering suspend state.

[S3 (suspend to RAM)]: Enables suspend to RAM state.

### 4.3.6 F81966 Super IO Configuration

Set Parameters of Serial Ports. User can Enable/Disable the serial port and Select an optimal setting for the Super IO Device.



## ■ Serial Port 1~2 Configuration.

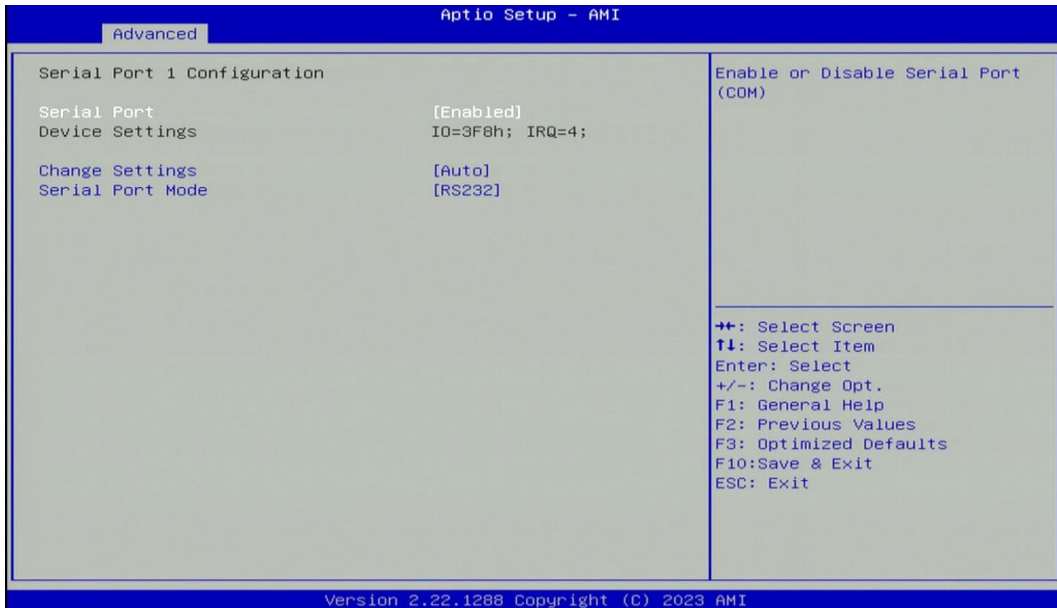

### Serial Port [Enabled]

Enables or disables serial port.

### Change Settings [Auto]

Allows you to change the IO Address & IRQ settings of the specified serial port.

### Serial Port Mode [RS232]

Allows you to select Serial Port Mode.

Configuration options: [RS232] [RS422/RS485 Full Duplex] [RS485 Half Duplex]

## ■ Watch Dog Mode [Sec]

Allows to set watchdog timer unit <Sec> or <Min>.

## ■ Watch Dog Timer [0]

Allows you to set watchdog timer's value in the range of 0 to 255.

### 4.3.7 Hardware Monitor

This screen displays the current status of all monitored hardware devices/components such as voltages, temperatures.

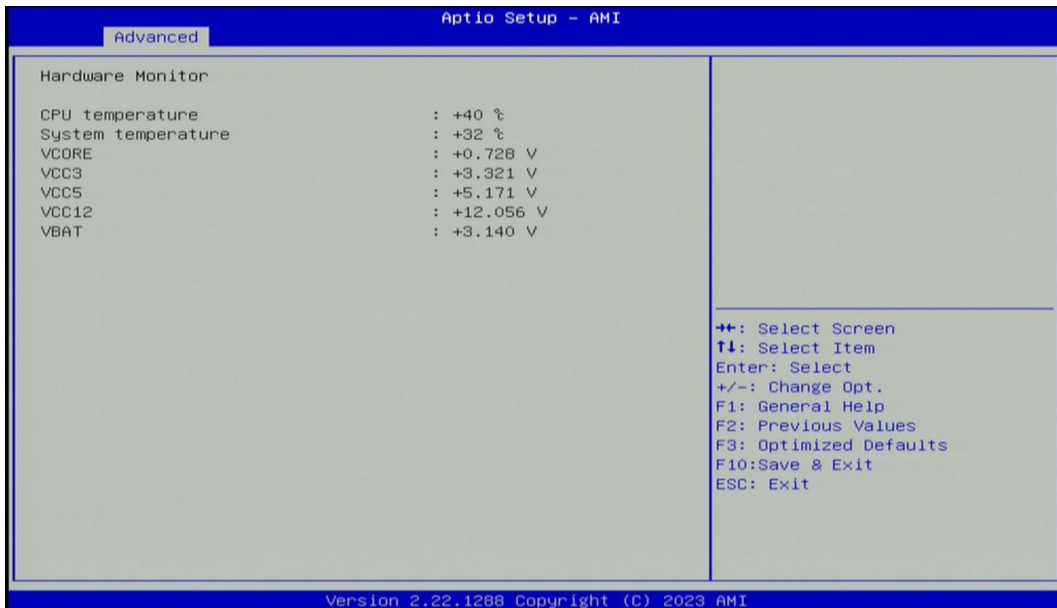

### 4.3.8 S5 RTC Wake Settings

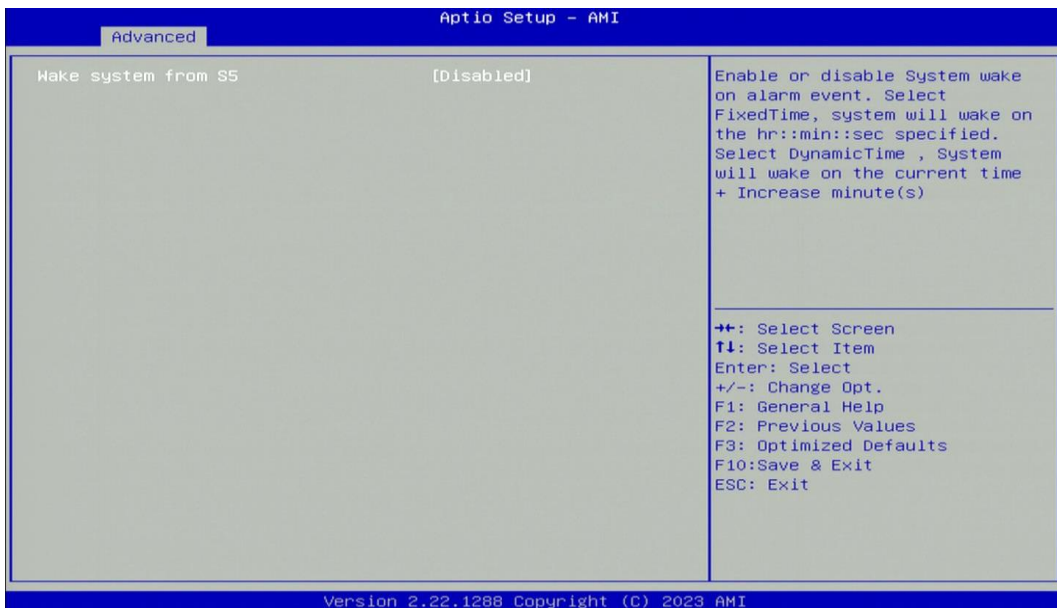

#### ■ Wake system from S5 [Disabled]

Enables or disables wake system from S5 (soft-off state).

[Disabled]: Disables wake system from S5.

[Fixed Time]: Sets a fixed time (HH:MM:SS) to wake system from S5.

[Dynamic Time]: Sets an increase minute(s) from current time to wake system from S5.

### 4.3.9 Serial Port Console Redirection



#### ■ Console Redirection [Disabled]

Allow users to enable or disable COM1, COM2, COM3 console redirection function.

### 4.3.10 USB Configuration

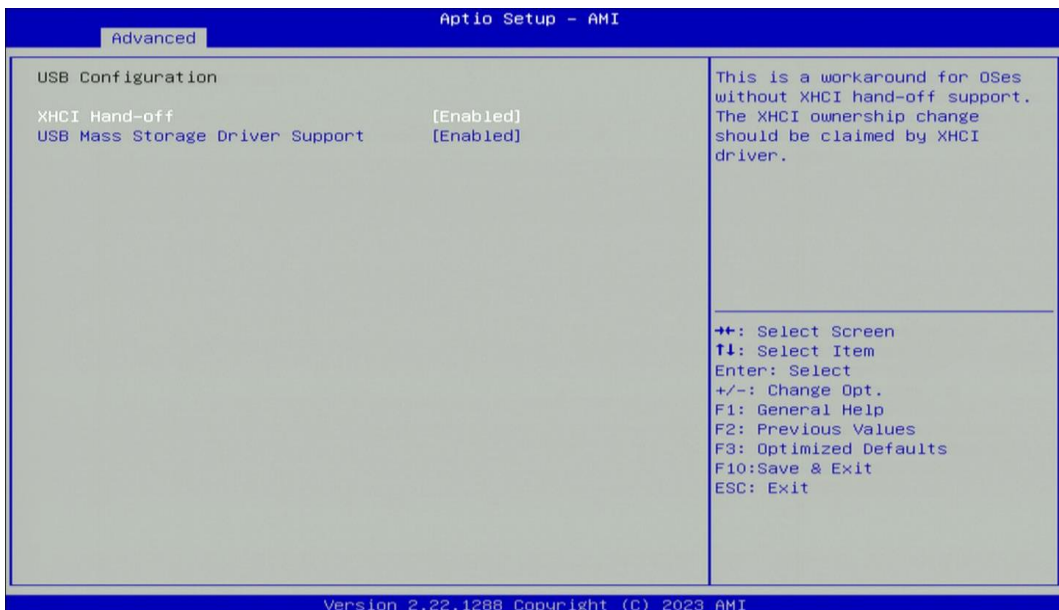

#### ■ XHCI Hand-off [Enabled]

Enables or disables XHCI (USB3.0) hand-off function. Use this feature as a workaround for operating systems without XHCI hand-off support.

#### ■ USB Mass Storage Driver Support [Enabled]

Enables or disables USB mass storage driver support.

### 4.3.11 Network Stack Configuration



#### ■ Network Stack [Disabled]

Enables or disables UEFI Network Stack.

### 4.3.13 CSM Configuration

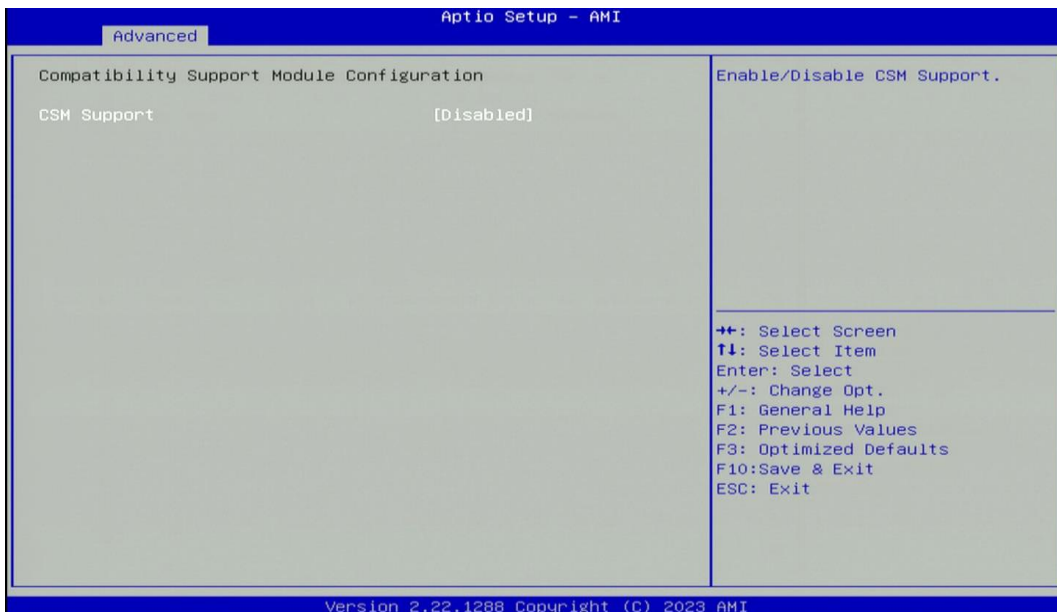

#### ■ CSM Support [Disabled]

Enables or disables compatibility support module.

### 4.3.14 NVMe Configuration

The screen allows users to select options for the NVMe configuration, and change the value of the selected option. If there is NVMe Device detected, the options will show as the NVMe Device is found.



## 4.4 Chipset Setup

This section allows you to configure chipset related settings according to user's preference.

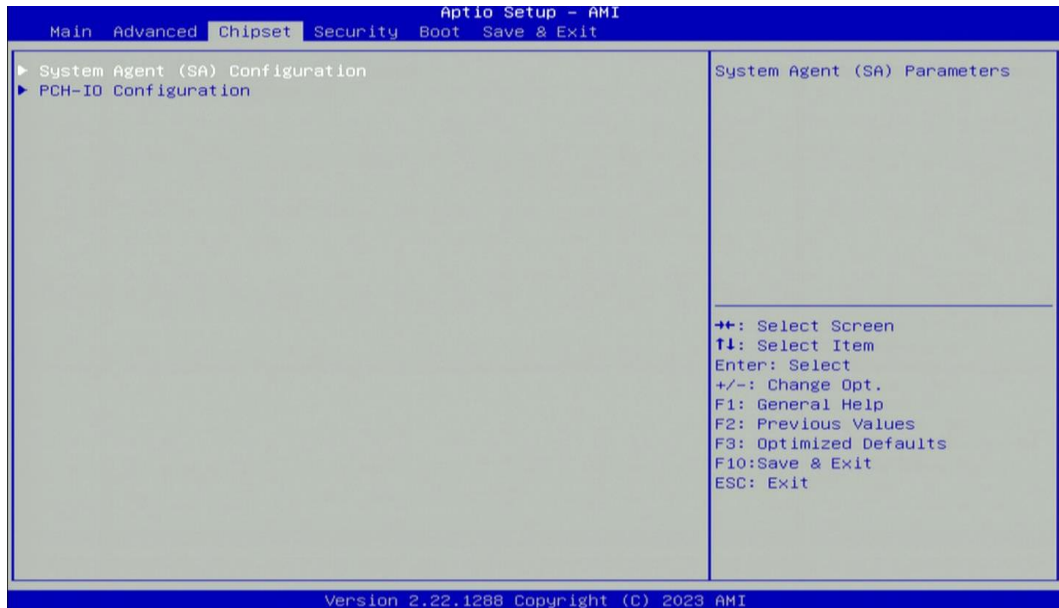

### 4.4.1 System Agent (SA) Configuration

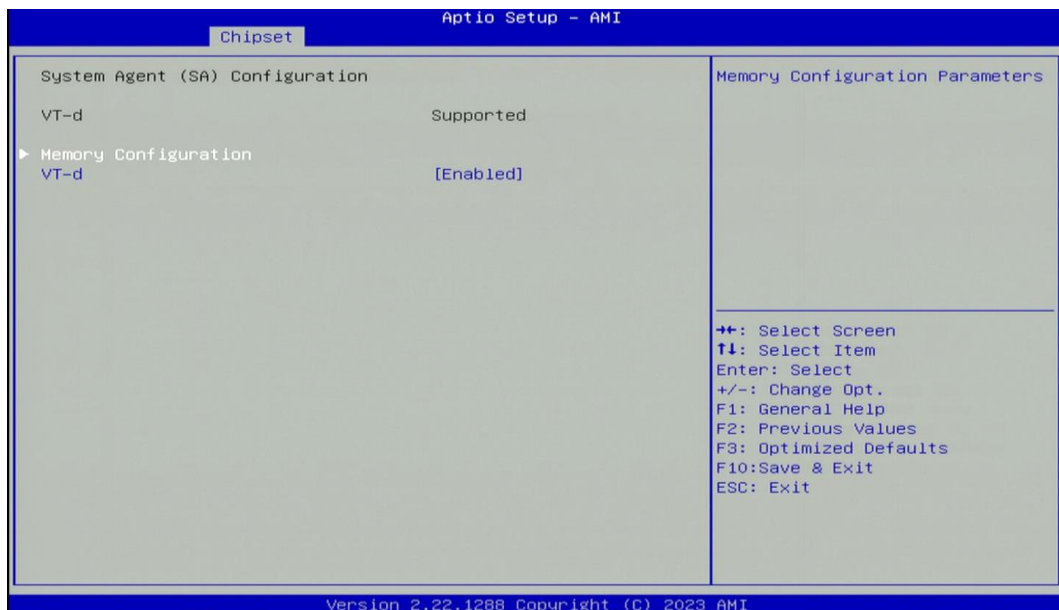

#### ■ Memory Configuration

This item displays detailed memory configuration in the system.

#### ■ VT-d [Enabled]

Enables or disables Intel® Virtualization Technology for Directed I/O (VT-d) capability.

## 4.4.2 PCH-IO Configuration

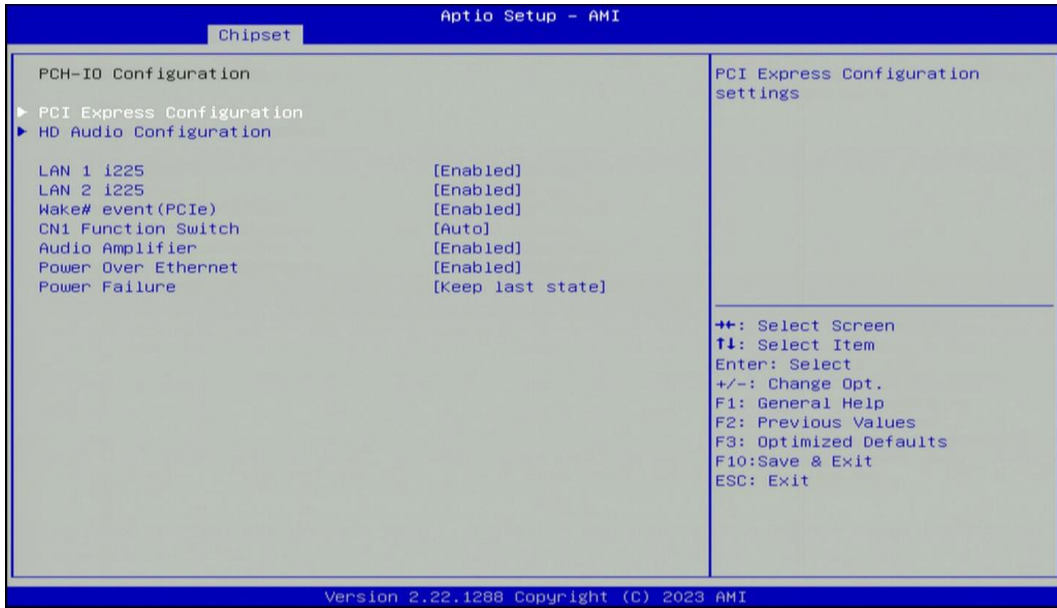

### ■ PCI Express Configuration

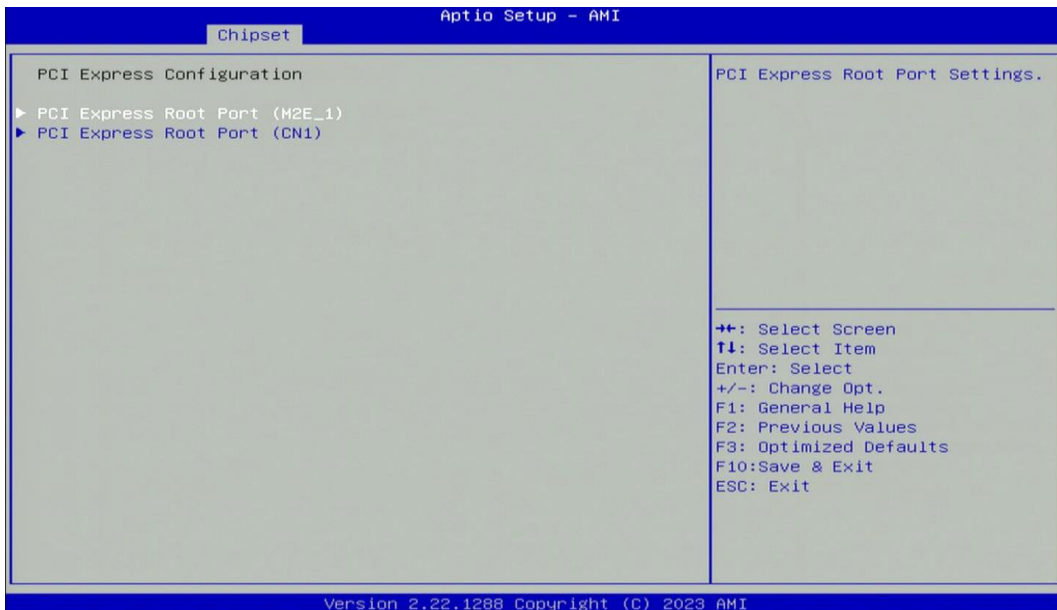

#### □ PCI Express Root Port (M2E\_1)

##### ■ PCI Express Root Port [Enabled]

Enables or disables PCI Express Root Port.

##### ■ PCIe Speed [Auto]

Allows you to select PCI Express interface speed.

Configuration options: [Auto] [Gen1] [Gen2] [Gen3].

#### □ PCI Express Root Port (CN1)

##### ■ PCI Express Root Port [Enabled]

Enables or disables PCI Express Root Port.

##### ■ PCIe Speed [Auto]

Allows you to select PCI Express interface speed.

Configuration options: [Auto] [Gen1] [Gen2] [Gen3].



## ■ HD Audio Configuration

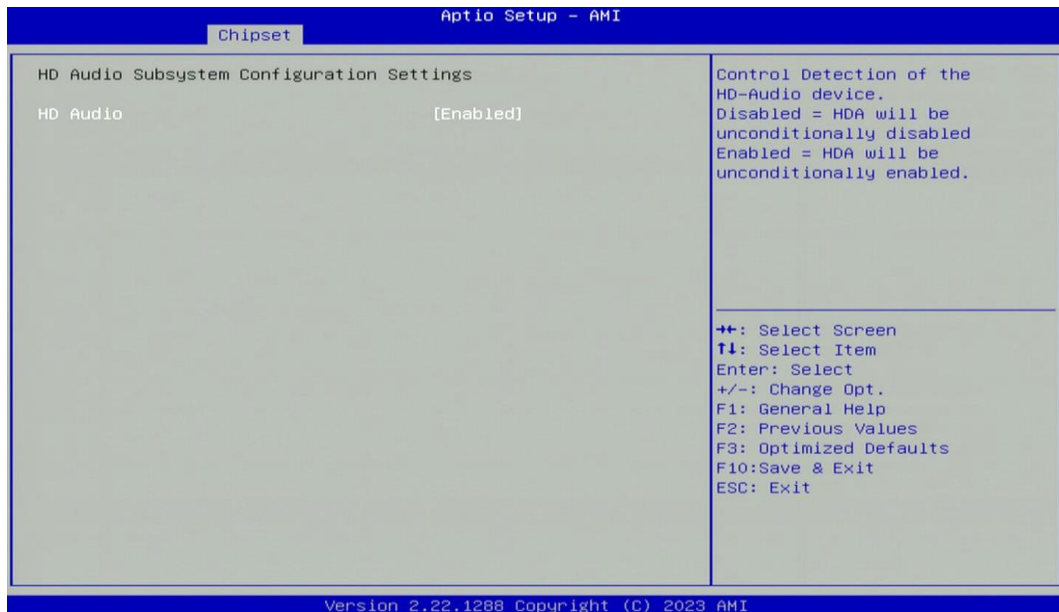

### ■ HD Audio [Enabled]

Enables or disables HD Audio function.

### ■ LAN 1 i225 [Enabled]

Enables or disables I210 LAN Controller.

### ■ LAN 2 i225 [Enabled]

Enables or disables I210 LAN Controller.

### ■ Wake# event (PCIe) [Enabled]

Enables or disables Wake# event (PCIe).

### ■ CN1 Function Switch [Auto]

Allows you to change **CN1 Function** as [Auto], [SSD-SATA], [SSD-PCIe], [WWAN-PCIe], or [WWAN-USB3].

### ■ Audio Amplifier [Enabled]

Enables or disables Audio Amplifier Function.

### ■ Power Over Ethernet [Enabled]

Enables or disables Power Over Ethernet Function.

### ■ Power Failure [Keep last state]

Allows you to specify which power state system will enter when power is resumed after a power failure (G3 state).

[Always on]: Enters to power on state.

[Always off]: Enters to power off state.

[Keep last state]: Enters to the last power state before a power failure.

## 4.5 Security Setup

This section allows users to configure BIOS security settings.

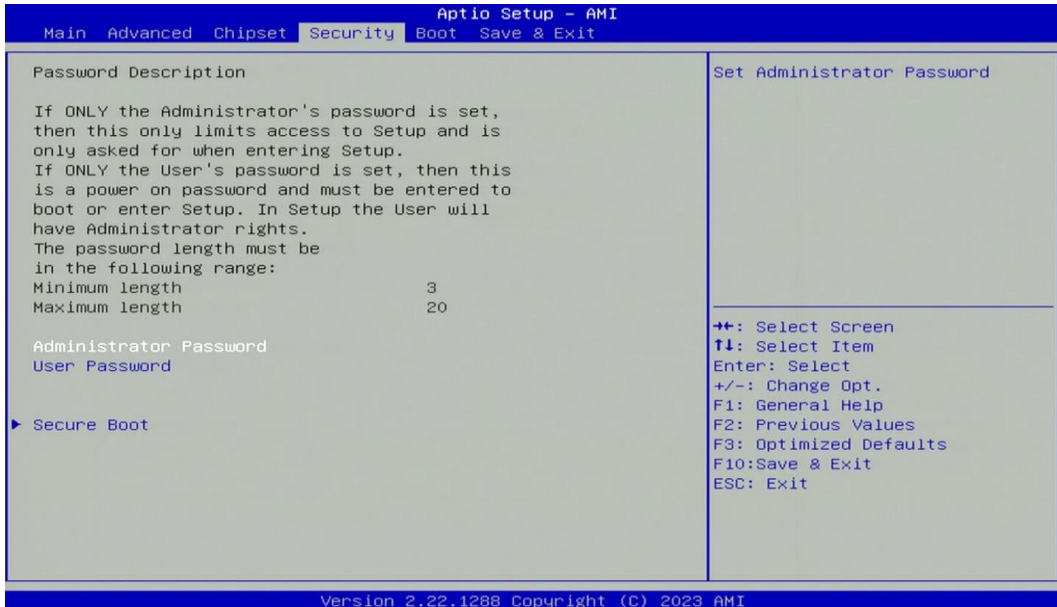

### ■ Administrator Password

Administrator Password controls access to the BIOS Setup utility.

### ■ User Password

User Password controls access to the system at boot and to the BIOS Setup utility.

### ■ Security Boot



#### Secure Boot [Disabled]

Enable or disable Secure Boot function. (Enable this function to change the following settings.)

#### Secure Boot Mode [Standard]

Allows you to select Secure Boot Mode.

Configuration options: [Standard] [Custom].

## 4.6 Boot Setup

This section allows you to configure Boot settings.

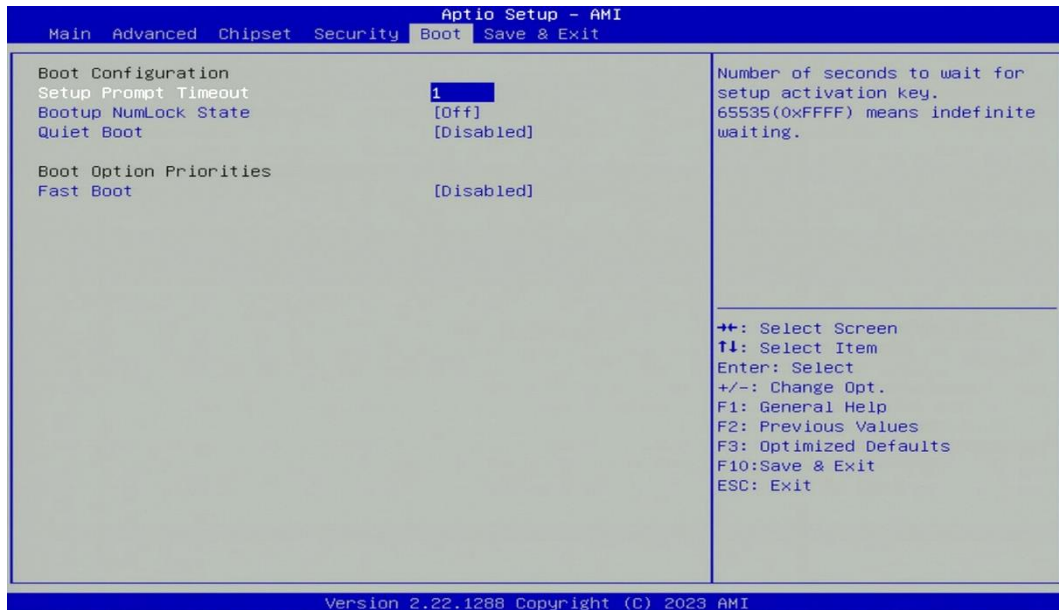

### ■ Setup Prompt Timeout [1]

Use this item to set number of seconds (1..65535) to wait for setup activation key.

### ■ Bootup NumLock State

Allows you to set NumLock key to [On] or [Off] state when system boots up.

### ■ Quiet Boot

Allows you to enable or disable Quiet Boot function.

### ■ Fast Boot

Allows you to enable or disable Fast Boot function. If enabled, system boots with initialization of a minimal set of devices required to launch active boot option.

## 4.7 Save & Exit

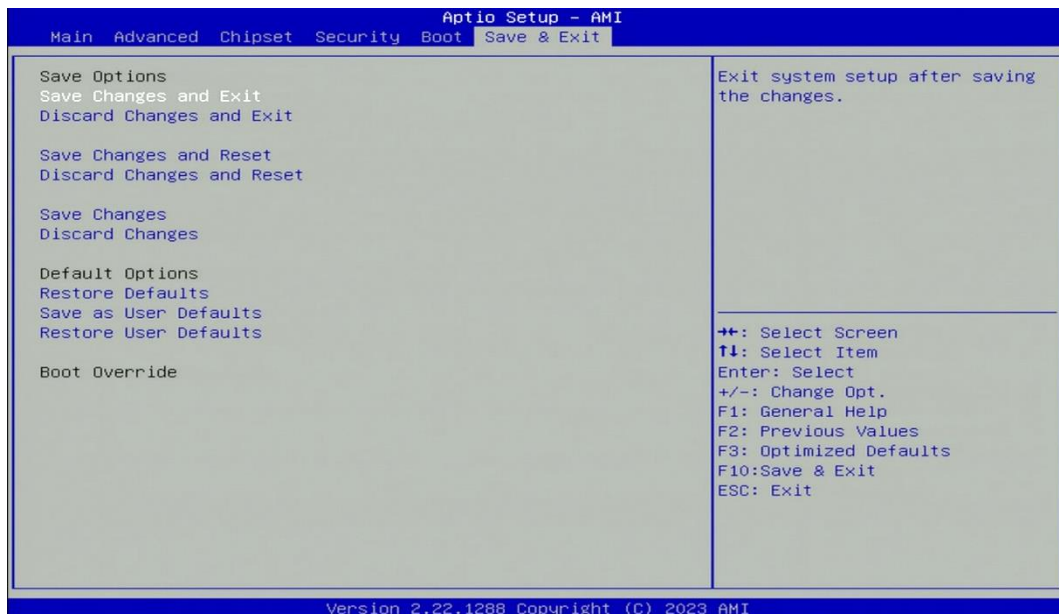

### ■ Save Changes and Exit

This item allows you to exit the system after saving changes.

### ■ Discard Changes and Exit

This item allows you to exit system setup without saving any changes.

### ■ Save Changes and Reset

This item allows you to reset the system after saving changes.

### ■ Discard Changes and Reset

This item allows you to reset system setup without saving any changes.

### ■ Save Changes

This item allows you to save changes.

### ■ Discard Changes

This item allows you to discard changes.

### ■ Restore Defaults

This item allows you to restore/ load default values for all the setup options.

### ■ Save as User Defaults

This item allows you to save the changes done so far as user defaults.

### ■ Restore User Defaults

This item allows you to restore the user defaults to all the setup options.



# **Chapter 5**

## **Product Application**

## 5.1 Where to download drivers?

Please go to the CINCOZE website to download the drivers for CS-100/P1301 series.

## 5.2 Where to find the technical documents?

Please go to the [CINCOZE website](#) to find the technical documents for CS-100/P1301 series.

Catalog	Document Title
Application Notes	DIO Application Guide
	DIO Technical Guide
	Instant Reboot Application Guide
	WDT Application Guide
	WDT Technical Guide
Configure & Installation	AT ATX Function Manual
	BIOS Administrator User Password Function Manual
	Clear CMOS Function Manual
	COM Function Manual
	CSM Function Manual
	Digital I/O Function Manual
	How to import Secure Boot Key?
	How to restore Windows image with Clonezilla?
	How to set TPM function under Windows?
	How to stop automatic driver update in Windows SOP
	How to Update BIOS and ME under UEFI shell?
	How to Update BIOS under UEFI shell?
	How to Update BIOS under Windows?
	IGN Module User Manual
	Intel AMT with KVM Remote Control
	POE Module User Manual
	PXE Function Manual
	RAID Function Manual
	Remote Switch Function Manual
	Wake On LAN Function Manual
WDT Function Manual	

***cincoze***

© 2024 Cincoze Co., Ltd. All rights reserved.

The Cincoze logo is a registered trademark of Cincoze Co., Ltd.

All other logos appearing in this catalog are the intellectual property of the respective company, product, or organization associated with the logo.

All product specifications and information are subject to change without notice.